



Digital AC Motors MHD

Project Planning Manual

SYSTEM200



DOK-MOTOR*-MHD*****-PR03-EN-P

Title	Digital AC Motors
Type of documentation	Project Planning Manual
Documentation code	DOK-MOTOR*-MHD*****-PR03-EN-P
Internal file reference	<ul style="list-style-type: none"> drawing number: 120-1500-B307-03/EN
What is the purpose of this document?	<p>This document helps</p> <ul style="list-style-type: none"> in the familiarization with digital MHD AC motors to plan the mechanical integration into the installation to plan the electrical connections to connect the motor to order or identify a motor to determine the required motor cable and connector

Course of modifications

Document identification of previous and present output	Release Date	Comments
DOK-MOTOR*-MHD*****-PRJ1-EN-P	10.96	1 st edition
DOK-MOTOR*-MHD*****-PRJ2-EN-P	11.98	Newly included MHD041A, MHD071A, MHD090, MHD112, correction of technical data
DOK-MOTOR*-MHD*****-PR03-EN-P	09.99	Revision

Copyright	<p>© REXROTH INDRAMAT GmbH, 1999</p> <p>Transmission as well as reproduction of this documentation, commercial use or communication of its contents will not be permitted without expressed written permission. Violation of these stipulations will require compensation. All rights reserved for the issuance of the patent or registered design. (DIN 34-1)</p>
Validity	All rights are reserved with respect to the content of this documentation and the availability of the product.
Published by	<p>REXROTH INDRAMAT GmbH Bgm.-Dr.-Nebel-Str. 2 • D-97816 Lohr a. Main Telephone 09352/40-0 • Tx 689421 • Fax 09352/40-4885 http://www.rexroth.com/indramat Dept. ECM5(JW)</p>
Note	This document has been printed on chlorine-free bleached paper.

Contents

1	Introducing MHD AC Motors.....	1-1
1.1	General Features	1-1
1.2	Designs	1-3
1.3	Motor Feedback	1-4
2	Safety Instructions for Electrical Drives.....	2-1
2.1	Introduction.....	2-1
2.2	Hazards by improper use	2-2
2.3	General.....	2-3
2.4	Protection against contact with electrical parts and not grounded enclosures	2-4
2.5	Protection by protective low voltage (PELV) against electrical shock	2-5
2.6	Protection against dangerous movements.....	2-6
2.7	Protection against magnetic and electromagnetic fields during operations and mounting.....	2-7
2.8	Protection against contact with hot parts	2-8
2.9	Protection during handling and installation	2-8
2.10	Battery safety.....	2-9
3	Integrating Mechanically into the Installation	3-1
3.1	Installation Elevation and Ambient Temperature	3-1
3.2	Protection Category.....	3-2
	Selecting the Protection Category.....	3-4
	Selection List for Sealing Air Connection Accessories	3-5
3.3	Form and Mounting Position	3-6
3.4	Prime Coat and Housing Finish	3-6
3.5	Maximum Vibrations and Shock demands.....	3-6
3.6	Output Shafts	3-7
	Available types	3-7
	Shaft load	3-8
3.7	Surface Cooling.....	3-10
3.8	Liquid-Cooled MHD Motors.....	3-11
3.9	Holding Brake.....	3-11
3.10	Output Direction of the Electrical Connections.....	3-13
3.11	Speed/Torque Characteristics	3-14
4	Electrical Connections	4-1
4.1	An Overview of the Connections.....	4-1
4.2	Power Cables.....	4-2
4.3	Feedback Cables	4-12

4.4	Technical Data of Power and Feedback Cables.....	4-13
4.5	Individual Parts.....	4-14
5	Connections for Liquid-Cooling.....	5-1
5.1	Types of Connections.....	5-1
5.2	Connection Instructions.....	5-1
6	MHD041	6-1
6.1	Technical Data	6-1
6.2	Speed/Torque Characteristics.....	6-2
6.3	Data for Determining Maximum Shaft Load.....	6-4
6.4	Dimensional Data	6-5
6.5	Available Versions and Type Codes	6-6
7	MHD071	7-1
7.1	Technical Data	7-1
7.2	Speed/Torque Characteristics.....	7-2
7.3	Data for Determining Maximum Shaft Load.....	7-4
7.4	Dimensional Data	7-5
7.5	Available Versions and Type Codes	7-6
7.6	Surface cooling.....	7-7
8	MHD090	8-1
8.1	Technical Data	8-1
8.2	Speed/Torque Characteristics.....	8-2
8.3	Data for Determining Shaft Capacity.....	8-4
8.4	Dimensional Data	8-5
8.5	Available Versions and Type Codes	8-6
8.6	Surface cooling.....	8-7
9	MHD093	9-1
9.1	Technical Data	9-1
9.2	Speed/Torque Characteristics.....	9-3
9.3	Data on Determining Maximum Shaft Load	9-7
9.4	Dimensional Data (Standard cooling)	9-8
9.5	Dimensional Data (Liquid cooling)	9-9
9.6	Available Versions and Type Codes	9-10
9.7	Surface cooling.....	9-11
10	MHD112	10-1
10.1	Technical Data.....	10-1
10.2	Speed/Torque Characteristics.....	10-5
10.3	Data on Determining Maximum Shaft Load	10-9
10.4	Dimensional Data	10-10
10.5	Available Versions and Type Codes	10-12
10.6	Surface cooling.....	10-13

11	MHD115	11-1
11.1	Technical Data.....	11-1
11.2	Speed/Torque Characteristics	11-3
11.3	Data for Determining Maximum Shaft Load	11-6
11.4	Dimensional Data	11-7
11.5	Available Versions and Type Codes	11-9
11.6	Surface cooling.....	11-10
12	State at Delivery.....	12-1
12.1	General Information.....	12-1
12.2	Releasing the Taut Bands	12-1
12.3	Documentation.....	12-1
13	Identifying the Merchandise	13-1
13.1	Delivery Slip.....	13-1
13.2	Barcode Sticker	13-1
13.3	Type Plates.....	13-1
14	Storage, Transport and Handling.....	14-1
14.1	Notes on Packaging	14-1
14.2	Storage	14-1
14.3	Transport and Handling.....	14-2
15	Mounting and Installation	15-1
15.1	General Information on Mounting.....	15-1
15.2	Mounting the Motor.....	15-1
15.3	Connecting the Motor	15-1
	Connecting Ready-Made Cables	15-3
	Changing the Output Direction of Power and Feedback Connectors	15-4
15.4	Connecting and Mounting the Blower Connector.....	15-7
15.5	Cleaning the Holding Brakes.....	15-8
16	Service Guidelines	16-1
16.1	Maintenance	16-1
16.2	Contacting Customer Service.....	16-1
16.3	Fault Report.....	16-1
17	Index	17-1
18	Kundenbetreuungsstellen - Sales & Service Facilities	18-1

1 Introducing MHD AC Motors

1.1 General Features

Application range MHD digital AC motors in conjunction with digital intelligent drive controllers from INDRAMAT create cost-effective automation systems that make available an extensive range of functionalities for such areas as

- machine tools
- transfer machines
- handling systems
- printing machines
- packaging machines and
- textile machines

Advantages The following advantages distinguish MHD motors:

- High operating reliability
- Maintenance-free operation (due to the brushless design and bearings lubricated for their entire service life)
- Can be used even under adverse environmental conditions (due to the completely sealed motor design with a protection category of IP 65)
- Overload protection (due to motor temperature monitoring)
- High power data
- High dynamics (due to favorable torque/inertia ratio)
- High overload capabilities (due to favorable heat conduction away from the stator windings to the outside wall of the motor housing)
- Peak torque can be used over a broad speed range (due to electronic commutation)
- Continuous start-stop operations with high repetitive frequencies are possible (electronic commutation)
- Mounting into the machine is easy (due to the flange that meets the requirements as specified in DIN 42948)
- Any mounting orientation is possible
- Direct attachment of pinions and belt pulleys to the shaft as the design makes it possible to apply high radial loads
- Simple cable routing (due to ready-made cables which are available in a variety of versions)
- Simple and quick commissioning (due to data memory in the motor feedback)

Power overview Motors with the following continuous torques at standstill and rated speeds are available:

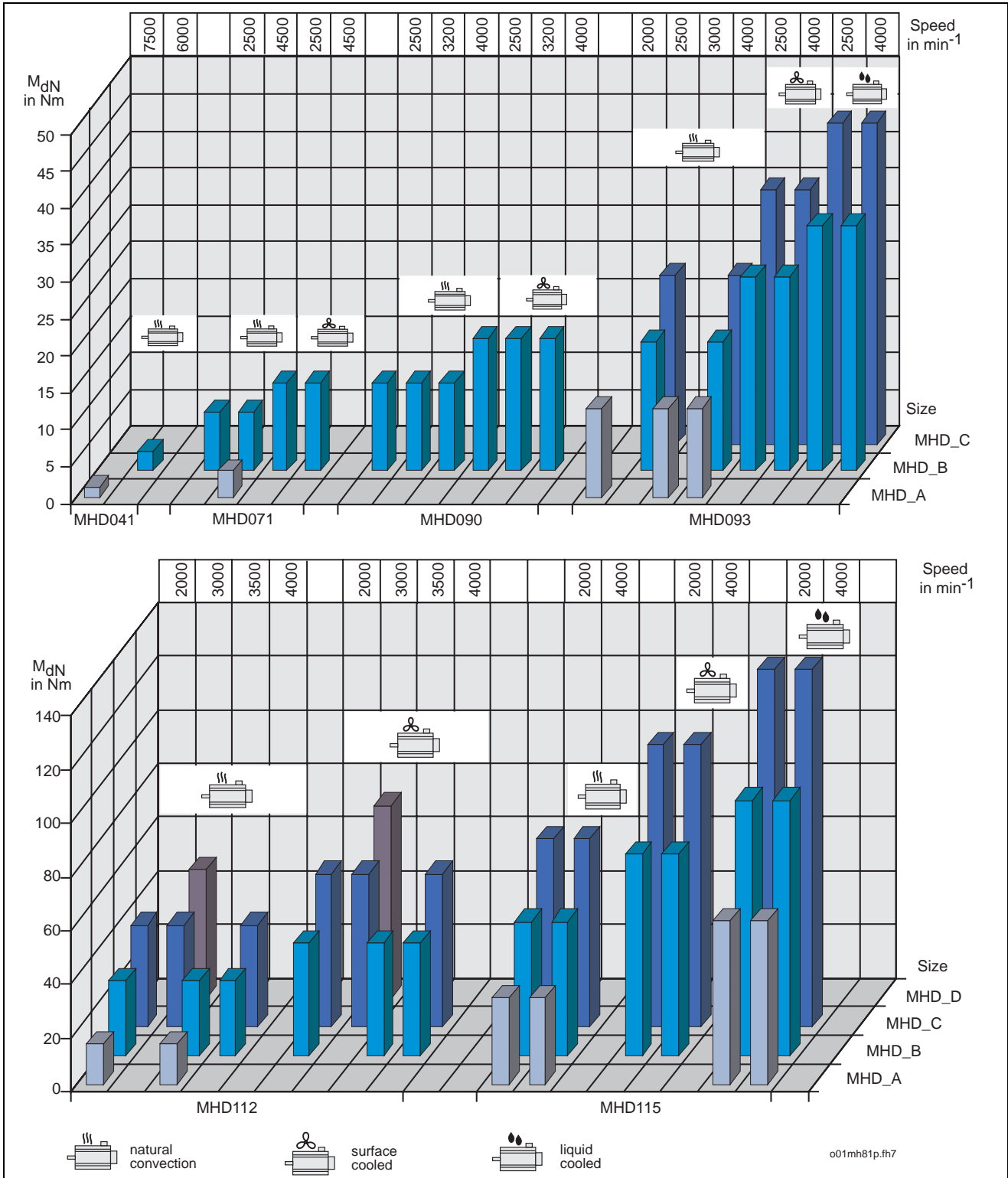

Fig. 1-1: Continuous torque at standstill for the available MHD motors

Construction and Components MHD motors are permanent magnet-excited motors with electronic commutation. Special magnetic materials permit a design with low inertial mass. The following illustration illustrates the basic structure of MHD motors.

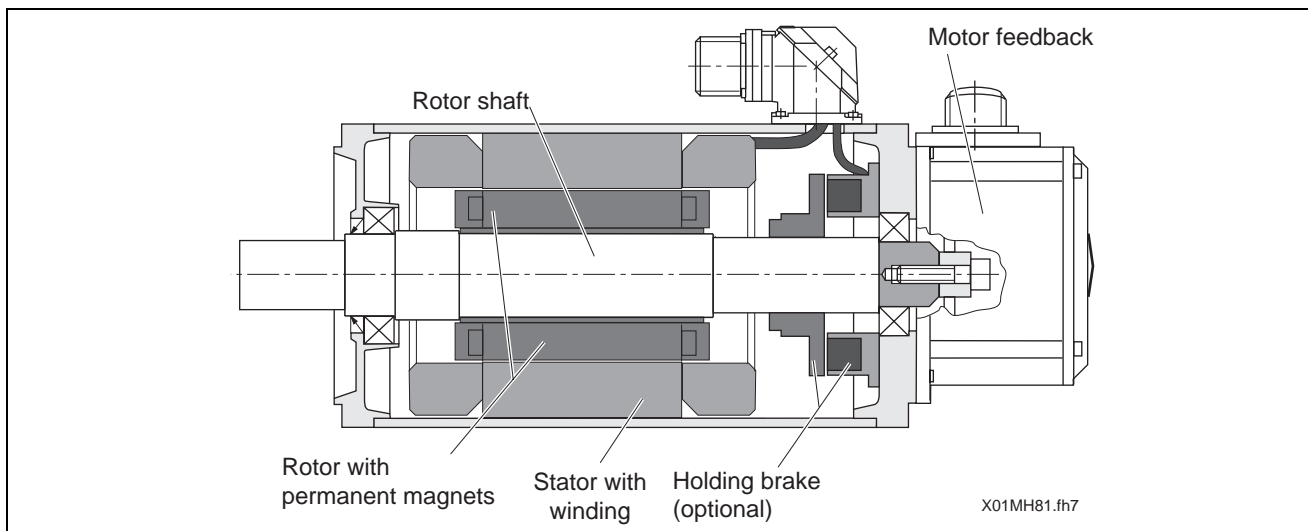

Fig. 1-2: The structure of an MHD motor

1.2 Designs

MHD motors are available in various designs:

- Motor feedback** They are available with
- relative rotor position detection (standard) or
 - absolute rotor position detection (option).
- For further details see section Motor Feedback, 1.3 .
- Holding brake** Option. For a safe standstill of the axis when no power is being applied to the motor. For further details see section 15.5 .
- Output shaft** They are available with
- plain shaft (standard) or
 - shaft with keyway (option).
- For further details see section 3.6 .
- Cooling method** The following types of motor can be cooled in some way other than the standard one of „natural convection“:
- surface cooling (MHD071, MHD090, MHD093, MHD112 and MHD115)
 - liquid cooling (MHD093 and MHD115)
- For further details see sections 3.7 or 3.8 .

1.3 Motor Feedback

The drive controller needs the current motor position to control motor speed and to position.

The integrated motor feedback supplies the drive controller with the appropriate signals. Controllers are generally able to transmit the determined position value to a higher-ranking CNC or PLC.

Feedback data memory

The feedback electronics are equipped with data memory in which motor type designations, control loop and motor parameters are stored.

INDRAMAT's digital intelligent drive controllers can read this data. This ensures a

- rapid and simple start-up
- and adjustments between motor and drive controllers without the danger of damage to the motor.

MHD motors are available with two position evaluation types

- relative position detection or
- absolute position detection.

Technical data of the motor feedback

Designation	Digital servo feedback (HSF)	Digital servo feedback (HSF) with integral multiturn absolute encoder
Measuring principle	optical	
Position resolution on motor	$512 \times 2^{13} = 4\,194\,304$ information/revolution	
System accuracy	± 0.5 angular minutes	
Type of position detection	relative	absolute (over 4096 motor revolutions)

Fig. 1-3: Technical data of motor feedback

Note: MKD motors are available for lesser demands.

Digital servo feedback (HSF)

For relative indirect position detection: Replaces a separate incremental encoder on the motor.

Features of the digital servo feedback: After a power failure or after the initial POWER ON it is necessary to first run to the axis to home before work can begin.

Digital servo feedback (HSF) with integral multiturn absolute encoder

For absolute indirect position detection within 4096 motor revolutions. Replaces a separate absolute encoder on the motor.

The absolute position of the axis is retained with this feedback variant even after power to the installation has been shutdown.

2 Safety Instructions for Electrical Drives

2.1 Introduction

These instructions must be read and understood before the equipment is used to minimize the risk of personal injury and / or property damage. Follow these safety instructions at all times.

Do not attempt to install, use or service this equipment without first reading all documentation provided with the product. Please read and understand these safety instructions, and all user documentation of the equipment, prior to working with the equipment at any time. You must contact your local Indramat representative if you cannot locate the user documentation for your equipment. A listing of Indramat offices is supplied in the back of this manual. Request that your representative send this documentation immediately to the person or persons responsible for the safe operation of this equipment.

If the product is resold, rented and/or otherwise transferred or passed on to others, then these safety instructions must accompany it.



WARNING

Improper use of this equipment, failure to follow the attached safety instructions, or tampering with the product, including disabling of safety device, may result in personal injury, severe electrical shock, death, or property damage!

2.2 Hazards by improper use



DANGER

High voltage and high discharge current!

Danger to life, risk of severe electrical shock and risk of injury!



DANGER

Dangerous movements!

Danger to life and risk of injury or equipment damage by unintentional motor movements!



WARNING

High electrical voltages due to incorrect connections!

Danger to life, severe electrical shock and serious bodily injury!



WARNING

Health hazard for persons with heart pacemakers, metal implants and hearing aids in proximity to electrical equipment!



CAUTION

**Surface of machine housing could be extremely hot!
Danger of injury! Danger of burns!**



CAUTION

Risk of injury due to incorrect handling!

Bodily injury caused by crushing, shearing, cutting and thrusting movements!



CAUTION

Risk of injury due to incorrect handling of batteries!

2.3 General

- INDRAMAT GmbH is not liable for damages resulting from failure to observe the warnings given in these instructions.
- Operating, maintenance and safety instructions in English must be ordered and received before initial start-up, if the instructions in the language provided are not understood perfectly.
- Proper and correct transport, storage, assembly, and installation as well as care in operation and maintenance are prerequisites for optimal and safe operation of this equipment.
- Trained and qualified personnel in electrical equipment:

Only trained and qualified personnel may work on this equipment or within its proximity. Personnel are qualified if they have sufficient knowledge of the assembly, installation, and operation of the product as well as an understanding of all warnings and precautionary measures noted in these instructions.

Furthermore, they should be trained, instructed, and qualified to switch electrical circuits and equipment on and off, to ground them, and to mark them according to the requirements of safe work practices and common sense. They must have adequate safety equipment and be trained in first aid.

- Use only spare parts approved by the manufacturer.
- All safety regulations and requirements for the specific application must be followed as practiced in the country of use.
- The equipment is designed for installation on commercial machinery.
- Start-up is only permitted once it is sure that the machine in which the product is installed complies with the requirements of national safety regulations and safety specifications of the application.

European countries: see Directive 89/392/EEC (Machine Guideline).

- Operation is only permitted if the national EMC regulations for the application are met.

The instructions for installation in accordance with EMC requirements can be found in the INDRAMAT document "EMC in Drive and Control Systems".

The machine builder is responsible for compliance with the limiting values as prescribed in the national regulations and specific EMC regulations for the application.

European countries: see Directive 89/336/EEC (EMC Guideline).

U.S.A.: See National Electrical Codes (NEC), National Electrical Manufacturers Association (NEMA), and local building codes. The user of this equipment must consult the above noted items at all times.

- Technical data, connections, and operational conditions are specified in the product documentation and must be followed.

2.4 Protection against contact with electrical parts and not grounded enclosures

Note: This section pertains to equipment and drive components with voltages over 50 Volts.

Touching live parts with potentials of 50 volts and higher applied to them or touching not grounded enclosures can be dangerous and cause severe electrical shock. In order for electrical equipment to be operated, certain parts must have dangerous voltages applied to them.



High Voltage!

Danger to life, severe electrical shock and risk of injury!

- ⇒ Only those trained and qualified to work with or on electrical equipment are permitted to operate, maintain and / or repair this equipment.
- ⇒ Follow general construction and safety regulations when working on electrical installations.
- ⇒ Before switching on power, the ground wire must be permanently connected to all electrical units according to the connection diagram.
- ⇒ At no time may electrical equipment be operated if the ground wire is not permanently connected, even for brief measurements or tests.
- ⇒ Before beginning any work, disconnect mains or the voltage source from the equipment. Lock the equipment against being switched on while work is being performed.
- ⇒ Wait five (5) minutes after switching off power to allow capacitors to discharge before beginning work. Measure the voltage on the capacitors before beginning work to make sure that the equipment is safe to touch.
- ⇒ Never touch the electrical connection points of a component while power is turned on.
- ⇒ Before switching the equipment on, install those covers and guards provided with the equipment to prevent contact with live parts. Before operating, cover and guard live parts properly so they cannot be touched.
- ⇒ A residual-current-operated protective device (r.c.d.) must not be used on an AC drive! Indirect contact must be prevented by other means, for example, by an overcurrent protective device.

European countries: according to EN 50178/ 1994.

- ⇒ Electrical components with exposed live parts must be installed in a control cabinet to prevent direct contact.

European countries: according to EN 50178/ 1994.

U.S.A: See National Electrical Codes (NEC), National Electrical Manufacturers Association (NEMA), and local building codes. The user of this equipment must consult the above noted items at all times.

**DANGER****High housing voltage! High leakage current!**

Danger to life and limb, danger of injury from electric shock!

- ⇒ Prior to powering up, connect the electrical equipment, the housing of all electrical units and motors to the protective conductor at the grounding points or ground them. This applies even to brief tests.
- ⇒ The protective conductor of the electrical equipment and units must always be connected to the supply network. Leakage current exceeds 3.5 mA.
- ⇒ Use at least a 10 mm² copper conductor cross section for this protective connection over its entire course!
- ⇒ Prior to startups, even for brief tests, always connect the protective conductor or connect with ground wire. High voltage levels can occur on the housing that could lead to severe electrical shock and personal injury.

European countries: EN 50178 / 1994, section 5.3.2.3.

USA: See National Electrical Codes (NEC), National Electrical Manufacturers Association (NEMA), and local building codes. The user of this equipment must consult the above noted items at all times.

2.5 Protection by protective low voltage (PELV) against electrical shock

All connections and terminals with voltages ranging between 5 and 50 volts on INDRAMAT products are protective low voltages designed in accordance with the following standards on contact safety:

- International: IEC 364-4-411.1.5
- EU countries: see EN 50178/1994, section 5.2.8.1.

**WARNING****High electrical voltages due to incorrect connections!**

Danger to life, severe electrical shock and/or serious bodily injury!

- ⇒ Only that equipment or those electrical components and cables may be connected to all terminals and clamps with 0 to 50 volts that are of the protective low voltage type (PELV = Protective Extra Low Voltage).
- ⇒ Only connect those voltages and electrical circuits that are safely isolated. Safe isolation is achieved, for example, with an isolating transformer, an optoelectronic coupler or when battery-operated.

2.6 Protection against dangerous movements

Dangerous movements can be caused when units have bad interfaces or motors are connected incorrectly.

There are various causes of dangerous movements:

- Improper or incorrect wiring or cable connections
- equipment is operated incorrectly
- probe parameters or encoder parameters are set incorrectly
- malfunctioning components
- errors in software or firmware

Dangerous movements can occur immediately after equipment is switched on or even after an unspecified time of trouble-free operation.

Although the monitoring circuits in the drive components make improper operation almost impossible, personnel safety requires that proper safety precautions be taken to minimize the risk of personal injury and/or property damage. This means that unexpected motion must be anticipated since safety monitoring built into the equipment might be defeated by incorrect wiring or other faults.



Dangerous movements!

Danger to life and risk of injury or equipment damage!

- ⇒ In the drive component monitoring units, every effort is made to avoid the possibility of faulty operation in connected drives. Unintended machine motion or other malfunction is possible if monitoring units are disabled, bypassed or not activated.
- ⇒ Safe requirements of each individual drive application must be considered on a case-by-case basis by users and machine builders.

Avoiding accidents, personal injury and/or property damage:

- ⇒ Keep free and clear of the machine's range of motion and moving parts. Prevent people from accidentally entering the machine's range of movement:
 - use protective fences
 - use protective railings
 - install protective coverings
 - install light curtains / barriers
- ⇒ Fences should be strong enough to withstand maximum possible momentum.
- ⇒ Mount the Emergency Stop (E-stop) switch in the immediate reach of the operator. Verify that the emergency stop works before startup. Do not operate the machine if it is not working.
- ⇒ Isolate the drive power connection by means of an emergency stop circuit or use a start inhibit system to prevent unintentional start-up.

- ⇒ Make sure that the drives are brought to standstill before accessing or entering the danger zone.
 - ⇒ Disconnect electrical power to the equipment using a master lock-out and secure against reconnection for:
 - maintenance and repair work
 - cleaning of equipment
 - long periods of discontinued equipment use
 - ⇒ Avoid operating high-frequency, remote control, and radio equipment near equipment electronics and supply leads. If use of such equipment cannot be avoided, verify the system and the plant for possible malfunctions at all possible positions of normal use before the first start-up. If necessary, perform a special Electromagnetic Compatibility (EMC) test on the plant.
-

2.7 Protection against magnetic and electromagnetic fields during operations and mounting

Magnetic and electromagnetic fields in the vicinity of current-carrying conductors and permanent motor magnets represent a serious health hazard to persons with heart pacemakers, metal implants and hearing aids.



WARNING

Health hazard for persons with heart pacemakers, metal implants and hearing aids in proximity to electrical equipment!

- ⇒ Persons with pacemakers and metal implants are not permitted to have access to the following areas:
 - Areas in which electrical equipment and parts are mounted, being operated or started up.
 - Areas in which parts of motors with permanent magnets are being stored, repaired or mounted.
 - ⇒ If it is necessary for a person with a pacemaker to enter into such an area, then a physician must be consulted prior to doing so.
 - ⇒ Persons with metal implants or hearing aids must take care prior to entering into areas described above. It is assumed that metal implants or hearing aids will be affected by such areas: A physician must be consulted prior to working in and/or entering such areas.
-

2.8 Protection against contact with hot parts

2.9 Protection during handling and installation

All INDRAMAT products should be handled and assembled according to the instructions in the documentation.



CAUTION

Risk of injury due to incorrect handling!

Bodily injury caused by crushing, shearing, cutting, and thrusting movements!

- ⇒ Observe installation instructions and safety regulations before handling and working on the product.
 - ⇒ Use suitable lifting or moving equipment during installation. Refer to the user manual for the product.
 - ⇒ Take precautions to avoid pinching and crushing.
 - ⇒ Only use suitable tools specified in the user manuals and use them according to the instructions.
 - ⇒ Use lifting devices and tools correctly and safely.
 - ⇒ Wear appropriate protective clothing, e.g., protective goggles, safety shoes, protective gloves.
 - ⇒ Never stand under suspended loads.
 - ⇒ Clean up liquids from the floor to prevent personnel from slipping.
-

2.10 Battery safety

Batteries contain reactive chemicals. Incorrect handling can result in injury or equipment damage.



CAUTION

Risk of injury due to incorrect handling!

- ⇒ Do not attempt to reactivate dead batteries by heating or other methods (danger of explosion and corrosion).
 - ⇒ Never charge batteries (danger from leakage and explosion).
 - ⇒ Never throw batteries into a fire.
 - ⇒ Do not take batteries apart.
 - ⇒ Handle carefully. Incorrect extraction or installation of a battery can damage equipment.
-

Note: Environmental protection and disposal! The batteries contained in the product should be considered as hazardous material for land, air and sea transport in the sense of the legal requirements (Danger of explosion). Dispose of batteries separately from other refuse. Observe the legal requirements in the country of installation.

3 Integrating Mechanically into the Installation

3.1 Installation Elevation and Ambient Temperature

- Nominal data** The power data specified for the motor apply to
- ambient temperatures of 0° to +45° C
 - installation elevations of 0 to 1000 m above sea level.

Exceeding nominal data If the motors are used above the specified range then the „Load factors“ must be taken into account. This derates power data.

⇒ In cases such as this, check whether the power data remain sufficient for your application. To determine load factors, see Fig. 3-1. Values higher than shown for temperature or elevation are basically not allowed!

Note: Motor damage and loss of guarantee!

- Motors operated outside of range specified could be damaged. Doing so also means that the guarantee is lost. Please note the following instructions!
-

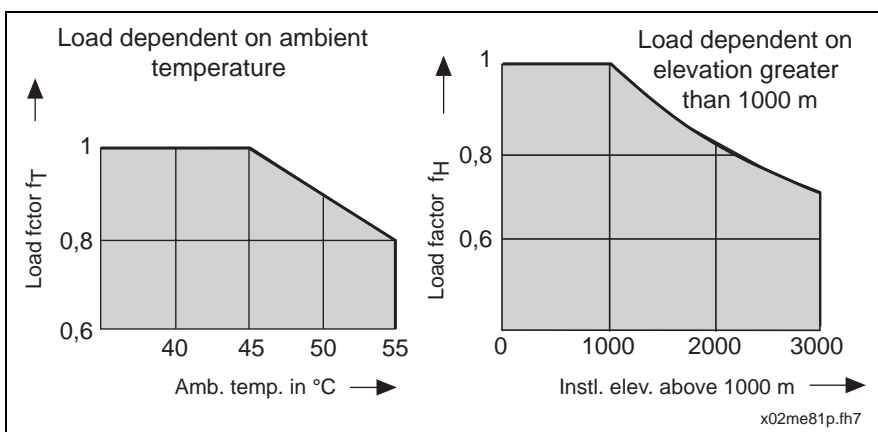

Fig. 3-1: Load factor as dependent on ambient temperature and installation elevation

If **either** ambient temperature **or** installation elevation exceed nominal data:

- ⇒ then multiply the torque specified in the selection data with the determined load factor.
- ⇒ Ensure that the derated torque data are not exceeded by your application.

If **both** the ambient temperature **and** installation elevation exceed nominal data, then

- ⇒ multiply the determined load factors f_T and f_H .
- ⇒ Multiply that value with the motor torque data specified in the selection data.

Make sure that the derated torque is not exceeded by your application.

3.2 Protection Category

The design of MHD motors meets the following protection categories as specified in DIN VDE 0470, part 1, edition dated 11/1992 (EN 60 529):

Motor ranges	Protection	Comment
Motor housing, drive shaft, power and feedback connections (only with correct mounting)	about IP67	with sealing air option
Motor housing, drive shaft, power and feedback connections (only with correct mounting)	IP 65	Standard
Blower motor	IP 44	Standard
Surface blower (blower grid) and blower connection	IP 24	Standard

Fig. 3-2: Protection categories of the motors

The protection category is specified with IP (International Protection) and two numbers for the level of protection.

The **first number** describes the protection against contact and penetration of extrinsic objects. The **second one** describes the level of protection against water.

First number	Protection
6	protection against dust penetration (dust proof); complete protection against contact
4	protection against penetration of solid extrinsic objects having a diameter exceeding 1 mm
2	protection against penetration of solid extrinsic objects having a diameter exceeding 12 mm ⇒ Keep fingers or similar objects away from unit!
Second number	Protection
7	protection against damaging effects with brief submersions into water
5	protection against a jet of water from a nozzle coming from all directions pointed at housing (jet of water)
4	protection against water coming from all directions against the housing

Fig. 3-3: IP protection categories

Note: The checks for the second number are conducted with fresh water. If cleaning processes use higher pressure or solvents, lubricants or other types of oils, then a higher protection category may become necessary.

Option: Sealing air

For some motors, sealing air connections are available. These are mounted by simply replacing them with the motor flange socket lid on the motor. By generating a specific overpressure in the inside of the motor, the penetration of oils or aggressive lubricants is reliably prevented.

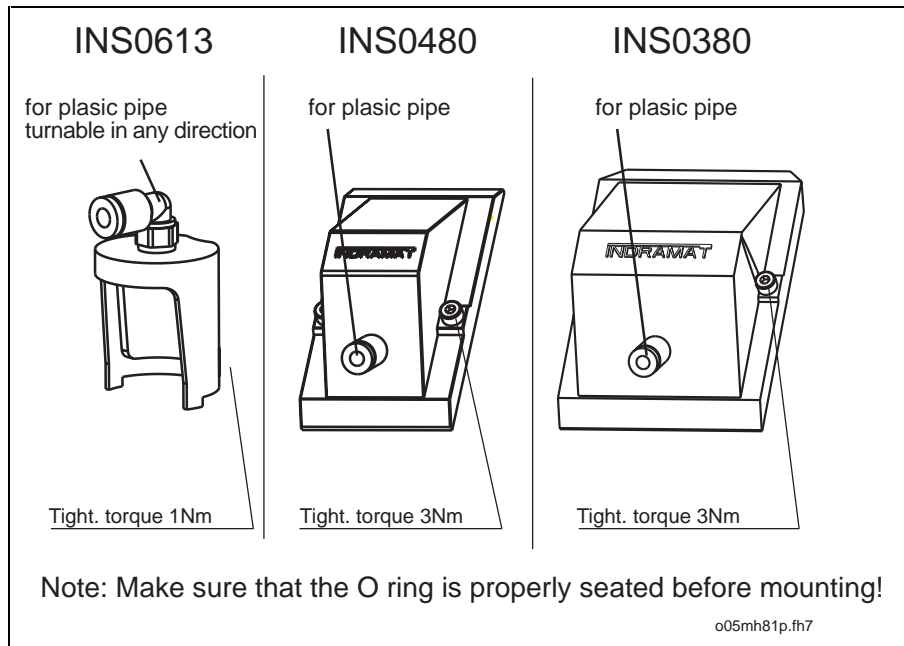

Fig. 3-4: Motor flange socket lid with sealing air connection

Note: When mounting the sealing air connection make sure that the O-ring is properly seated. Only if all mounting is performed correctly can the protection category be ensured.

Compressed air data

Pressure	0.1...0.2 bar, max. 0.3 bar
Air	dust and oil free
Relative humidity	20...30%

Supplier recommendation plastic pipe

Rexroth Mecmann Pneumatik GmbH
 Barweg 13
 30453 Hannover
 Tel: +49 (0)511 21 36 0
 Fax: +49 (0)511 21 36 269
 Plastic pipe type **PA 4x 0.75**

Size [mm]	Length [m]	Color	Order number
4 x 0.75	25	blue	281 520 402 0
	50	blue	281 520 405 0

Fig. 3-5: Plastic pipe

Accessories kit designation The available motor flange socket lid with sealing air connection is listed in the following table.

Motor flange socket (type)	Accessories designation for sealing air connection
INS0480 (power connection)	SUP-M01-MHD
INS0380 (power connection)	SUP-M02-MHD
INS0613 (feedback connection)	SUP-M03-MHD

Fig. 3-6: Accessories for sealing air connection

**WARNING****Danger to personnel or damage to property!**

Poorly executed power and feedback connections can injure personnel or damage property!

⇒ Make sure that the power and feedback connections are properly seated.

⇒ Use the motors only in that environment for which the specified protection category is sufficient.

Selecting the Protection Category

The protection category depends on the mounting position and the application.

Use the following table to help decide which protection category is best for your application.

Effect	Medium	Recommended protection category
dry	air	IP65
humid	water; general lubricants with oil (about 5%)	IP65
	oils, bio-oils aggressive lubricants	IP65 with sealing air (about IP67)
surge	water; general lubricants with oils (about 5%)	IP65 with sealing air (about IP67)
	oils, bio-oils aggressive lubricants	IP65 with sealing air (about IP67)

Fig. 3-7: Protection category selection

Selection List for Sealing Air Connection Accessories

The following list offers an overview of which motor the sealing air option can be used with.

Sealing air connections are not available for those not listed. Note this when selecting your motor.

Overview of accessories: sealing air connections for MHD motors				
Motor type	INS0613	INS0480	INS0380	Accessories for sealing air connections
MHD 041 A-144	X			SUP-M03-MHD
MHD 041 B-144	X			SUP-M03-MHD
MHD 071 A-061	X			SUP-M03-MHD
MHD 071 B-035	X			SUP-M03-MHD
MHD 071 B-061	X			SUP-M03-MHD
MHD 090 B-035	X			SUP-M03-MHD
MHD 090 B-047	X			SUP-M03-MHD
MHD 090 B-058	X			SUP-M03-MHD
MHD 093 A-035		X		SUP-M01-MHD
MHD 093 A-058		X		SUP-M01-MHD
MHD 093 B-035		X		SUP-M01-MHD
MHD 093 B-058		X		SUP-M01-MHD
MHD 093 C-035		X		SUP-M01-MHD
MHD 093 C-058		X		SUP-M01-MHD
MHD 112 A-024		X		SUP-M01-MHD
MHD 112 A-058		X		SUP-M01-MHD
MHD 112 B-024		X		SUP-M01-MHD
MHD 112 B-048		X		SUP-M01-MHD
MHD 112 B-058		X		SUP-M01-MHD
MHD 112 C-024		X		SUP-M01-MHD
MHD 112 C-058			X	SUP-M02-MHD
MHD 112 D-027		X		SUP-M01-MHD
MHD 115 A-024			X	SUP-M02-MHD
MHD 115 A-058			X	SUP-M02-MHD
MHD 115 B-024			X	SUP-M02-MHD
MHD 115 B-058			X	SUP-M02-MHD
MHD 115 C-024			X	SUP-M02-MHD
MHD 115 C-058			X	SUP-M02-MHD

Fig. 3-8: Sealing air accessories for MHD motors

3.3 Form and Mounting Position

Form: B05 for flange mounting

Position: any

Per DIN IEC 34-7, ed. 12/1992 the following mounting positions are allowed:

- IM B5 (horizontal)
- IM V1 (vertical, drive shaft downward)
- IM V3 (vertical, drive shaft upward)

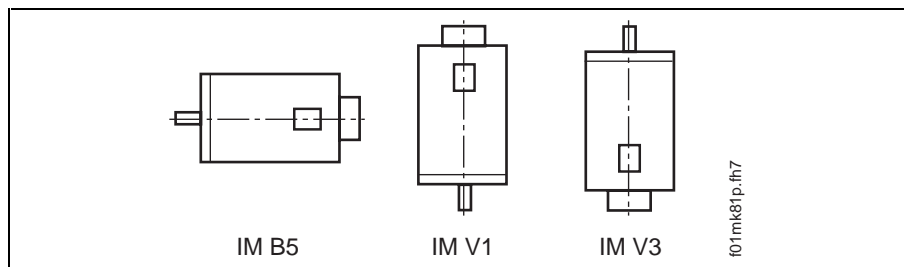

Fig. 3-9: Mounting position



Penetration of liquids!

Liquids can collect in motors mounted as per IM V3 over extended periods of time at the drive shaft. These can penetrate the motor and cause damage.

⇒ Make sure that this cannot happen.

3.4 Prime Coat and Housing Finish

State at delivery: basic coat black (RAL 9005)

Resistance: against weathering, yellowing, chalking, undiluted acids and alkaline solutions.

An additional coat of paint may be applied (thickness max. 40 µm).

3.5 Maximum Vibrations and Shock demands

MHD motors are only suited for those demands such as are typical for pressing, stamping and press feeds if they have been mounted in a shock-proof fashion. The construction of these depends on how the machine is used and they should be subsequently tested.

Note: Motor damage and loss of guarantee!

- Motors operated outside of specified ranges can be damaged. The guarantee in such cases is also forfeited, therefore, please note the following instructions!

Per IEC 721-3-3, ed. 1987 or EN 60721-3-3, ed. 06/1994 MHD motors may be used stationary and weather-protected under the following conditions:

- Motor vertical axis: per class 3M1
- Motor lateral axis: per class 3M6

⇒ Make sure that the motors do not exceed the limit values specified for storage, transport and operation. See Fig. 3-10 and Fig. 3-11.

Variable	Unit	Maximum value of vertical axis	Maximum value of lateral axis
Amplitude of displacement at 2 to 9 Hz	mm	0.3	7.0
Amplitude of acceleration at 9 to 200 Hz	m/s ²	1	20

Fig. 3-10: Limit data for sinusoidal vibrations

Variable	Unit	Maximum value of vertical axis	Maximum value of lateral axis
total shock response spectrum (per IEC721-1, ed. 1990; table 1, sec. 6)		type L	type II
reference accel (in IEC 721 peak accel specified)	m/s ²	40	250
Duration	ms	22	6

Fig. 3-11: Shock load limit values

Note: Motors with mounted blower are **not suited** for applications with shock loads such as occur with

- stamping
- pressing or
- gantry axes

In such cases, motors without surface cooling and higher torques should be used.

3.6 Output Shafts

Available types

Plain output shaft

For a backlash free and formfitting transmission of torque.

⇒ Use clamping blocks, pressure sleeves or other clamping devices to couple pinions, belt discs or similar drive components.

Output shaft with keyway (Per DIN 6885, sh.1; ed. 08/1968). For formfitting transmission of torque with low demands made of shaft/hub connection.

Note: Shaft could be damaged!

- During forceful reverse operations, the keyway could swing out. Any deformations within this area can then lead to a break in the shaft. It is therefore advisable to use a plain output shaft.

Shaft load

Radial and axial forces effect the output shaft:

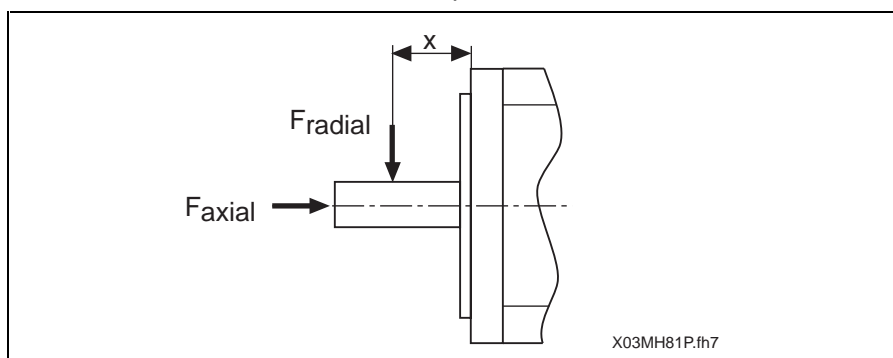

Fig. 3-12: Shaft load forces

Note: Motor damage and loss of guarantee!

- Excessive shaft loads can damage the motors and shorten bearing service life. The guarantee is also lost, therefore, please note the following instructions!

Maximum allowed radial force $F_{\text{radial_max}}$

The maximum allowed radial force $F_{\text{radial_max}}$ depends on shaft break load. It is determined in terms of distance x of the point of application of force and the design of the output shaft (plain shaft or one with keyway).

Sections to contain "Data to determine maximum shaft load" sections.

- ⇒ Using those characteristics determine maximum allowed radial force $F_{\text{radial_max}}$ for your application.
- ⇒ Make sure that the radial force determined is not exceeded at any time during operation.

Allowed radial force F_{radial}

The allowed radial force F_{radial} depends on the bearing service life wanted. It is fixed in terms of the arithmetically determined speed of the motor n_{mittel} and distance x of the point of application of force (see Fig. 3-13).

Sections 6 to 11 contain "Data to determine maximum shaft load" sections.

- ⇒ Using those characteristics determine maximum allowed radial force $F_{\text{radial_max}}$ for your application.
- ⇒ Make sure that the radial force determined is not exceeded at any time during operation.

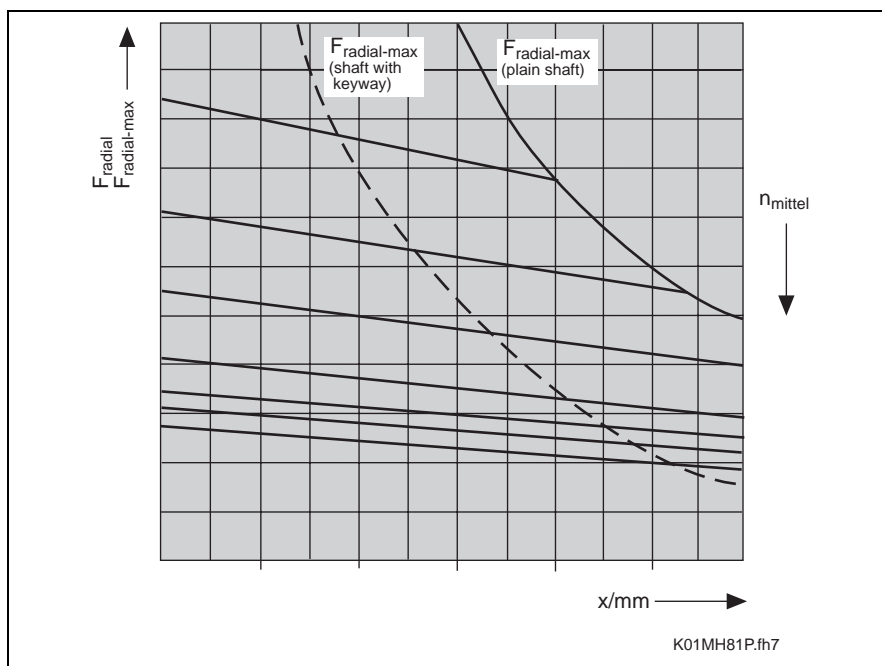

Fig. 3-13: Diagram of an example of maximum allowed axial or radial force

Allowed axial force F_{axial}

It is proportional to the allowed radial force F_{radial} .

The proportionality factor is listed in sections 6 through 11 in section „Data for Determining Maximum Shaft Load “.

⇒ Determine maximum allowed axial force F_{axial} for your application using the information there.

⇒ Make sure that the determined axial force is not exceeded during operation. Also note the following!

Note: Thermal conditions can cause the flange side of the output shaft to shift in contrast to the motor housing by up to 0.6 mm. The use of drive pinions or bevel gear pinions mounted directly to the output shaft means that this change in length could lead to

- a position shifting of the axis if the drive pinions are not axially mounted to the machine
- to a thermally-dependent component of the axial force if the drive pinions are axially mounted to the machine. This means that the maximum allowed axial force could be exceeded or the play within the gear teeth could be increased to unacceptable levels.

It is therefore advisable to use own-supported drive elements connected to the motor shaft with compensating coupling units!

Bearing service life L_{10h} If the allowed radial and axial forces are not exceeded, then it applies to the nominal bearing service lifespan:

$L_{10h} = 30,000$ operating hours (computed per ISO 281, ed. 12/1990).

Lifespan otherwise is derated:

$$L_{10h} = \left(\frac{F_{\text{radial}}}{F_{\text{radial_ist}}} \right)^3 \cdot 30000$$

L_{10h} : bearing lifespan (per ISO 281, ed. 12/1990)

F_{radial} : determined allowed radial force in N

$F_{\text{radial_ist}}$: actual effective radial force in N

Fig. 3-14: Computing bearing lifespan L_{10h} if allowed radial force F_{radial} is exceeded

Note: The actually effective radial force $F_{\text{radial_ist}}$ may not exceed maximum allowed radial force $F_{\text{radial_max}}$.

Mounting drive elements **Note:** When mounting drive elements to an output shaft an overdefined bearing must be avoided. The inevitable tolerances generate additional forces applied to the bearings of the motor shaft and thus to a clearly shorter service life. If such a construction cannot be avoided, then please consult INDRAMAT!

3.7 Surface Cooling

For extreme loads such as continuous start/stop operations with high repetitive frequencies, a radial surface blower can be mounted to MHD093, MHD112 and MHD115 motors.

Blower motors using supply voltages of 1 x AC230 V and 1 x AC115 V are available.

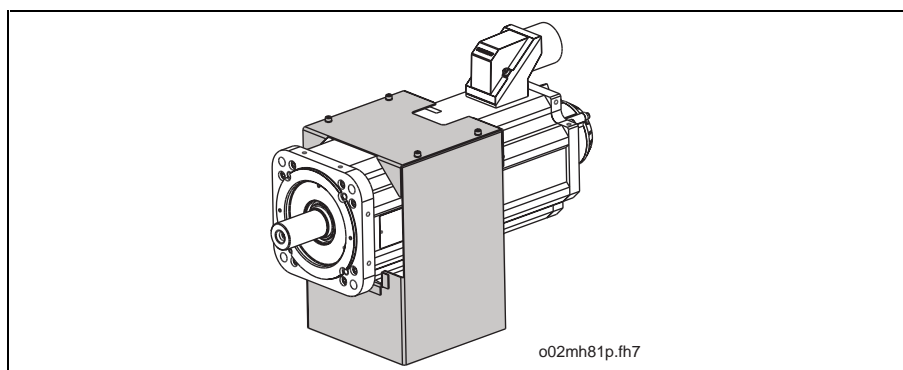

Fig. 3-15: Example of an MHD motor with radial surface cooling

Radial surface cooling is specified as a subitem at the time the motor is ordered in terms of „mounted to motor” and then delivered as such. For more information on ordering, see sections to.

Note: Motors with mounted blower units are not suited for such as applications with shock loads that exist with

- stamping
- pressing or
- gantry axes

In such cases, use motors without surface cooling and higher torques.

3.8 Liquid-Cooled MHD Motors

For extreme loads such as continuous start/stop operations with high repetitive frequencies, motors MHD093.-...-...-N and MHD115.-...-...-N can be operated with liquid cooling.

The figure below illustrates the coolant line connections for motor types MHD093.-...-...-N and MHD115.-...-...-N.

The connections for in and out flow is fitted with a R1/8" thread. For more details and the various connection types, see section "5".

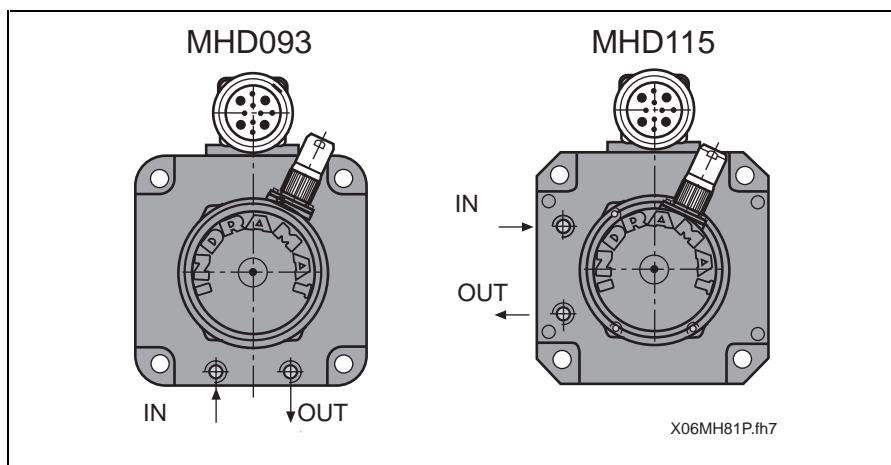

Fig. 3-16: Liquid cooling MHD093 and MHD115

3.9 Holding Brake

Option. To fix servo axes in a voltage-less state of the machine.

The brake works with the „Electrically released“ principle. If no voltage is applied, then a magnetic force fixed the brake disc. This closes the brake and holds the axis.

If 24 VDC are applied then the continuous magnetic field is compensated by the electrically-generated magnetic field and the brake opens.

The drive controller controls the brake. This ensures the correct on and off sequence in all operating states.



Falling axes!

Danger to personnel by pinching or cutting off of body parts.

⇒ Just the holding brake alone does not guarantee personnel safety. Higher-ranking constructive measures such as protective fences and grids or a second brake must also be used.

Note: Premature wear of holding brake is possible!

- The brake wears down after about 20,000 revolutions of the motor in a closed state. Therefore, do not use the holding brake as if it were a normal brake to stop a moving axis. This is only permitted in an emergency stop situation.
-

Holding torque must be checked prior to start up.

Note: If motors have been stored for extended periods, then the transferrable torque of the holding brake must be checked before the motor is used. If the holding torque specified in the data sheets is not reached, then the brake must be re-finished.

⇒ Please note data in section „brake“.

3.10 Output Direction of the Electrical Connections

Power connections As per Fig. 3-17 the output direction of the electrical power connections can be selected.

Connection	Possible output directions
Plug-in connection with turnable housing (MHD041, MHD071 and MHD090)	
Plug-in connector with fixed housing (MHD093, MHD112 and MHD115)	

Fig. 3-17: Possible output directions of the electrical power connections

The output directions with MHD041 MHD071 and MHD090 motors can be set over a range of 270° at mounting. For motors MHD093, MHD112 and MHD115 the output direction is set at the time the order is placed.

Note: The output direction specified at the time of order for MHD093, MHD112 and MHD115 can also be altered at the time of mounting. See section „15.3” for details.

Feedback connections The output direction of the feedback connections for MHD041, MHD071 and MHD090 motors can be set to a range of 270° at mounted or possible restricted by the output direction of the power connection.

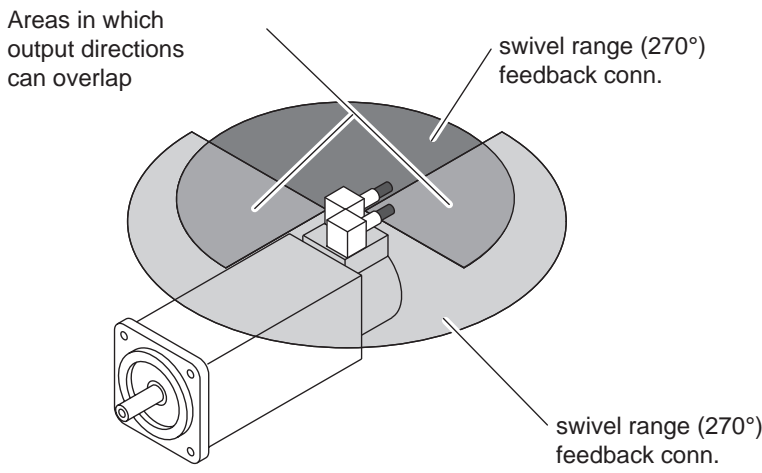
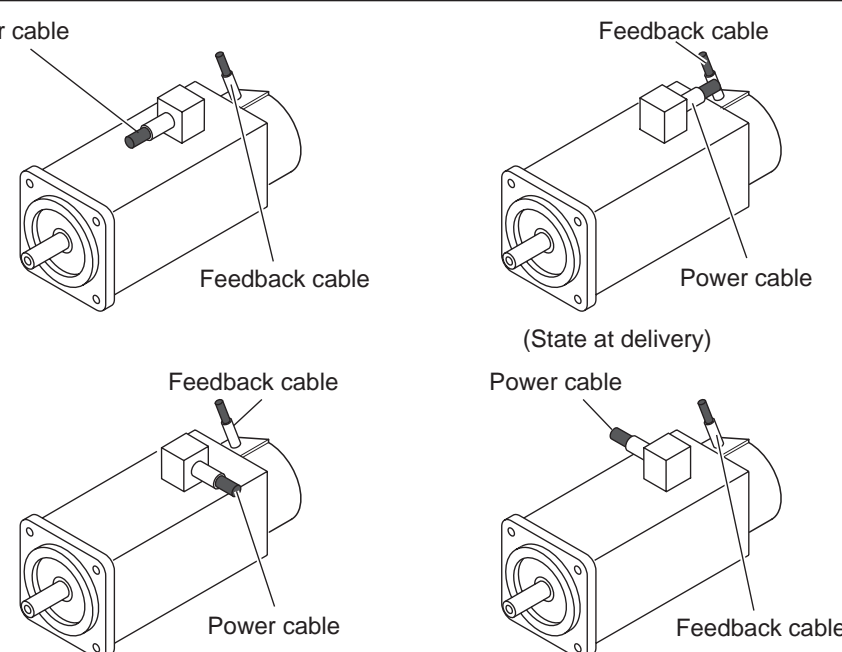
If angle feedback connectors are used with MHD093, MHD112 and MHD115 motors, then the output direction of the feedback cable can only be side B of the motor.

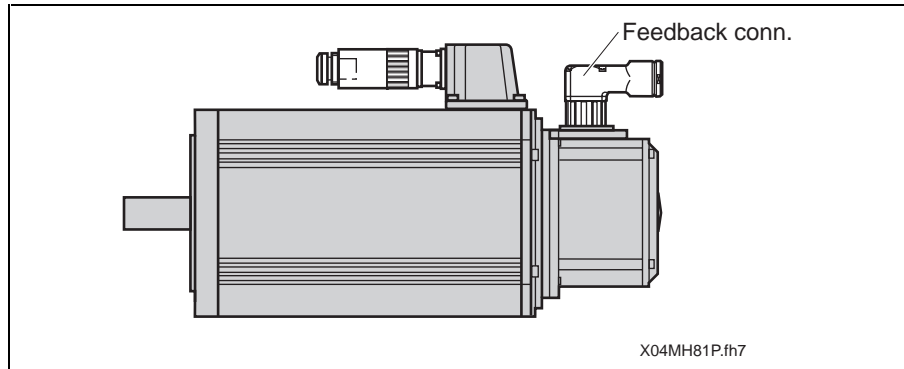

Fig. 3-18: MHD motor with angle feedback connectors

Note: The cable output direction of the angle feedback connector can be changed at mounting. See section 15.3 Feedback Cable .

3.11 Speed/Torque Characteristics

The speed/torque characteristics in Fig.3-19 illustrate

- torque limit data
- speed limit data and
- operating characteristics.

The diagram for each motor can be found in sections 6 to 11, see Speed/Torque characteristics.

⇒ Use this diagram to

- Determine maximum usable speed with known torque requirements.
- Check whether thermal limits of motor are maintained or not. This means that the rms torque achieved with a limit cycle, lies below the S1 continuous operating curve (M_{dN}) with an arithmetically determined speed (arithmetic mean).
- Enter the data listed in the selection list onto your selection record.

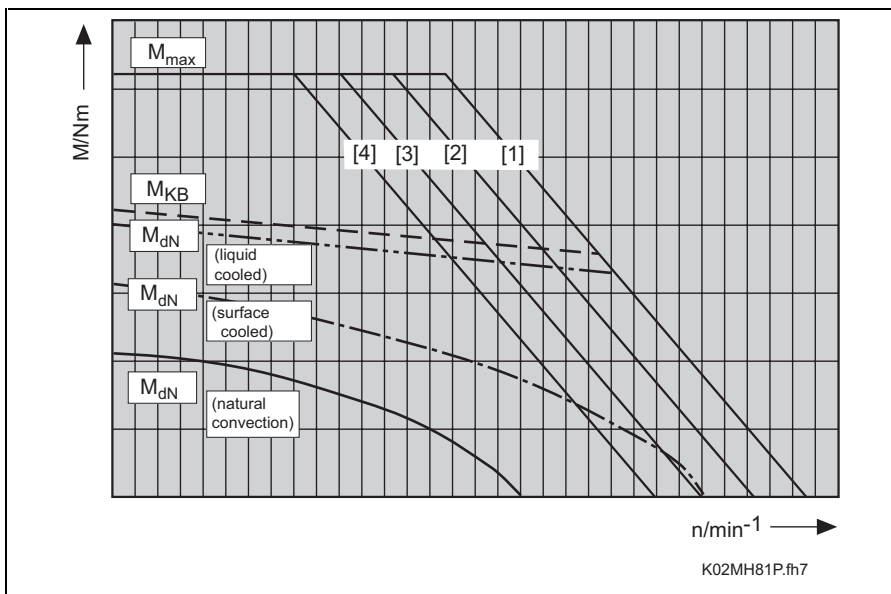

Fig.3-19: Diagram of an example of speed/torque characteristics

M_{max} Equals the theoretically possible maximum torque of the motor. Can be limited by the drive controller.

(M_{dN}) The maximum torque of a **motor/controller combination** always appear in the selection lists.

M_{KB} S6 intermittent curve at 25% ON time of motor (per DIN VDE 0530, ed. 07/1991). Maximum duty cycle time equals 15 minutes.

M_{dN} S1 continuous curve of motor (per DIN VDE 0530, ed. 07/1991).

Characteristics (1) to (4) As of a „knee“ speed maximum achievable usable speed depends on the available torque. As maximum motor speed depends on the DC bus voltage used, the individual controllers have separate curves for each supply unit used and possible even their supply voltage.

- (1) **HDS** or **HDD** on **HVR** power supply unit
- (2) **HDS** or **HDD** on power supply unit **HVE** with a mains connection to **3 x AC 480 V** or **DKCxx.3** with a mains connection to **3 x AC 480V**
- (3) **HDS** or **HDD** on power supply unit **HVE** with a mains connection to **3 x AC 440 V** or **DKCxx.3** with a mains connection to **3 x AC 440V**
- (4) **HDS** or **HDD** on power supply unit **HVE** with a mains connection to **3 x AC 400 V** or **DKCxx.3** with a mains connection to **3 x AC 400V**

Note: The curves (2-4) specified in sec. 6 to 11 are „worst case“ scenarios. The curves contain possible mains undervoltages and production tolerances.

4 Electrical Connections

4.1 An Overview of the Connections

The electrical connections of an INDRAMAT drive have been standardized. There are on an MHD AC motor:

- a power connection including connections for temperature sensors and holding brakes
- and a feedback connection.

Both connections are separate plug-in connections. For more details about the output directions, see section 3.10 .

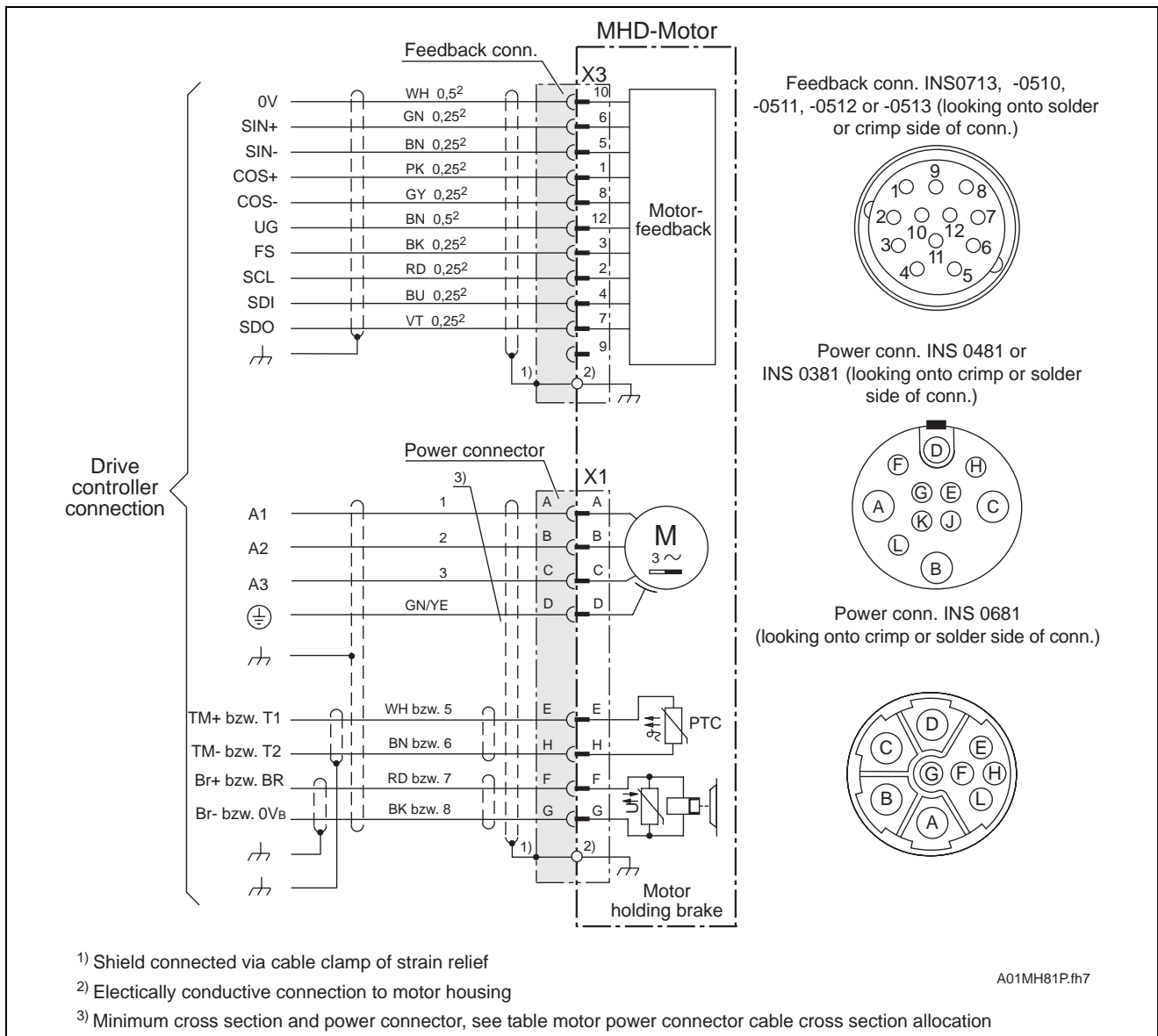

Fig. 4-1: Connection plans for MHD motors

For motors with surface cooling please use your own cables to connect the motor blower. For details on connecting and mounting the blower connector, see section 15.4 .

4.2 Power Cables

MHD motors are preferably equipped with standard power cables.

These power cables are available in the following versions:

- direct connections
- connections with intermediate plug-in locations

⇒ The following table lists the cable designations, i.e., order designations, or the motor/controller combinations.

Lengths Available cable lengths are 2 to 75 meters.

⇒ To order, simply state the cable length(s) needed. Example: IKG4009 / 10.5 (=power cable for DKCxx.3, length 10.5m).

Note: The maximum total length of the cable connection from motor to drive controller with two intermediate plugs equals 75 meters. With several plug-in locations the maximum total length is reduced. This, however, should be checked to see whether it is functioning properly or not.

Motor	Cooling	Terminal strip	DKCxx.3 40/100A	DKCxx.3 200A	HDD02.x HDS02.x 40A	HDS03.x HDS04.x
MHD						
INS0681						
041A-144	natural convection	IKG4008	IKG4009	---	IKG4017	IKG4077
041B-144	natural convection	IKG4008	IKG4009	---	IKG4017	IKG4077
071A-035	natural convection	IKG4008	IKG4009	---	IKG4017	IKG4077
071B-035	natural convection	IKG4008	IKG4009	---	IKG4017	IKG4077
071B-035	surface cooling	IKG4008	IKG4009	---	IKG4017	IKG4077
071B-061	natural convection	IKG4008	IKG4009	---	IKG4017	IKG4077
071B-061	surface cooling	IKG4008	IKG4009	---	IKG4017	IKG4077
090B-035	natural convection	IKG4008	IKG4009	---	IKG4017	IKG4077
090B-035	surface cooling	IKG4008	IKG4009	---	IKG4017	IKG4077
090B-047	natural convection	IKG4008	IKG4009	---	IKG4017	IKG4077
090B-047	surface cooling	IKG4029	IKG4039	---	IKG4028	IKG4077
090B-058	natural convection	IKG4008	IKG4009	---	IKG4017	IKG4077
090B-058	surface cooling	IKG4073	IKG4071	---	IKG4072	IKG4077

cabl0681.d.fh7

Fig. 4-2: Motor power cable for „direct connection“ (Table 1)





Motor	Cooling	Terminal strip	DKCxx.3 40/100A	DKCxx.3 200A	HDD02.x HDS02.x 40A	HDS03.x HDS04.x
MHD INS0481						
093A-024	natural convection	IKG4053	IKG4060	---	IKG4055	IKG4047
093A-035	natural convection	IKG4053	IKG4060	---	IKG4055	IKG4047
093A-058	natural convection	IKG4053	IKG4060	---	IKG4055	IKG4047
093B-035	natural convection	IKG4053	IKG4060	---	IKG4055	IKG4047
093B-035	surface cooling	IKG4053	IKG4060	---	IKG4055	IKG4047
093B-035	liquid cooling	IKG4063	IKG4070	---	IKG4068	IKG4067
093B-058	natural convection	IKG4053	IKG4060	---	IKG4055	IKG4047
093B-058	surface cooling	IKG4083	IKG4090	---	---	IKG4087
093B-058	liquid cooling	IKG4083	IKG4090	---	---	IKG4087
093C-035	natural convection	IKG4053	IKG4060	---	IKG4055	IKG4047
093C-035	surface cooling	IKG4063	IKG4070	---	IKG4068	IKG4067
093C-035	liquid cooling	IKG4083	IKG4090	---	---	IKG4087
093C-058	natural convection	IKG4063	IKG4070	---	IKG4068	IKG4067
093C-058	surface cooling	IKG4083	IKG4090	---	---	IKG4087
093C-058	liquid cooling	IKG4103	IKG4110	IKG4110	---	IKG4107
112A-024	natural convection	IKG4053	IKG4060	---	IKG4055	IKG4047
112A-058	natural convection	IKG4053	IKG4060	---	IKG4055	IKG4047
112B-024	natural convection	IKG4053	IKG4060	---	IKG4055	IKG4047
112B-024	surface cooling	IKG4083	IKG4090	---	---	IKG4087

Fig. 4-3: Motor power cable for „direct connection“ (Table 2)



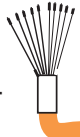
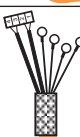





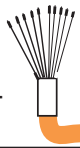
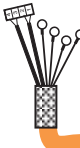

Cooling		Direct connection to ECODRIVE03/ DIAX04					
Motor		Terminal strip	DKCxx.3 40/100A	DKCxx.3 200A	HDD02.x HDS02.x 40A	HDS03.x HDS04.x	
MHD	INS0481						
112B-048	natural convection	IKG4083	IKG4090	---	---	IKG4087	
112B-048	surface cooling	IKG4103	IKG4110	IKG4110	---	IKG4107	
112B-058	natural convection	IKG4083	IKG4090	---	---	IKG4087	
112B-058	surface cooling	IKG4123	IKG4130	IKG4130	---	IKG4127	
112C-024	natural convection	IKG4063	IKG4070	---	IKG4068	IKG4067	
112C-024	surface cooling	IKG4083	IKG4090	---	---	IKG4087	
112C-035	natural convection	IKG4063	IKG4070	---	IKG4068	IKG4067	
112C-035	surface cooling	IKG4103	IKG4110	---	---	IKG4107	
112D-027	natural convection	IKG4063	IKG4070	---	IKG4068	IKG4067	
112D-027	surface cooling	IKG4083	IKG4090	---	---	IKG4087	
							2_cable0481d.fh7

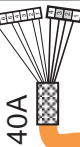
Fig. 4-4: Motor power cable for „direct connection“ (Table 3)

Motor	Cooling	terminal strip	DKCxx.3 40/100A	DKCxx.3 200A	HDD02.x HDS02.x 40A	HDS03.x HDS04.x
MHD						
						
112C-058	natural convection	IKG4143	IKG4150	IKG4150	---	IKG4147
112C-058	surface cooling	IKG4183	---	IKG4200	---	IKG4186
115A-024	natural convection	IKG4143	IKG4150	IKG4150	---	IKG4147
115A-024	liquid cooling	IKG4143	IKG4150	IKG4150	---	IKG4147
115A-058	natural convection	IKG4143	IKG4150	IKG4150	---	IKG4147
115A-058	liquid cooling	IKG4163	IKG4170	IKG4170	---	IKG4167
115B-024	natural convection	IKG4143	IKG4150	IKG4150	---	IKG4147
115B-024	surface cooling	IKG4143	IKG4150	IKG4150	---	IKG4147
115B-024	liquid cooling	IKG4143	IKG4150	IKG4150	---	IKG4147
115B-058	natural convection	IKG4163	IKG4170	IKG4170	---	IKG4167
115B-058	surface cooling	IKG4183	---	IKG4200	---	IKG4186
115B-058	liquid cooling	IKG4203	IKG4210	IKG4210	---	IKG4204
115C-024	natural convection	IKG4143	IKG4150	IKG4150	---	IKG4147
115C-024	surface cooling	IKG4163	IKG4170	IKG4170	---	IKG4167
115C-024	liquid cooling	IKG4183	---	IKG4200	---	IKG4186
115C-058	natural convection	IKG4183	---	IKG4200	---	IKG4186
115C-058	surface cooling	IKG4203	---	IKG4210	---	IKG4204
115C-058	liquid cooling	IKG4223	---	---	---	IKG4224

1_cable0381d.fh7

Fig. 4-5: Motor power cable for „direct connection“ (Table 4)

Motor	Cooling			Terminal strip	DKCxx.3 40/100A	DKCxx.3 200A	HDD/HDS 40A	HDS03 HDS04	
MHD INS0681									
Connection with intermediate point for ECODRIVE / DIAx04									
041A-144	natural Convection	IKG4006	IKG4008	IKG4009	---	IKG4017	IKG4077	IKG4077	
041B-144	natural Convection	IKG4006	IKG4008	IKG4009	---	IKG4017	IKG4077	IKG4077	
071A-035	natural Convection	IKG4006	IKG4008	IKG4009	---	IKG4017	IKG4077	IKG4077	
071B-035	natural Convection	IKG4006	IKG4008	IKG4009	---	IKG4017	IKG4077	IKG4077	
071B-035	surface cooling	IKG4006	IKG4008	IKG4009	---	IKG4017	IKG4077	IKG4077	
071B-061	natural Convection	IKG4006	IKG4008	IKG4009	---	IKG4017	IKG4077	IKG4077	
071B-061	surface cooling	IKG4006	IKG4008	IKG4009	---	IKG4017	IKG4077	IKG4077	
090B-035	natural Convection	IKG4006	IKG4008	IKG4009	---	IKG4017	IKG4077	IKG4077	
090B-035	surface cooling	IKG4006	IKG4008	IKG4009	---	IKG4017	IKG4077	IKG4077	
090B-047	natural Convection	IKG4006	IKG4008	IKG4009	---	IKG4017	IKG4077	IKG4077	
090B-047	surface cooling	IKG4027	IKG4029	IKG4039	---	IKG4028	IKG4077	IKG4077	
090B-058	natural Convection	IKG4006	IKG4008	IKG4009	---	IKG4017	IKG4077	IKG4077	
090B-058	surface cooling	IKG4074	IKG4073	IKG4071	---	IKG4072	IKG4077	IKG4077	
<div style="display: flex; justify-content: center; align-items: center;"> <div style="margin-right: 20px;">Option</div> </div>									
cable0681z.fh7									

Fig. 4-6: Motor power cable „ with intermediate point“ (Table 1)

Motor	Cooling	Terminal strip	DKCxx.3 40/100A	DKCxx.3 200A	HDD02.x HDS02.x 40A	HDS03.x HDS04.x	
MHD INS0481							
093A-024	natural convection	IKG4053	IKG4060	---	IKG4055	IKG4047	
093A-035	natural convection	IKG4053	IKG4060	---	IKG4055	IKG4047	
093A-058	natural convection	IKG4053	IKG4060	---	IKG4055	IKG4047	
093B-035	natural convection	IKG4053	IKG4060	---	IKG4055	IKG4047	
093B-035	surface cooling	IKG4053	IKG4060	---	IKG4055	IKG4047	
093B-035	liquid cooling	IKG4063	IKG4070	---	IKG4068	IKG4067	
093B-058	natural convection	IKG4053	IKG4060	---	IKG4055	IKG4047	
093B-058	surface cooling	IKG4083	IKG4090	---	---	IKG4087	
093B-058	liquid cooling	IKG4083	IKG4090	---	---	IKG4087	
093C-035	natural convection	IKG4053	IKG4060	---	IKG4055	IKG4047	
093C-035	surface cooling	IKG4063	IKG4070	---	IKG4068	IKG4067	
093C-035	liquid cooling	IKG4083	IKG4090	---	---	IKG4087	
093C-058	natural convection	IKG4063	IKG4070	---	IKG4068	IKG4067	
093C-058	surface cooling	IKG4083	IKG4090	---	---	IKG4087	
093C-058	liquid cooling	IKG4103	IKG4110	IKG4110	---	IKG4107	
		Option Flange socket INS0483/xxx					





1_cable0481z.ih7

Fig. 4-7: Motor power cable „with intermediate point“ (Table 2)

Motor	Cooling	INS0481	Terminal strip	DKCxx.3 40/100A	DKCxx.3 200A	HDD02.x HDS02.x 40A	HDS03.x HDS04.x
112A-024	natural convection	IKG4052 C02	IKG4053	IKG4060	---	IKG4055	IKG4047
112A-058	natural convection	IKG4052 C02	IKG4053	IKG4060	---	IKG4055	IKG4047
112B-024	natural convection	IKG4052 C02	IKG4053	IKG4060	---	IKG4055	IKG4047
112B-024	surface cooling	IKG4082 C04	IKG4083	IKG4090	---	---	IKG4087
112B-048	natural convection	IKG4082 C04	IKG4083	IKG4090	---	---	IKG4087
112B-048	surface cooling	IKG4102 C06	IKG4103	IKG4110	IKG4110	---	IKG4107
112B-058	natural convection	IKG4082 C04	IKG4083	IKG4090	---	---	IKG4087
112B-058	surface cooling	IKG4122 C04	IKG4123	IKG4130	IKG4130	---	IKG4127
112C-024	natural convection	IKG4062 C03	IKG4063	IKG4070	---	IKG4068	IKG4067
112C-024	surface cooling	IKG4082 C04	IKG4083	IKG4090	---	---	IKG4087
112C-035	natural convection	IKG4062 C03	IKG4063	IKG4070	---	IKG4068	IKG4067
112C-035	surface cooling	IKG4102 C06	IKG4103	IKG4110	---	---	IKG4107
112D-027	natural convection	IKG4062 C03	IKG4063	IKG4070	---	IKG4068	IKG4067
112D-027	surface cooling	IKG4102 C06	IKG4103	IKG4110	IKG4110	---	IKG4107
Option Flange socket INS0483/xxx							

2_cable0481z.fh7

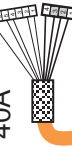
Fig. 4-8: Motor power cable „ with intermediate point“ (Table 3)

Motor	Cooling					
MHD						
INS0381						
112C-058	natural convection	IKG4141	IKG4150	IKG4150	---	IKG4147
112C-058	surface cooling	IKG4181	---	IKG4200	---	IKG4186
115A-024	natural convection	IKG4141	IKG4150	IKG4150	---	IKG4147
115A-024	liquid cooling	IKG4141	IKG4150	IKG4150	---	IKG4147
115A-058	natural convection	IKG4141	IKG4150	IKG4150	---	IKG4147
115A-058	liquid cooling	IKG4161	IKG4170	IKG4170	---	IKG4167
115B-024	natural convection	IKG4141	IKG4150	IKG4150	---	IKG4147
115B-024	surface cooling	IKG4141	IKG4150	IKG4150	---	IKG4147
115B-024	liquid cooling	IKG4141	IKG4150	IKG4150	---	IKG4147
115B-058	natural convection	IKG4161	IKG4170	IKG4170	---	IKG4167
115B-058	surface cooling	IKG4181	---	IKG4200	---	IKG4186
115B-058	liquid cooling	IKG4201	IKG4210	IKG4210	---	IKG4204
115C-024	natural convection	IKG4141	IKG4150	IKG4150	---	IKG4147
115C-024	surface cooling	IKG4161	IKG4170	IKG4170	---	IKG4167
115C-024	liquid cooling	IKG4181	---	IKG4200	---	IKG4186
115C-058	natural convection	IKG4181	---	IKG4200	---	IKG4186
		 Option Flange socket INS0383/xxx				

1_cable0381.fh7

Fig. 4-9: Motor power cable „with intermediate point“ (Table 4)

4.3 Feedback Cables

MHD motors are preferably equipped with standard feedback cables.

These feedback cables are, as is the case with the power cables, for „direct connection“ and „Connections with intermediate plug-in locations“ and are available in the following versions:

- „straight“ or
- „angled“

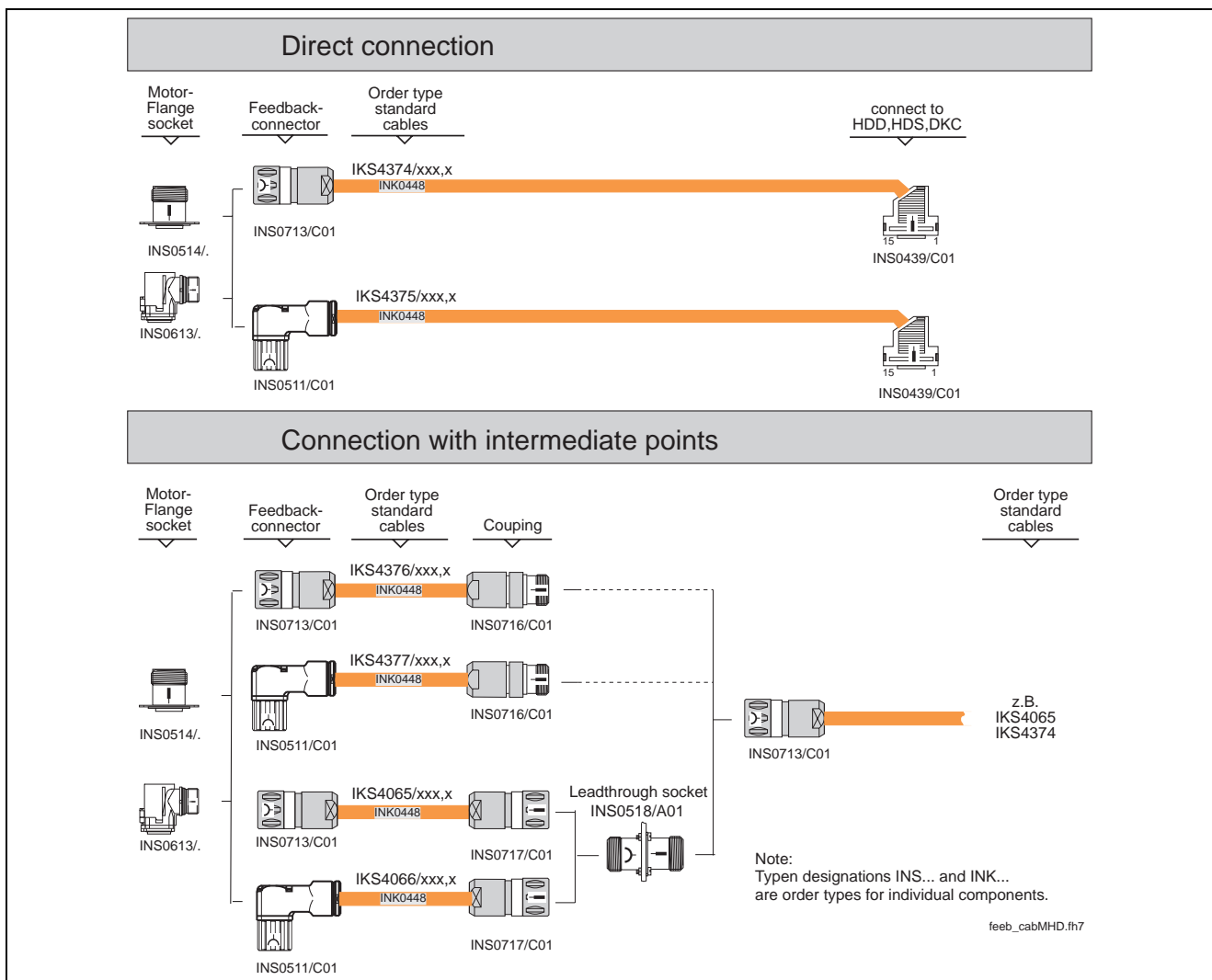

Fig. 4-11: Standard feedback cables

⇒ In Fig. 4-11 select that cable or that combination of two cables that suit your motor/controller combination.

Lengths Available lengths: **any** in 0.5m increments up to a maximum of 75 meters.

⇒ To order, simply specify cable type and desired length. Example: IKS4374 / 5.5 (= feedback cables, length 5.5m).

Note: The maximum total length of the cable connection from motor to drive controller with two intermediate plugs equals 75 meters. With several plug-in locations the maximum total length is reduced. This, however, must then be tested to see whether it is functional or not.

4.4 Technical Data of Power and Feedback Cables

Name	Unit	Data									
		IKG	IKG	IKG	IKG	IKG	IKG	IKG	IKG	IKG	IKS
Type designations of the standard cables IKG... or IKS...		4006 4007 4008 4009	4047 4051 4052 4053 4055 4060	4061 4062 4063 4067 4068 4070	4081 4082 4083 4087 4090	4101 4102 4103 4107 4110 4141 4142 4143 4147 4150	4121 4122 4123 4127 4130 4161 4162 4163 4167 4170	4181 4182 4183 4186	4201 4202 4203 4204	4221 4222 4223 4224	4374 4375 4376 4377
Type designations cable (non-standard) INK...		0653	0650	0602	0603	0604	0605	0606	0607	0667	0448
Power or supply cross sections	mm ²	4 x 1.0	4 x 1.5	4 x 2.5	4 x 4.0	4 x 6.0	4 x 10.0	4 x 16.0	4 x 25.0	4 x 35.0	2 x 0.5
Control cross sections (holding brake, temperature monitoring or control voltage)	mm ²	2 x (2 x 0.75)	2 x (2 x 0.75)	2 x (2 x 1.0)	(2 x 1.0) + (2 x 1.5)	(2 x 1.0) + (2 x 1.5)	(2 x 1.0) + (2 x 1.5)	2 x (2 x 1.5)	2 x (2 x 1.5)	2 x (2 x 1.5)	4 x (2 x 0.25)
Diameter	mm	12.0 ±0.5	12.2 ±0.5	15.0 ±0.8	17.8 ±0.6	18.6 ±0.8	22.5 ±1.0	27.6 ±0.8	30.4 ±0.8	32.4 ±0.9	8.8 ±0.3
Minimum bend radius with fixed routing with flexible routing (≥2 000 000 bend loads)	mm mm	75 120	85 140	95 160	100 180	140 190	170 230	190 280	210 300	230 320	45 90
Spec. cable weight	kg/m	0.22	0.24	0.33	0.49	0.59	0.87	1.31	1.72	2.16	0.11
Protection category with correct mounting of plug-in connections		IP 65									
Chemical features		absolute resistance to mineral oils and greases, hydrolysis resistant, silicone and halogen free									
Allowed ambient temperature for storage	°C	-30 to +80									
Allowed ambient temperature for operation	°C	-30 to +40									
Cable surface		poor adhesion, prevents slipping in drag chains									

Fig. 4-12: Technical data of power and feedback cables for MHD motors

4.5 Individual Parts

Note: The user can make INDRAMAT cables himself. The parts needed for this are listed in the document „Connection accessories for INDRAMAT drives”, doc. no. 209-0050-4399-XX. If INDRAMAT cables are not used, it is still necessary to use INDRAMAT connectors. When selecting the plug-in connections note cable cross sections.

Note: Guarantee forfeited!

- If **non-INDRAMAT** cables are used, then the guarantee for the entire system is forfeited, e.g., EMC guidelines and similar. It is recommended and advisable to use INDRAMAT cables only!
-

Selecting power connectors and cables

- ⇒ Use the following list to determine which motor power connector and cable cross sections are needed for individual MHD motors.
- ⇒ Motor power connections are available in crimped or soldered versions.
- ⇒ With motor power connectors, there must be strain reliefs that match the conduit threads in the cables used. The dimensions of the relevant conduit thread connectors are listed in sections 6 through 11, section „Dimensions“.

Motor	Cooling	Motor phase current	Minimum cross section of power connection ¹⁾				Power connector					
			INDRAMAT cables		Standard PVC cables		Crimping		Soldering			
			mm ²	mm ²	mm ²	AWG ³⁾	INDRAMAT cables	Standard PVC cables	INS...	INS...		
MHD...		A										
041A-144	natural convection	2,5	1	1	18	0681/C03	0681/C03	0681/C03	---			
041B-144	natural convection	5,3	1	1	18	0681/C03	0681/C03	0681/C03	---			
071A-061	natural convection	3,7	1	1	18	0681/C03	0681/C03	0681/C03	---			
071B-035	natural convection	4,5	1	1	18	0681/C03	0681/C03	0681/C03	---			
071B-035	surface cooling	6,7	1	1	18	0681/C03	0681/C03	0681/C03	---			
071B-061	natural convection	7,9	1	1	18	0681/C03	0681/C03	0681/C03	---			
071B-061	surface cooling	11,9	1	1,5	16	0681/C03	0681/C03	0681/C03	---			
090B-035	natural convection	7,8	1	1	18	0681/C03	0681/C03	0681/C03	---			
090B-035	surface cooling	11,7	1	1,5	16	0681/C03	0681/C03	0681/C03	---			
090B-047	natural convection	9,3	1	1	18	0681/C03	0681/C03	0681/C03	---			
090B-047	surface cooling	14,0	1,5	2,5	14	0681/C03	0681/C03	0681/C03	---			
090B-058	natural convection	12,4	1	1,5	16	0681/C03	0681/C03	0681/C03	---			
090B-058	surface cooling	18,6	2,5	4	12	0681/C03	0681/C03	0681/C03	---			
093A-024	natural convection	5,4	1,5 ²⁾	1,5 ²⁾	16	0481/C02	0481/C02	0481/C02	0481/L10			
093A-035	natural convection	7,4	1,5 ²⁾	1,5 ²⁾	16	0481/C02	0481/C02	0481/C02	0481/L10			
093A-058	natural convection	9,1	1,5 ²⁾	1,5 ²⁾	16	0481/C02	0481/C02	0481/C02	0481/L10			
093B-035	natural convection	9,1	1,5 ²⁾	1,5 ²⁾	18	0481/C02	0481/C02	0481/C02	0481/L10			
093B-035	surface cooling	13,6	1,5 ²⁾	2,5	14	0481/C02	0481/C02	0481/C03	0481/L10			
093B-035	liquid cooling	17,2	2,5	4	12	0481/C03	0481/C03	0481/C04	0481/L10			
093B-058	natural convection	15,9	1,5	2,5	14	0481/C02	0481/C02	0481/C03	0481/L10			
093B-058	surface cooling	23,9	4	6	10	0481/C04	0481/C04	0481/C06	0481/L10			
093B-058	liquid cooling	30,3	4	10	8	0481/C04	---	---	0481/L10			
093C-035	natural convection	13,1	1,5	2,5	14	0481/C02	0481/C02	0481/C03	0481/L10			
093C-035	surface cooling	19,7	2,5	4	12	0481/C03	0481/C03	0481/C04	0481/L10			
093C-035	liquid cooling	24,9	4	6	10	0481/C04	0481/C04	0481/C06	0481/L10			

Continued on next pag

Fig. 4-13: Motor power connector and cable cross sections

Motor	Cooling	Motor phase current	Minimum cross section of power connection ¹⁾				Power connector		
			INDRAMAT cables		Standard PVC cables		Crimping		
			mm ²	mm ²	mm ²	AWG ³⁾	INDRAMAT cables	Standard PVC cables	Soldering
MHD...		A					INS...	INS...	INS...
093C-058	natural convection	20,0	2,5	4	12	0481/C03	0481/C04	0481/L10	0481/L10
093C-058	surface cooling	30,1	4	10	8	0481/C04	---	0481/L10	0481/L10
093C-058	liquid cooling	38,0	6	10	8	0481/C06	---	0481/L10	0481/L10
112A-024	natural convection	9,3	1,5 ²⁾	1,5 ²⁾	16	0481/C02	0481/C02	0481/L10	0481/L10
112A-058	natural convection	12,1	1,5 ²⁾	1,5 ²⁾	16	0481/C02	0481/C02	0481/L10	0481/L10
112B-024	natural convection	15,5	1,5	2,5	14	0481/C02	0481/C03	0481/L10	0481/L10
112B-024	surface cooling	23,3	4	6	10	0481/C04	0481/C06	0481/L10	0481/L10
112B-048	natural convection	25,2	4	6	10	0481/C04	0481/C06	0481/L10	0481/L10
112B-048	surface cooling	37,8	6	10	8	0481/C06	---	0481/L10	0481/L10
112B-058	natural convection	28,8	4	6	10	0481/C04	0481/C06	0481/L10	0481/L10
112B-058	surface cooling	43,2	10	---	---	---	---	0481/L10	0481/L10
112C-024	natural convection	18,8	2,5	4	12	0481/C03	0481/C04	0481/L10	0481/L10
112C-024	surface cooling	28,2	4	6	10	0481/C04	0481/C06	0481/L10	0481/L10
112C-035	natural convection	21,9	2,5	4	12	0481/C03	0481/C04	0481/L10	0481/L10
112C-035	surface cooling	32,9	6	10	8	0481/C06	---	0481/L10	0481/L10
112C-058	natural convection	37,6	6	10	8	0381/C06	0381/C10	0381/L35	0381/L35
112C-058	surface cooling	56,4	16	25	4	0381/C06	0381/C25	0381/L35	0381/L35
112D-027	natural convection	22,3	2,5	4	12	0481/C03	0481/C04	0481/L10	0481/L10
112D-027	surface cooling	33,5	6	10	8	0481/C06	---	0481/L10	0481/L10
115A-024	natural convection	14,8	6 ³⁾	6	10	0381/C06	0381/C06	0381/L35	0381/L35
115A-024	liquid cooling	28,2	6 ³⁾	6	10	0381/C06	0381/C06	0381/L35	0381/L35
115A-058	natural convection	27,6	6 ³⁾	6	10	0381/C06	0381/C06	0381/L35	0381/L35
115A-058	liquid cooling	52,4	10,0	16	6	0381/C10	0381/C16	0381/L35	0381/L35
115B-024	natural convection	22,8	6 ³⁾	6 ³⁾	10	0381/C06	0381/C06	0381/L35	0381/L35
115B-024	surface cooling	34,3	6	10	8	0381/C06	0381/C10	0381/L35	0381/L35
115B-024	liquid cooling	43,4	10	10	8	0381/C10	0381/C10	0381/L35	0381/L35

Continued on next page

Fig. 4-14: Motor power connector and cable cross sections

Motor	Cooling	Motor phase current	Minimum cross section of power connection ¹⁾				Power connector						
			INDRAMAT cables		Standard PVC cables		Crimping		Soldering				
			mm ²	mm ²	mm ²	AWG ³⁾	INDRAMAT cables	Standard PVC cables	INDRAMAT cables	Standard PVC cables			
					mm ²		INS...		INS...		INS...		
MHD...		A											
115B-058	natural convection	44,2	10	16	6	0381/C10	0381/C16	0381/L35					
115B-058	surface cooling	66,3	16	25	4	0381/C16	0381/C25	0381/L35					
115B-058	liquid cooling	84,0	25	---	---	0381/C25	---	0381/L35					
115C-024	natural convection	33,6	6	10	8	0381/C06	0381/C10	0381/L35					
115C-024	surface cooling	50,4	10	16	6	0381/C10	0381/C16	0381/L35					
115C-024	liquid cooling	63,9	16	25	4	0381/C16	0381/C25	0381/L35					
115C-058	natural convection	58,3	16	25	4	0381/C16	0381/C25	0381/L35					
115C-058	surface cooling	87,5	25	---	---	0381/C25	---	0381/L35					
115C-058	liquid cooling	110,9	35	---	---	---	---	0381/L35					

1) Minimum cross section of power connection as per EN 60204 sec. 1, table 5, col. B2 ed. 1992 or UL 508 table 50.2 ed. 1989 at max. 40°C ambient temp.

2) Only cables with motor power connectors per UL 508 can be soldered.

3) Smallest connection cross section (crimp contacts) to connector sizes INS0480, -0481, -0483 is 1,5 mm².

4) Smallest connection cross section (crimp contacts) to connector sizes INS0380, -0381, -0383 is 6 mm².

Fig. 4-15: Motor power connector and cable cross sections

Feedback connectors ⇒ Use the following list to select that feedback connector suited for your application. Feedback connectors are available crimped or soldered.

Note: Use those feedback connectors for INDRAMAT cables that have a plastic sheathing and integrated cable clamp. Suitable for INDRAMAT cable INK0448 (preferred type) and INK0209. These feedback connectors have been optimized to work with INDRAMAT cables and meet EMC requirements.

If **non-INDRAMAT** cables are used, then use metal feedback connectors with conduit threads (clamping range for cable diameter is 6 to 10 mm).

Name	Feedback connectors for INDRAMAT cables INK0448 or INK0209		Feedback connectors for non-INDRAMAT cables with outside diameters of 6 to 10 mm	
	Crimped type	Soldered type	Crimped type	Soldered type
Connector (straight)	INS0713/C ¹⁾	INS0713/L ¹⁾	---	INS0512/L
Angled connector	INS0511/C	INS0511/L	INS0510/C	INS0510/L

1) Feedback connectors with plastic sheathing.

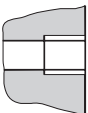
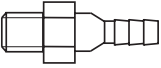

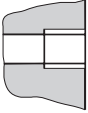
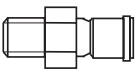
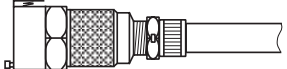

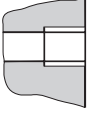
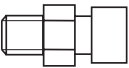

Fig. 4-16: Feedback connectors

Note: Feedback connectors of an angle connector type can be adapted to the conditions of the machine or their output directions at the time of mounting. For details, see section „15.3 Feedback Cable “.

5 Connections for Liquid-Cooling

5.1 Types of Connections

Liquid-cooled motors can have various types of liquid connection options:

Connection	Drawing			
Hose handle	Motor 	Hose handle with thread R1/8" 	Hose 	Hose clip 
Quick coupling	Motor 	Coupling unit with thread R1/8" 	Coupling with clamping screw 	Hose 
Clamp connection	Motor 	Clamp connection with thread R1/8" 	Hose 	

Y03MH81P.ft7

Fig. 5-1: Possible types of connections for liquid cooling

At present, the parts needed for this type of connection are not available from INDRAMAT. Help on selecting and sizing a heat-dissipation device can be found in the document: DOK-DIAX01-DRIVE***LIQ-AUS1-EN-P. It lists order information on the accessories for liquid cooling and names manufacturers and suppliers with addresses for cooling system components.

5.2 Connection Instructions

Coolant lines Coolant lines are available as either

- pipe lines or as
- hose/ duct systems.

Note: Due to the points of deviation, which unavoidably occur in pipeline systems (e.g., a 90° knee), there is considerable loss of pressure in the lines. We thus recommend hose/duct systems.

When selecting cooling lines, please take the pressure drop within the system into account. With greater lengths, the inside diameter of the lines should equal at least 9 mm and grow narrower when reaching the point of connection at the motor.

Coolant The data listed in the document relate to the coolant water.

Pressure drop The coolant flow in the drive component is subject to the cross section of the lines and any directional changes. This means that friction and deviation losses occur. These losses are articulated in the form of a pressure drop Δp .

Pressure drop Δp_n of liquid-cooled motors is specified in the technical data. It references the specified amount of flowthrough of the coolant water. If the flowthrough amount is computed with a different increase in temperature, then the resulting pressure drop is illustrated in the following characteristic curve.

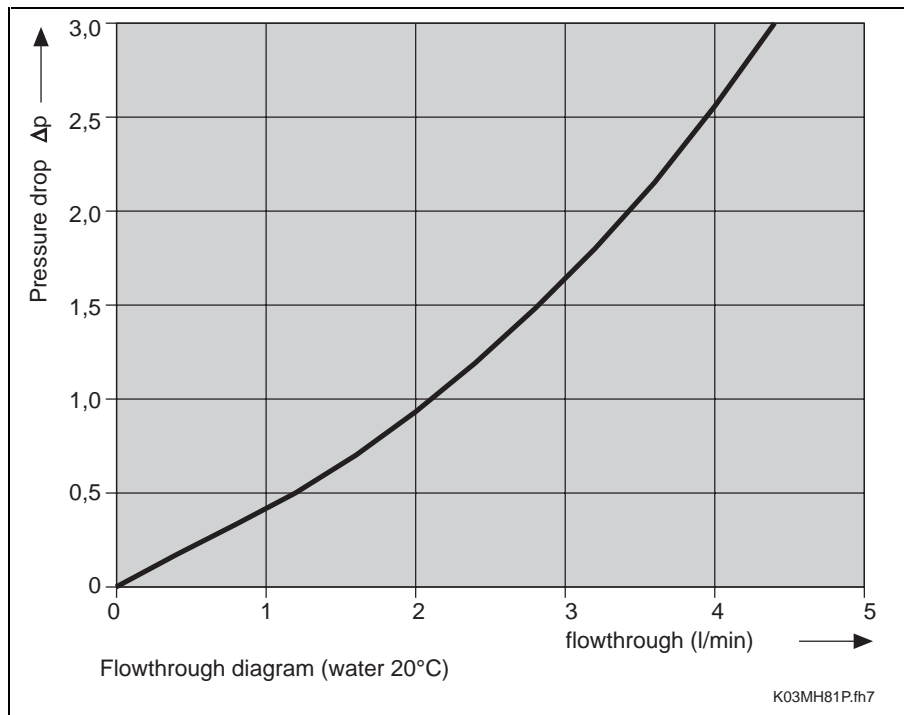

Fig. 5-2: Flowthrough diagram for MHD motors

Note: If a different coolant is used then a different coolant-specified flowthrough diagram applies.

Supplementary documentation Supplementary information on additional substances or other coolants can be found in the document „Liquid cooling of INDRAMAT Drive Components“ (DOK-DIAX01-DRIVE***LIQ-AUS1-EN-P), material number 265 836.

6 MHD041

6.1 Technical Data

Designation	Symbol	Unit	Data	
Motor type			MHD041A-144	MHD041B-144
Rated motor speed ¹⁾	n	min ⁻¹	7500	6000
Continuous torque at standstill ²⁾				
Cooling Natural convection method	M _{dN}	Nm	1.3	2.7
Continuous current at standstill				
Cooling Natural convection method	I _{dN}	A	3.5	7.5
Theoretical maximum torque ³⁾	M _{max}	Nm	5.6	11.3
Peak current	I _{max}	A	15.8	34.4
Rotor moment of inertia ⁴⁾	J _M	kgm ²	0.88 x 10 ⁻⁴	1.7 x 10 ⁻⁴
Torque constant at 20°C	K _m	Nm/A	0.42	0.40
Voltage constant at 20°C ⁵⁾	K _{Eff}	V/1000 min ⁻¹	38.2	36.3
Winding resistance at 20°C	R _A	Ohm	7.0	1.8
Winding inductance	L _A	mH	13.5	5.0
Thermal time constant	T _{th}	min	20	30
Mass ⁴⁾	m _M	kg	2.9	4.5
Allowed ambient temperature ⁶⁾	T _{um}	°C	0 to +45	
Allowed storage and transport temperatures	T _L	°C	-20 to +80	
Maximum installation elevation ⁷⁾		m	1000 meters above sea level	
Protection category ⁸⁾			IP 65	
Insulation class per DIN VDE 0530 section 1			F	
Housing finish			Basic black prime coat (RAL 9005)	
<p>1) Depending on torque requirements of the user. For standard applications see n_{max} in the selection lists of the motor/controller combination. For other applications, determine user speed using the required torque over the speed/torque characteristics.</p> <p>2) At 60 K overtemperature at the motor housing.</p> <p>3) The achievable maximum torque depends on the drive controller used. Only the maximum torque M_{max} for the motor/controller combinations found in the selection lists are binding.</p> <p>4) Without holding brake.</p> <p>5) At 1000 min⁻¹.</p> <p>6) For deviating ambient temperatures, see Section 3.1.</p> <p>7) For deviating installation elevations, see Section 3.1.</p> <p>8) Assuming correct mounting of power and feedback cables.</p>				

Fig. 6-1: Technical data MHD041

Designation	Symbol	Unit	Holding Brake Data
Motor type			MHD041B
Holding torque	M_H	Nm	2.2
Rated voltage	U_N	V	DC 24 \pm 10%
Rated current	I_N	A	0.4
Moment of inertia	J_B	kgm ²	0.16×10^{-4}
Link time	t_1	ms	19.0
Separating time	t_2	ms	28.0
Mass	m_B	kg	0.25

Fig. 6-2: Technical data of holding brake MHD041 (Option)

6.2 Speed/Torque Characteristics

For details see Section 3.11 Speed/Torque Characteristics .

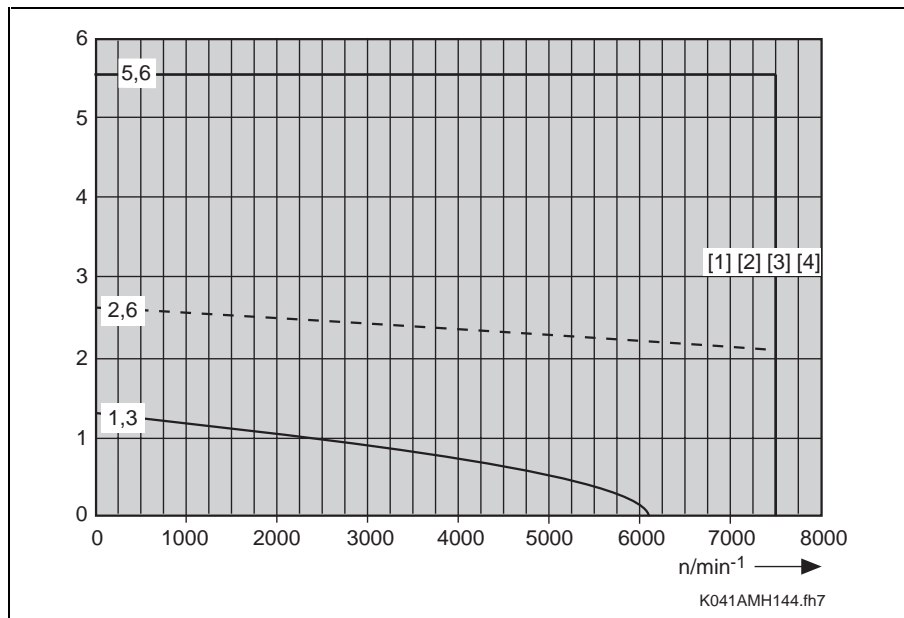

Fig. 6-3: Speed/torque characteristics MHD041A-144

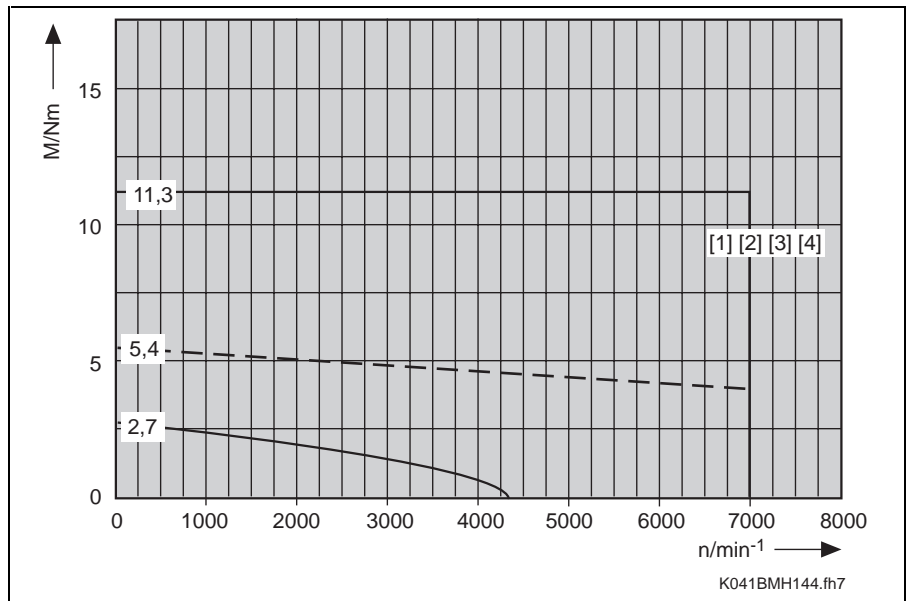

Fig. 6-4: Speed/torque characteristics MHD041B-144

6.3 Data for Determining Maximum Shaft Load

Allowable maximum radial force $F_{\text{radial_max}}$ and allowable radial force F_{radial}
 For details see Section 3.6 Output Shafts .

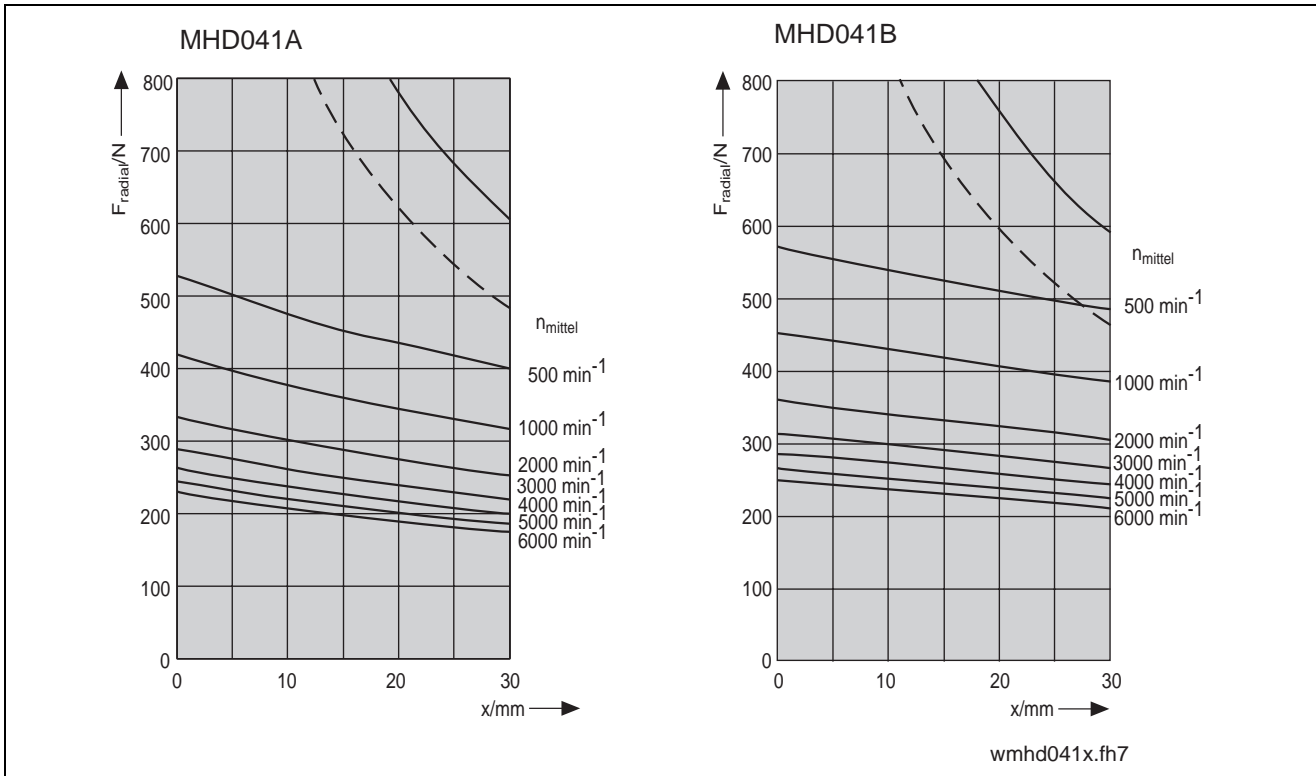

Fig. 6-5: MHD041: allowable maximum radial force $F_{\text{radial_max}}$ and allowable radial force F_{radial}

Allowable axial force F_{axial}

$$F_{\text{axial}} = x \cdot F_{\text{radial}}$$

x: **0.49** for MHD041A
0.45 for MHD041B

F_{axial} : Allowable axial force in N
 F_{radial} : allowable radial force in N

Fig. 6-6: MHD041: Allowable axial force F_{axial}

6.4 Dimensional Data

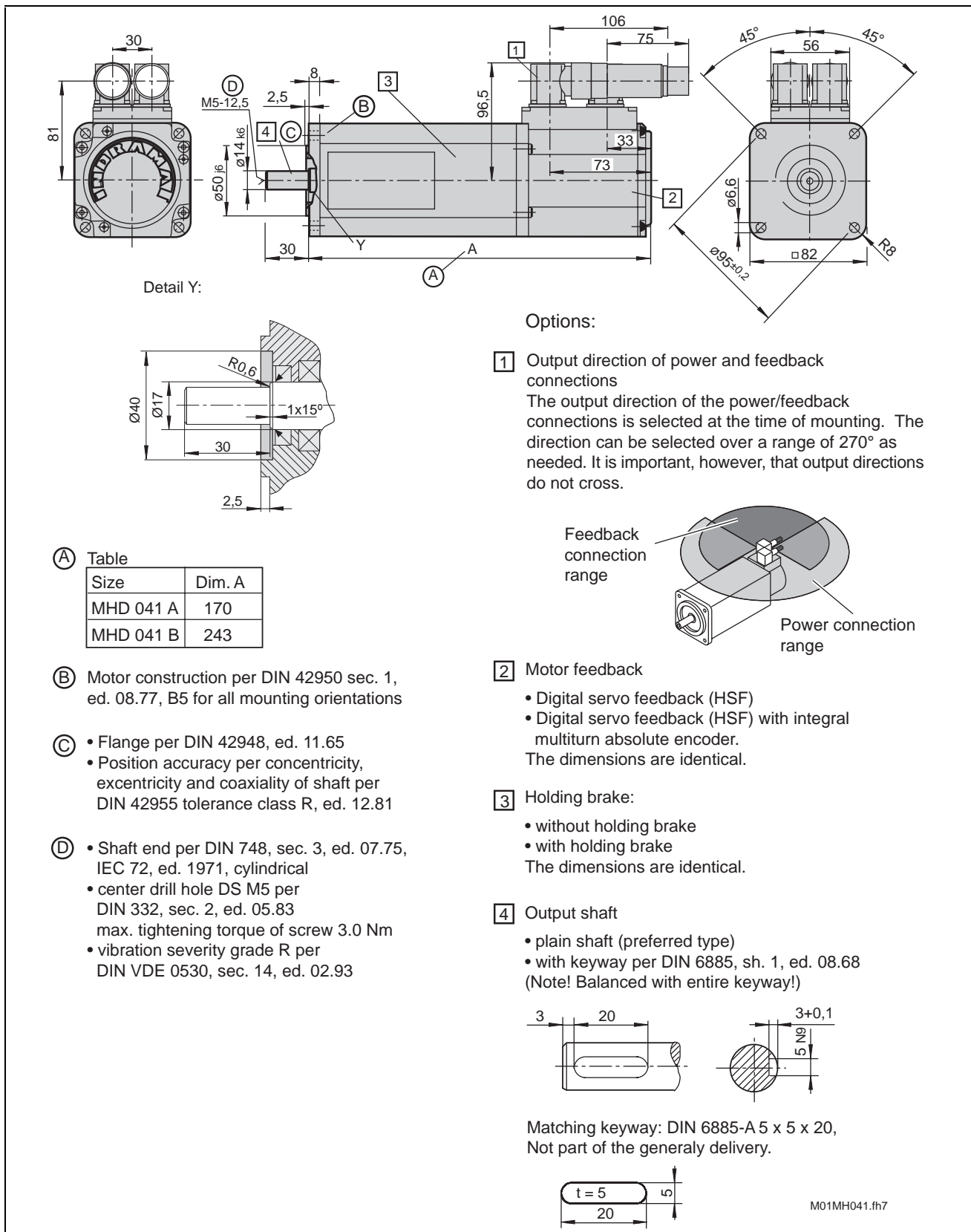

Fig. 6-7: Dimensional sheet - MHD041

6.5 Available Versions and Type Codes

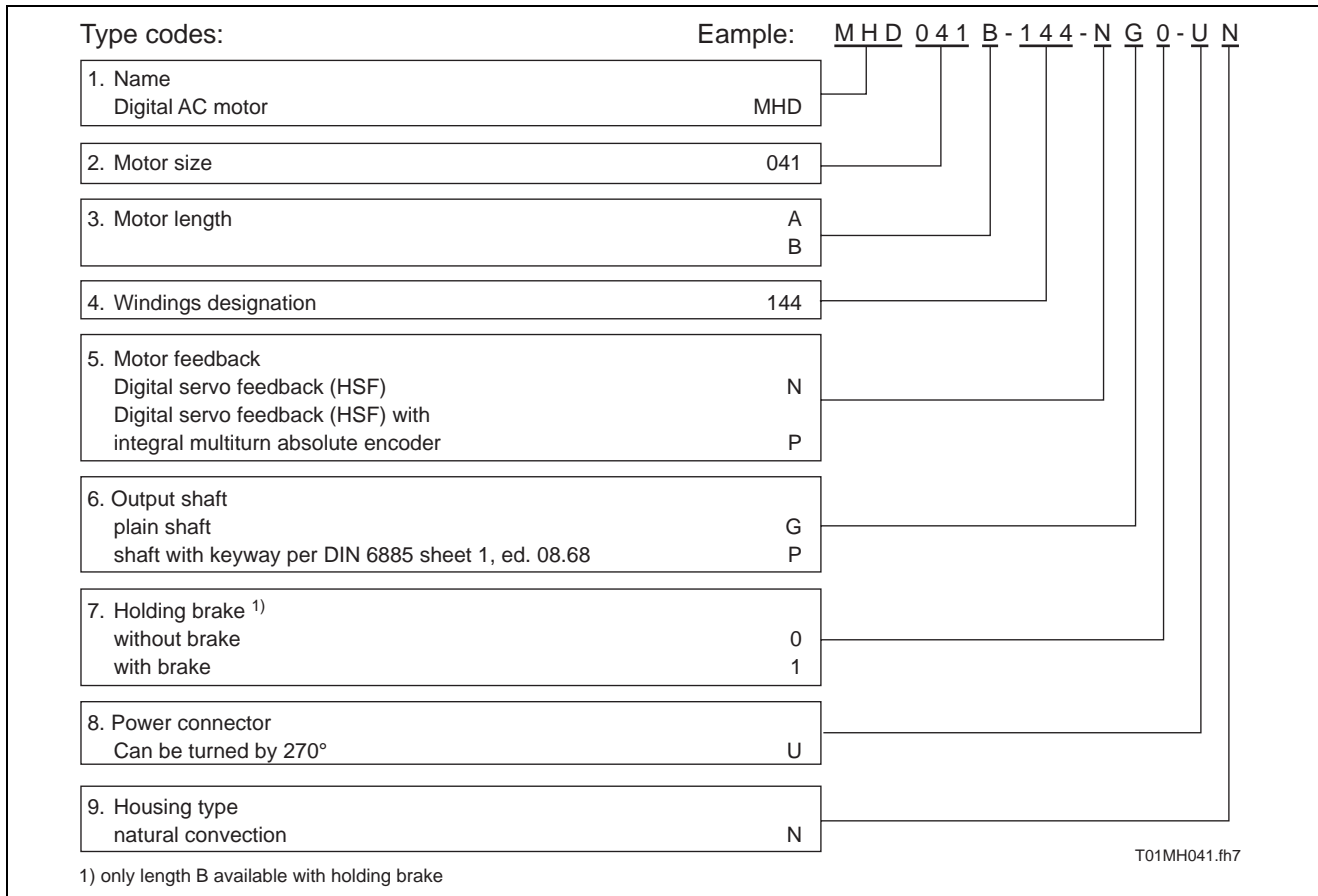

Fig. 6-8: Type Codes MHD041

7 MHD071

7.1 Technical Data

Designation		Symbol	Unit	Data		
Motor type				MHD071A-061	MHD071B-035	MHD071B-061
Rated motor speed ¹⁾		n	min ⁻¹	4500	2500	4500
Continuous torque at standstill ²⁾						
Cooling method	Natural convection	M _{dN}	Nm	3.5	8.0	8.0
	Surface cooling	M _{dN}	Nm	---	12.0	12.0
Continuous current at standstill						
Cooling method	Natural convection	I _{dN}	A	5.2	6.3	11.2
	Surface cooling	I _{dN}	A	---	9.5	16.8
Theoretical maximum torque ³⁾		M _{max}	Nm	14.0	32.0	32.0
Peak current		I _{max}	A	23.4	28.3	50.0
Rotor moment of inertia ⁴⁾		J _M	kgm ²	4.4 x 10 ⁻⁴	8.7 x 10 ⁻⁴	8.7 x 10 ⁻⁴
Torque constant at 20°C		K _m	Nm/A	0.76	1.38	0.77
Voltage constant at 20°C ⁵⁾		K _{Eeff}	V/1000 min ⁻¹	69.1	125.5	70.0
Windings resistance at 20°C		R _A	Ohm	5.2	4.6	1.45
Windings inductance		L _A	mH	16.0	23.0	7.2
Thermal time constant						
Cooling method	Natural convection	T _{th}	min	45	45	45
	Surface cooling	T _{th}	min	---	20	20
Mass ^{4) 9)}		m _M	kg	6.0	8.8	8.8
Allowed ambient temperature ⁶⁾		T _{um}	°C	0 to +45		
Allowed storage and transport temperature		T _L	°C	-20 to +80		
Maximum installation elevation ⁷⁾			m	1000 meters above sea level		
Protection category ⁸⁾				IP 65		
Insulation class per DIN VDE 0530 section 1				F		
Housing coat				Basic black prime coat (RAL 9005)		
<p>1) Depending on torque requirements of the user. For standard applications see n_{max} in the selection lists of the motor/controller combination. For other applications, determine user speed using the required torque over the speed/torque characteristics.</p> <p>2) At 60 K overtemperature at the motor housing.</p> <p>3) The achievable maximum torque depends on the drive controller used. Only the maximum torque M_{max} for the motor/controller combinations found in the selection lists are binding.</p> <p>4) Without holding brake.</p> <p>5) At 1000 min⁻¹.</p> <p>6) For deviating ambient temperatures, see Section 3.1.</p> <p>7) For deviating installation elevations, see Section 3.1.</p> <p>8) Assuming correct mounting of power and feedback cables.</p> <p>9) Without blower unit.</p>						

Fig. 7-1: Technical data MHD071

Designation	Symbol	Unit	Holding brake data
Motor type			MHD071B
Holding torque	M_H	Nm	5.0
Rated voltage	U_N	V	DC 24 $\pm 10\%$
Rated current	I_N	A	0.56
Moment of inertia	J_B	kgm ²	0.72×10^{-4}
Link time	t_1	ms	20
Separating time	t_2	ms	38
Mass	m_B	kg	0.6

Fig. 7-2: Technical data holding brake MHD071 (Option)

Designation	Symbol	Unit	Surface cooling data	
Rated voltage	U_N	V	1 x AC 230 $\pm 10\%$	1 x AC 115 $\pm 10\%$
Rated current	I_N	A	0.1	0.2
Power consumption	S_N	VA	18	17
Frequency	f	Hz	50	60

Fig. 7-3: Technical data surface cooling MHD071 (Option)

7.2 Speed/Torque Characteristics

For details see Section 3.11 Speed/Torque Characteristics .

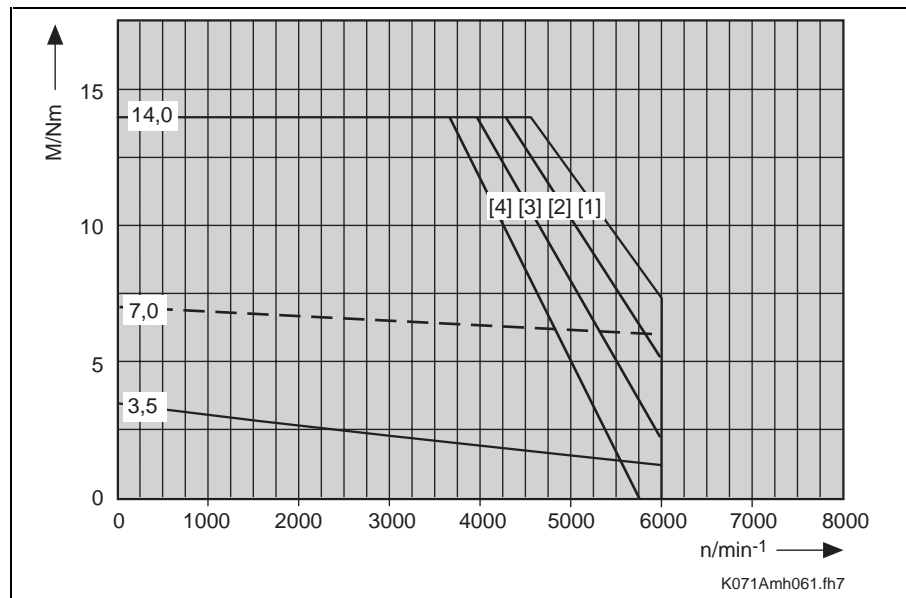

Fig. 7-4: Speed/torque characteristics MHD071A-061

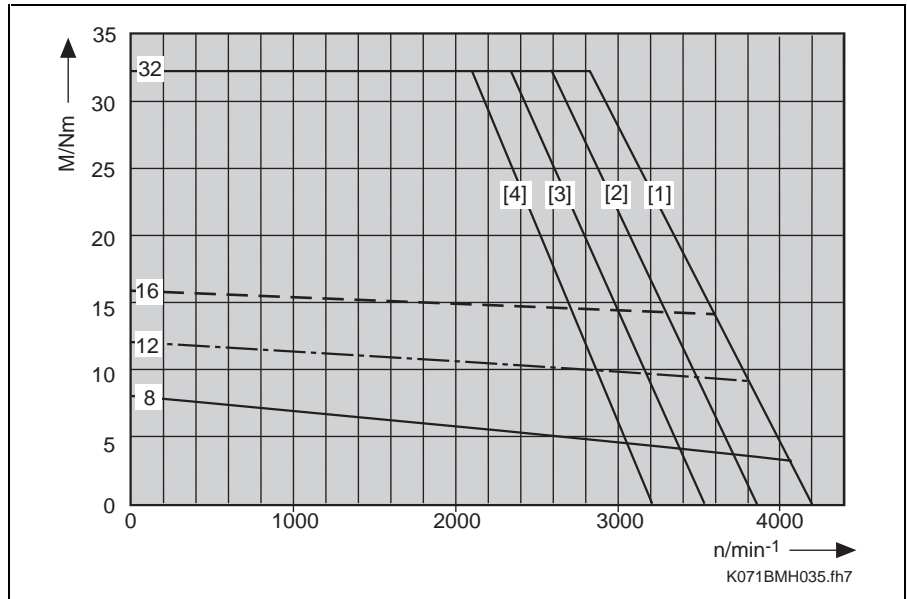

Fig. 7-5: Speed/torque characteristics MHD071B-035

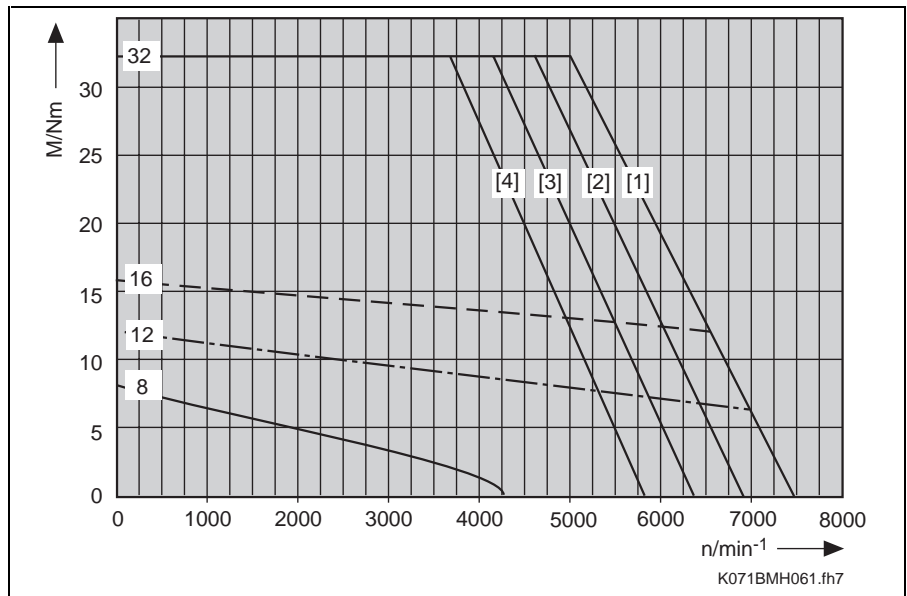

Fig. 7-6: Speed/torque characteristics MHD071B-061

7.3 Data for Determining Maximum Shaft Load

For details see Section "3.6 Output Shafts".

Allowable maximum radial force F_{radial_max} and allowable radial force F_{radial}

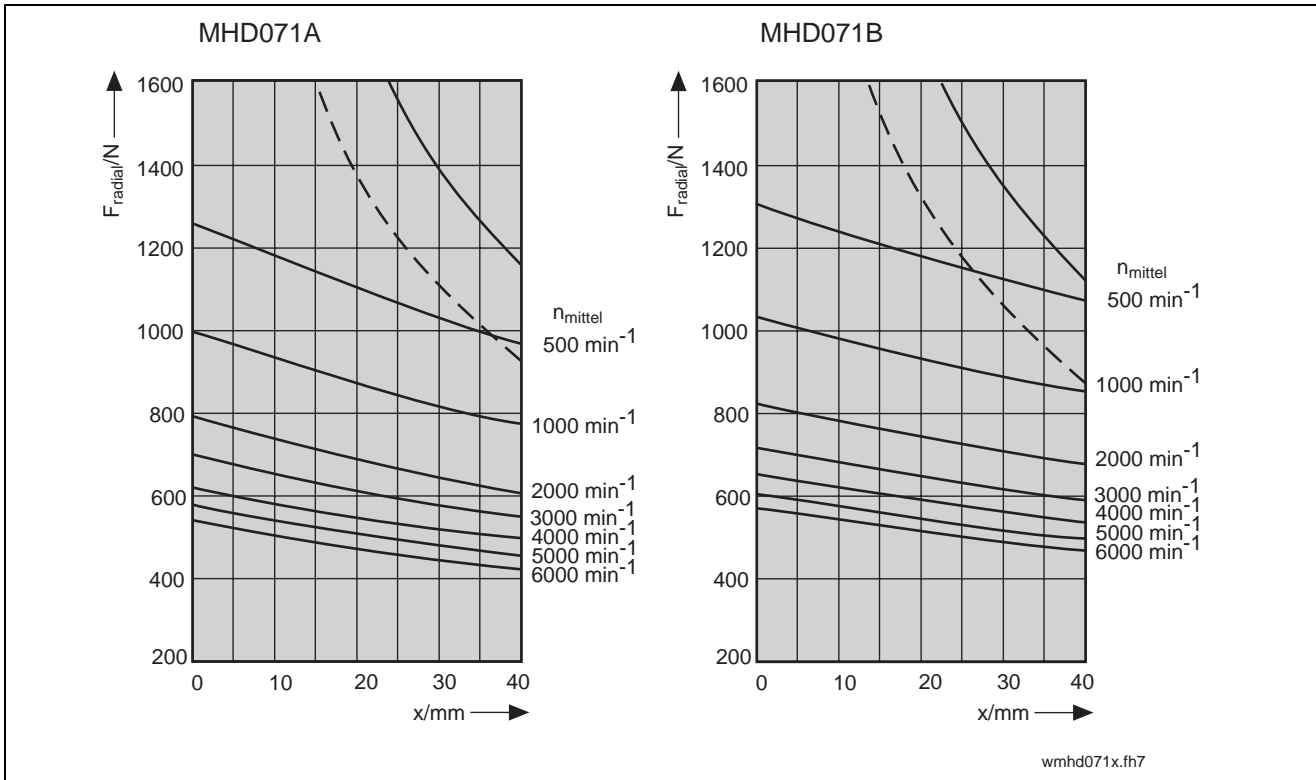

Fig. 7-7: MHD071: allowable maximum radial force F_{radial_max} and allowable radial force F_{radial}

Allowable axial force F_{axial}

$$F_{axial} = x \cdot F_{radial}$$

x: = **0.58** for MHD071A
 = **0.55** for MHD071B

F_{axial} : Allowable axial force in N

F_{radial} : allowable radial force in N

Fig. 7-8: MHD071: Allowable axial force F_{axial}

7.4 Dimensional Data

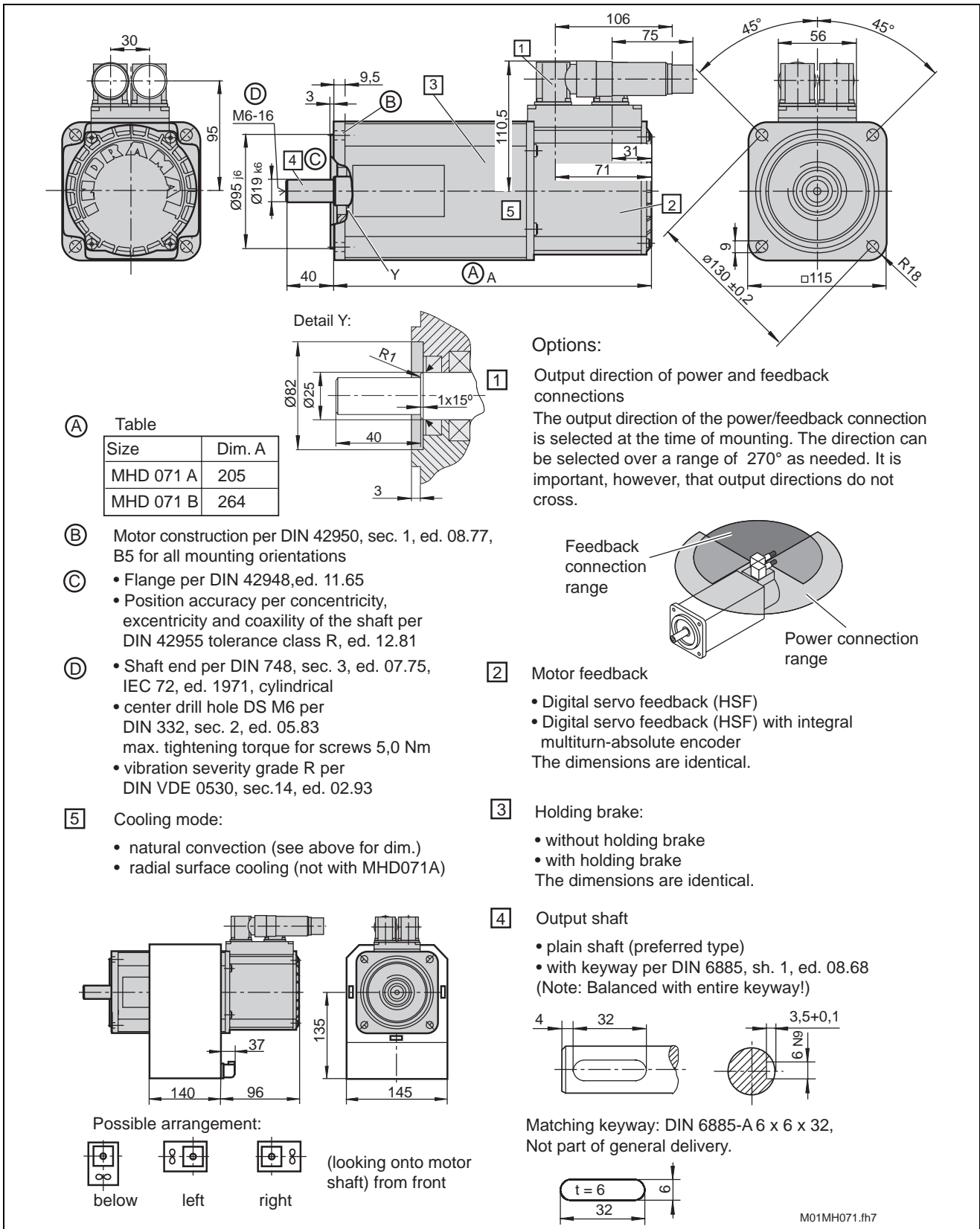

7.5 Available Versions and Type Codes

Type code:	Example:	M	H	D	0	7	1	B	-	0	6	1	-	N	G	0	-	U	N	
1. Name Digital AC Motor	MHD																			
2. Motor size	071																			
3. Motor length	A B																			
4. Windings designation	035 ¹⁾ 061																			
5. Motor feedback digital servo feedback (HSF) digital servo feedback (HSF) with integral multiturn absolute encoder	N P																			
6. Output shaft plain shaft with sealing ring shaft with keyway per DIN 6885 sheet 1, ed. 08.68	G P																			
7. Holding brake without brake with brake (5,0 Nm)	0 1 ²⁾																			
8. Power connection connector can be turned with 270°	U																			
9. Other versions none	N																			

1) Windings designation "035" only with length "B"
2) Holding brake "1" only with length "B"

T01MHH1P.fh7

Fig. 7-10: Type Codes MHD071

7.6 Surface cooling

Selection of blower unit

⇒ Selecting from following table the desired blower unit.

Motor type	Designation blower unit	
	AC 115V / 60Hz	AC 230V / 50Hz
MHD071A	---	---
MHD071B	LEMD-RB071B2XX	LEMD-RB071B1XX
--- blower unit not possible		

Fig. 7-11: Blower units MHD071

Motor with mounted blower unit

If you want to order a motor with mounted surface cooling then specify the above-referenced type designation for radial blower units and list it as a subitem of the MHD motor and specify blower arrangement.

Order position	Designation
1	1 x digital AC- motor MHD071B-035-NG0-BN
1.1	1 x blower unit LEMD-RB071B2XX mounted to pos. 1 blower arrangement left

Fig. 7-12: Order information for MHD motor with mounted blower unit

Motor with separate blower unit

If the blower unit is listed as a separate item, then it will be delivered separate of the motor (i.e., not mounted).

Order position	Designation
1	1 x digital AC- motor MHD071B-035-NG0-BN
2	1 x blower unit LEMD-RB071B2XX

Fig. 7-13: Order information for MHD motor with separate blower unit

8 MHD090

8.1 Technical Data

Designation		Symbol	Unit	Data		
Motor type				MHD090B-035	MHD090B-047	MHD090B-058
Rated motor speed ¹⁾		n	min ⁻¹	2500	3200	4000
Continuous torque at standstill ²⁾						
Cooling method	Natural convection	M _{dN}	Nm	12.0	12.0	12.0
	Surface cooling	M _{dN}	Nm	18.0	18.0	18.0
Continuous current at standstill						
Cooling method	Natural convection	I _{dN}	A	11.0	13.2	17.5
	Surface cooling	I _{dN}	A	16.5	19.8	26.3
Theoretical maximum torque ³⁾		M _{max}	Nm	43.5	43.5	43.5
Peak current		I _{max}	A	49.5	59.4	79.0
Rotor moment of inertia ⁴⁾		J _M	kgm ²	43.0 x 10 ⁻⁴	43.0 x 10 ⁻⁴	43.0 x 10 ⁻⁴
Torque constant at 20°C		K _m	Nm/A	1.22	1.0	0.77
Voltage constant at 20°C ⁵⁾		K _{Eeff}	V/1000 min ⁻¹	111.0	91.0	70.0
Windings resistance at 20°C		R _A	Ohm	1.88	1.2	0.74
Windings inductance		L _A	mH	15,5	10.1	5.8
Thermal time constant						
Cooling method	Natural convection	T _{th}	min	60	60	60
	Surface cooling	T _{th}	min	30	30	30
Mass ^{4) 9)}		m _M	kg	14	14	14
Allowed ambient temperature ⁶⁾		T _{um}	°C	0 to +45		
Allowed storage and transport temperature		T _L	°C	-20 to +80		
Maximum installation elevation ⁷⁾			m	1000 meters above sea level		
Protection category ⁸⁾				IP 65		
Insulation class per DIN VDE 0530 section 1				F		
Housing coat				Basic black prime coat (RAL 9005)		

1) Depending on torque requirements of the user. For standard applications see n_{max} in the selection lists of the motor/controller combination. For other applications, determine user speed using the required torque over the speed/torque characteristics.
2) At 60 K overtemperature at the motor housing.
3) The achievable maximum torque depends on the drive controller used. **Only** the maximum torque M_{max} for the motor/controller combinations found in the selection lists are binding.
4) Without holding brake.
5) At 1000 min⁻¹.
6) For deviating ambient temperatures, see Section 3.1.
7) For deviating installation elevations, see Section 3.1.
8) Assuming correct mounting of power and feedback cables.
9) Without holding break.

Fig. 8-1: Technical data MHD090

Designation	Symbol	Unit	Holding brake data
Motortyp			MHD090B
Haltemoment	M_H	Nm	11
Rated voltage	U_N	V	DC 24 \pm 10%
Rated current	I_N	A	0.71
Moment of inertia	J_B	kgm ²	3.6×10^{-4}
Separating time	t_2	ms	13
Link time	t_1	ms	30
Mass	m_B	kg	1.1

Fig. 8-2: Technical data holding brake MHD090 (Option)

Designation	Symbol	Unit	Surface cooling data	
Rated voltage	U_N	V	1 x AC 230 \pm 10%	1 x AC 115 \pm 10%
Rated current	I_N	A	0.2	0.4
Power consumption	S_N	VA	40	39
Frequency	f	Hz	50	60

Fig. 8-3: Technical data surface cooling MHD090 (Option)

8.2 Speed/Torque Characteristics

For details see Section 3.11 Speed/Torque Characteristics .

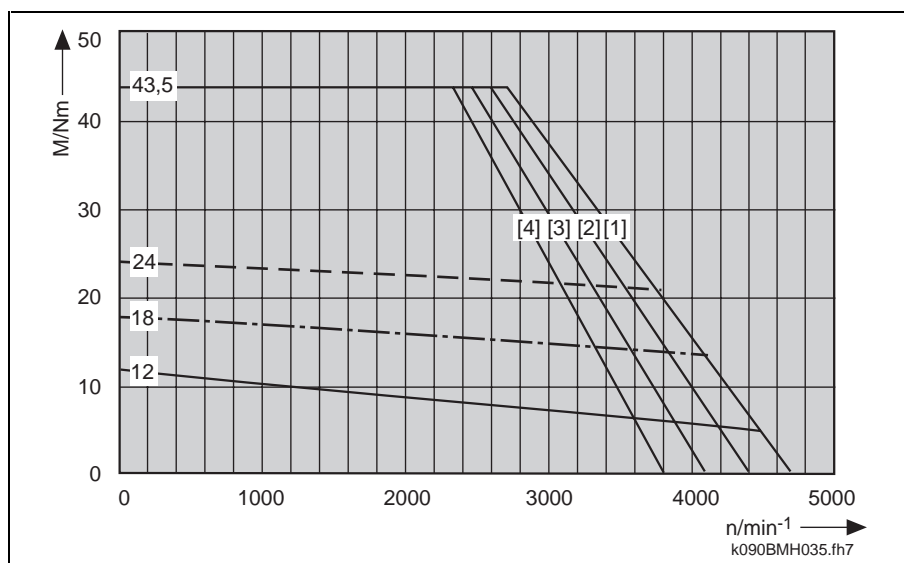

Fig. 8-4: Speed/torque characteristics MHD090B-035

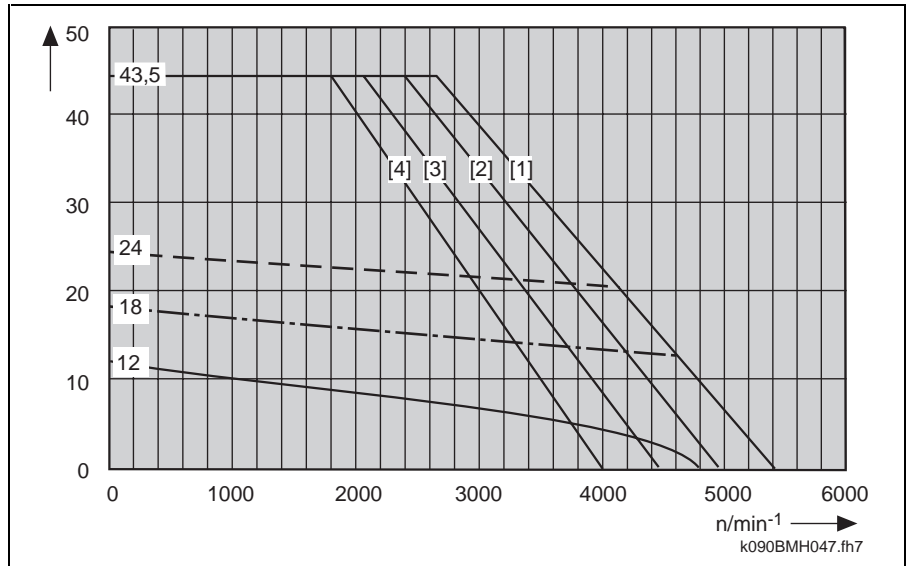

Fig. 8-5: Speed/torque characteristics MHD090B-047

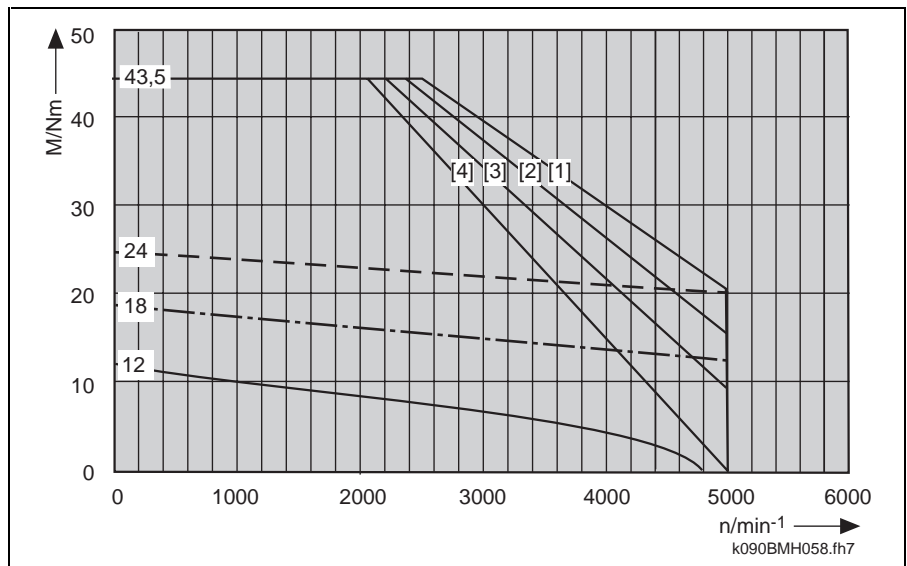

Fig. 8-6: Speed/torque characteristics MHD090B-058

8.3 Data for Determining Shaft Capacity

For details see Section 3.6 Output Shafts .

Allowable maximum radial force $F_{\text{radial_max}}$ and allowable radial force F_{radial}

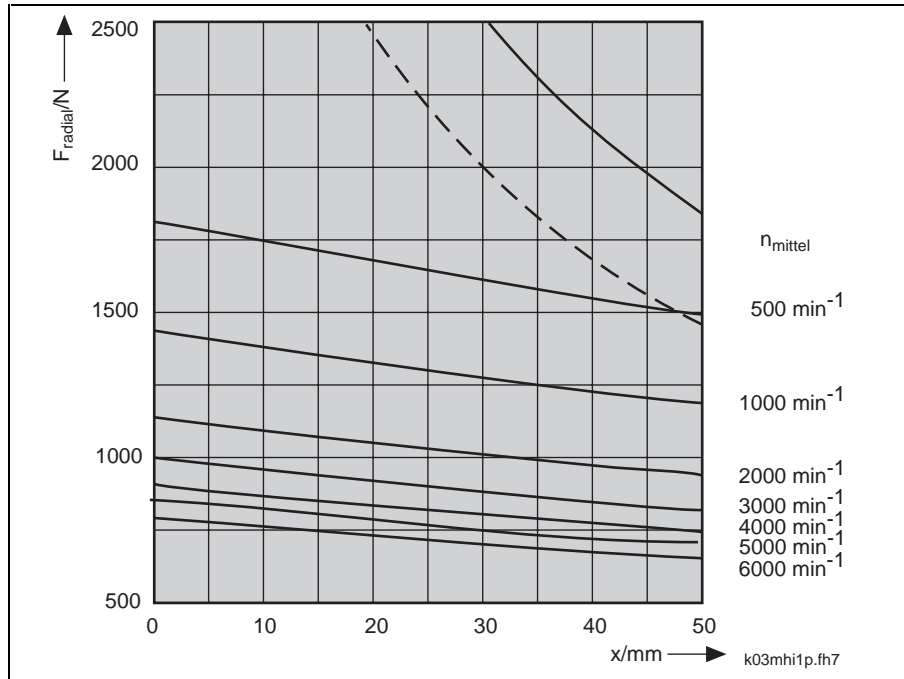

Fig. 8-7: MHD090: allowable maximum radial force $F_{\text{radial_max}}$ and allowable radial force F_{radial}

Allowable axial force F_{axial}

$$F_{\text{axial}} = 0,34 \cdot F_{\text{radial}}$$

F_{axial} : Allowable axial force in N
 F_{radial} : allowable radial force in N

Fig. 8-8: MHD090: Allowable axial force F_{axial}

8.4 Dimensional Data

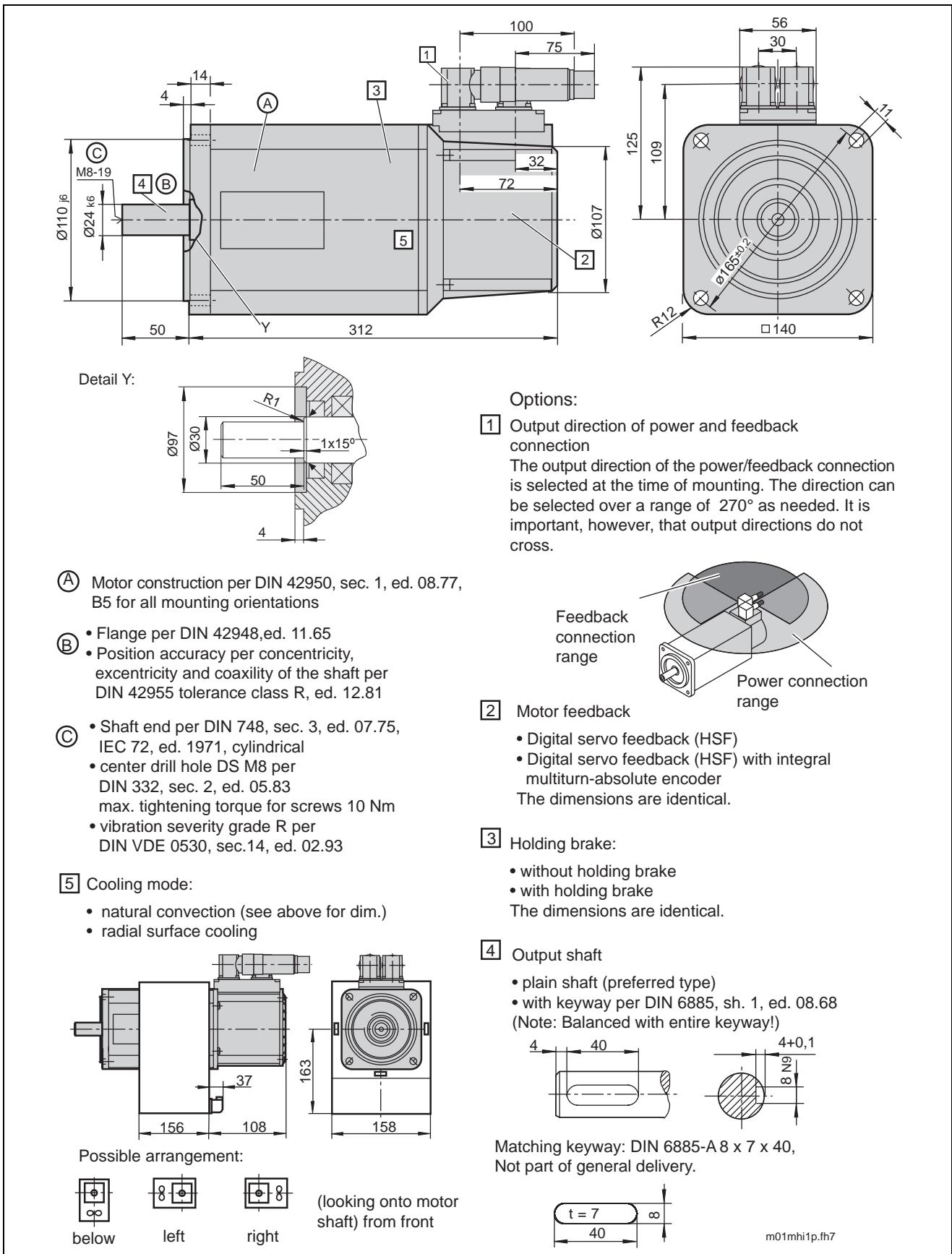

Fig. 8-9: Dimensional sheet - MHD090

8.5 Available Versions and Type Codes

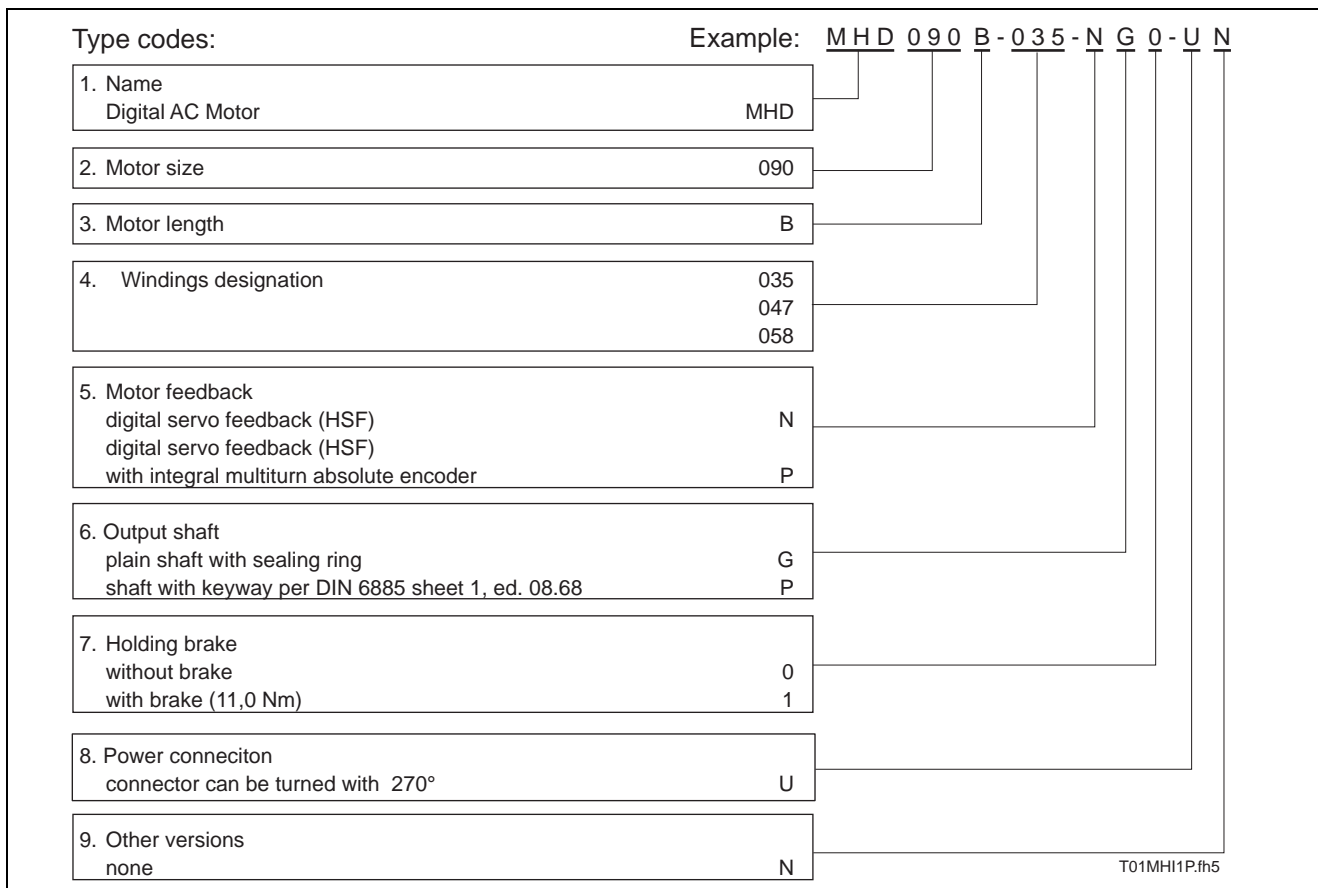

Fig. 8-10: Type Codes MHD090

8.6 Surface cooling

Selection of blower unit

⇒ Selecting from following table the desired blower unit.

Motor type	Designation blower unit	
	AC 115V / 60Hz	AC 230V / 50Hz
MHD090B	LEMH-RB090B2XX	LEMH-RB090B1XX

Fig. 8-11: Lüftereinheiten MHD093

Motor with mounted blower unit

If you want to order a motor with mounted surface cooling then specify the above-referenced type designations of the radial blower unit as a subitem of the MHD motor with the desired blower arrangement.

Order position	Designation
1	1x digital AC motor MHD090B-035-NG0-BN
1.1	1x blower unit LEMH-RB090B1-XX mounted to pos. 1 blower arrangement left

Fig. 8-12: Order information for MHD motor with mounted blower unit

Motor with separate blower unit

If the blower unit is listed as a separate order position, then it will be delivered separate of the motor (i.e., not mounted).

Order position	Designation
1	1x digital AC motor MHD090B-035-NG0-BN
2	1x blower unit LEMH-RB090B1-XX

Fig. 8-13: Order information for MHD motor with separate blower unit

9 MHD093

9.1 Technical Data

Designation		Symbol	Unit	Data		
Motor type				MHD093A-024	MHD093A-035	MHD093A-058
Rated motor speed ¹⁾		n	min ⁻¹	2000	3000	4000
Continuous torque at standstill ²⁾						
Cooling method	Natural convection	M _{dN}	Nm	12.0	12.0	12.0
	liquid cooled	M _{dN}	Nm	---	---	---
Continuous current at standstill						
Cooling method	Natural convection	I _{dN}	A	7.6	10.4	12.8
	liquid cooled	I _{dN}	A	---	---	---
Theoretical maximum torque ³⁾		M _{max}	Nm	44.0	44.0	44.0
Peak current		I _{max}	A	34.2	46.8	57.6
Rotor moment of inertia ⁴⁾		J _M	kgm ²	17.3 x 10 ⁻⁴	17.3 x 10 ⁻⁴	17.3 x 10 ⁻⁴
Torque constant at 20°C		K _m	Nm/A	1.77	1.29	1.05
Voltage constant at 20°C ⁵⁾		K _{Eeff}	V/1000 min ⁻¹	154.0	112.2	91.3
Windings resistance at 20°C		R _A	Ohm	2.95	1.75	1.09
Windings inductance		L _A	mH	19.3	10.8	6.9
Thermal time constant						
Cooling method	Natural convection	T _{th}	min	40	40	40
	liquid cooled	T _{th}	min	---	---	---
Mass ⁴⁾		m _M	kg	14.5	14.5	14.5
Allowed ambient temperature ⁶⁾		T _{um}	°C	0 to +45		
Allowed storage and transport temperature		T _L	°C	-20 to +80		
Maximum installation elevation ⁷⁾			m	1000 meters above sea level		
Protection category ⁸⁾				IP 65		
Insulation class per DIN VDE 0530 section 1				F		
Housing coat				Basic black prime coat (RAL 9005)		

1) Depending on torque requirements of the user. For standard applications see n_{max} in the selection lists of the motor/controller combination. For other applications, determine user speed using the required torque over the speed/torque characteristics.
2) At 60 K overtemperature at the motor housing.
3) The achievable maximum torque depends on the drive controller used. **Only** the maximum torque M_{max} for the motor/controller combinations found in the selection lists are binding.
4) Without holding brake.
5) At 1000 min⁻¹.
6) For deviating ambient temperatures, see Section 3.1 .
7) For deviating installation elevations, see Section 3.1 .
8) Assuming correct mounting of power and feedback cables.

Fig. 9-1: Technical data MHD093

Designation		Symbol	Unit	Data			
Motor type				MHD093B-035	MHD093B-058	MHD093C-035	MHD093C-058
Rated motor speed ¹⁾		n	min ⁻¹	2500	4000	2500	4000
Continuous torque at standstill ²⁾							
Cooling method	Natural convection	M _{dN}	Nm	17.5	17.5	23.0	23.0
	Surface cooling	M _{dN}	Nm	26.3	26.3	34.5	34.5
	liquid cooled	M _{dN}	Nm	33.3	33.3	43.7	43.7
Continuous current at standstill							
Cooling method	Natural convection	I _{dN}	A	12.8	22.5	18.5	28.3
	Surface cooling	I _{dN}	A	19.2	33.8	27.8	42.5
	liquid cooled	I _{dN}	A	24.3	42.8	35.2	53.8
Theoretical maximum torque ³⁾		M _{max}	Nm	66.0	66.0	88.0	88.0
Peak current		I _{max}	A	58.0	101.2	83.5	127.4
Rotor moment of inertia ⁴⁾		J _M	kgm ²	25 x 10 ⁻⁴	25 x 10 ⁻⁴	30 x 10 ⁻⁴	30 x 10 ⁻⁴
Torque constant at 20°C		K _m	Nm/A	1.5	0.87	1.39	0.91
Voltage constant at 20°C ⁵⁾		K _{Eeff}	V/1000 min ⁻¹	136.0	79.0	126.0	82.7
Windings resistance at 20°C		R _A	Ohm	1.26	0.44	0.79	0.32
Windings inductance		L _A	mH	10.7	3.2	6.2	2.6
Thermal time constant							
Cooling method	Natural convection	T _{th}	min	60	60	75	75
	Surface cooling	T _{th}	min	30	30	35	35
	liquid cooled	T _{th}	min	20	20	25	25
Mass ^{4) 9)}		m _M	kg	19.0	19.0	23.5	23.5
Allowed ambient temperature ⁶⁾		T _{um}	°C	0 to +45			
Allowed storage and transport temperature		T _L	°C	-20 to +80			
Maximum installation elevation ⁷⁾			m	1000 meters above sea level			
Protection category ⁸⁾				IP 65			
Insulation class per DIN VDE 0530 section 1				F			
Housing coat				Basic black prime coat (RAL 9005)			

1) Depending on torque requirements of the user. For standard applications see n_{max} in the selection lists of the motor/controller combination. For other applications, determine user speed using the required torque over the speed/torque characteristics.
2) At 60 K overtemperature at the motor housing.
3) The achievable maximum torque depends on the drive controller used. **Only** the maximum torque M_{max} for the motor/controller combinations found in the selection lists are binding.
4) Without holding brake.
5) At 1000 min⁻¹.
6) For deviating ambient temperatures, see Section 3.1 .
7) For deviating installation elevations, see Section 3.1 .
8) Assuming correct mounting of power and feedback cables.
9) Without blower unit.

Fig. 9-2: Technical data MHD093

Designation	Symbol	Unit	Holding brake data
Motor type			MHD093A MHD093B MHD093C
Holding torque	M_H	Nm	22
Rated voltage	U_N	V	DC 24 \pm 10%
Rated current	I_N	A	0.71
Moment of inertia	J_B	kgm ²	3.6×10^{-4}
Separating time	t_2	ms	50
Link time	t_1	ms	25
Mass	m_B	kg	1.1

Fig. 9-3: Technical data holding brake MHD093 (Option)

Designation	Symbol	Unit	Data	
Motor type			MHD093B...	MHD093C...
Rated power loss	P_{VN}	W	900	1000
Entry temperature of coolant ¹⁾	ϑ_{ein}	°C	+10 ... +40	
Coolanttemperaturerhöhung bei P_{VN}	$\Delta\vartheta_N$	°C	10	
Minimum required coolant flowthrough at $\Delta\vartheta_N$ ²⁾	Q_N	l/min	1.3	1.4
Pressure drop with Q_N ²⁾³⁾	Δp_N	bar	0.6	0.7
Maximum system pressure	p_{max}	bar	3.0	
Coolant channel volume	V	l	0.05	0.06
1) Note relationship between entry temp. of coolant and act. ambient temp.: entry temp. max not exceed 5°C below actual ambient temperature (otherwise danger of condensation)! 2) if coolant is water 3) for deviating flowthrough values of flow diagram (see Section 5).				

Fig. 9-4: Technical data liquid cooling MHD093

Designation	Symbol	Unit	Surface cooling data	
Rated voltage	U_N	V	1 x AC 230 \pm 10%	1 x AC 115 \pm 10%
Rated current	I_N	A	0,2	0,4
Power consumption	S_N	VA	40	39
Frequency	f	Hz	50	60

Fig. 9-5: Technical data surface cooling MHD093 (Option)

9.2 Speed/Torque Characteristics

For details see Section 3.11 Speed/Torque Characteristics

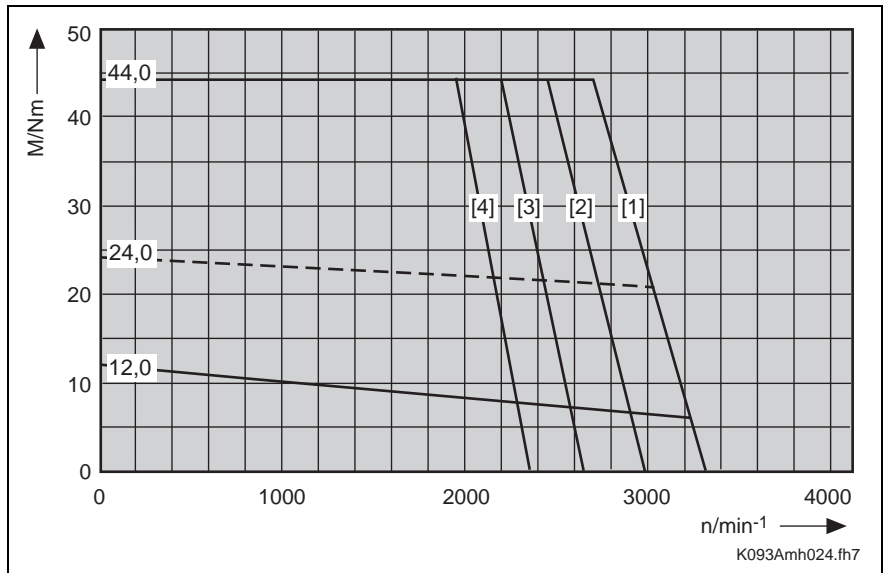

Fig. 9-6: Speed/torque characteristics MHD093A-024

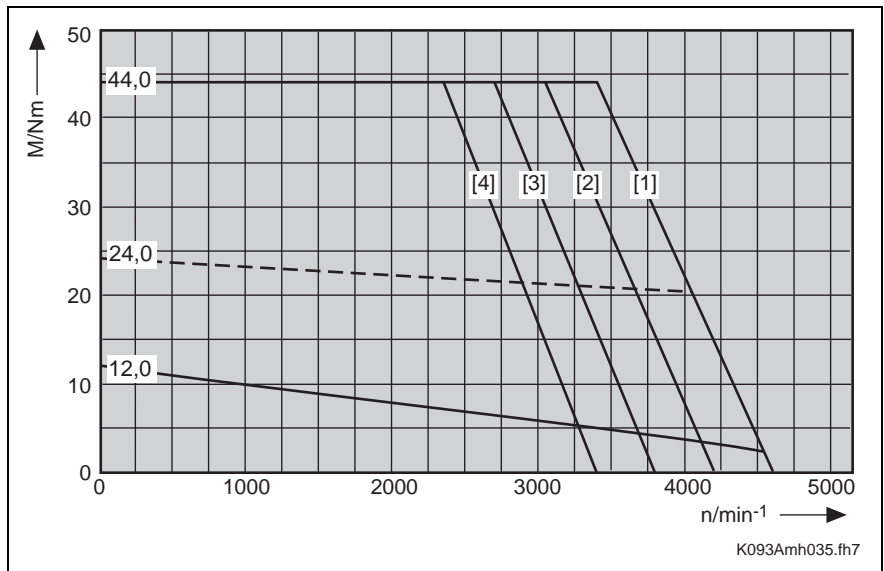

Fig. 9-7: Speed/torque characteristics MHD093A-035

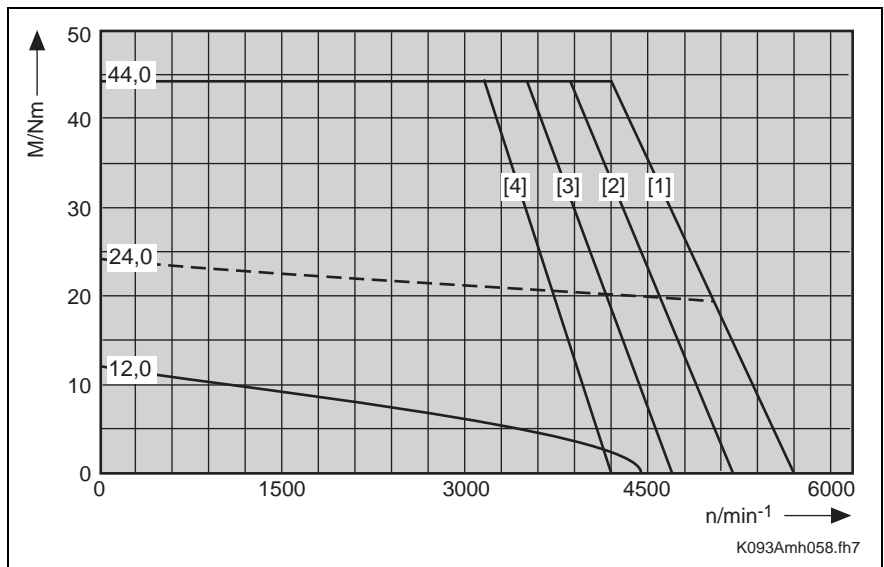

Fig. 9-8: Speed/torque characteristics MHD093A-058

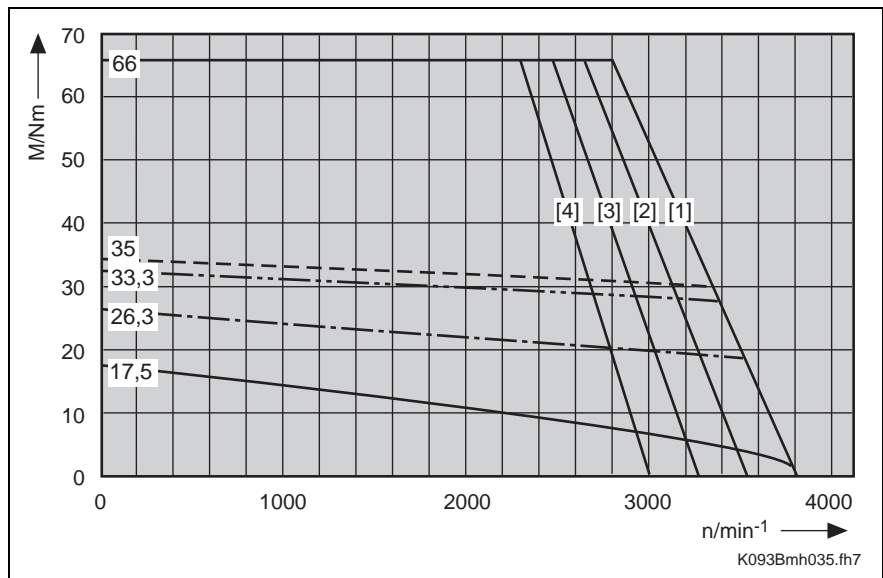

Fig. 9-9: Speed/torque characteristics MHD093B-035

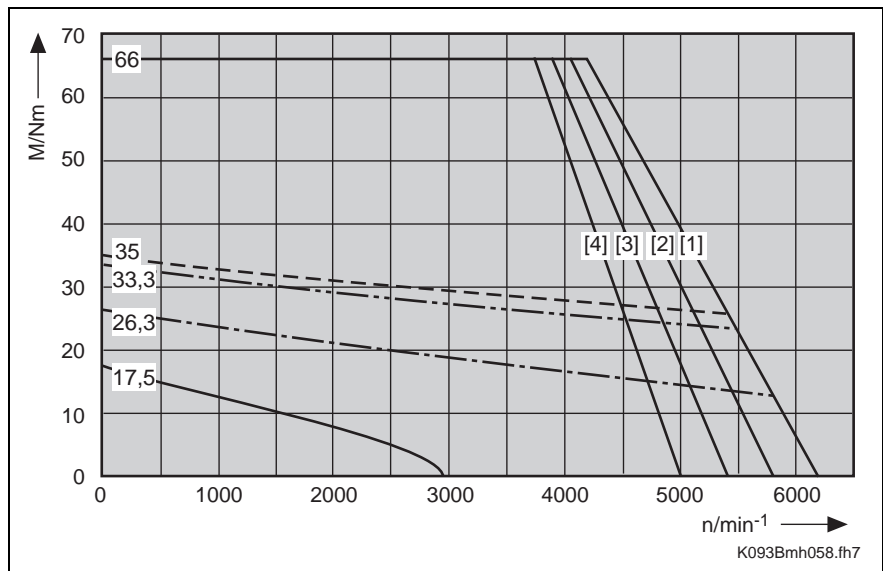

Fig. 9-10: Speed/torque characteristics MHD093B-058

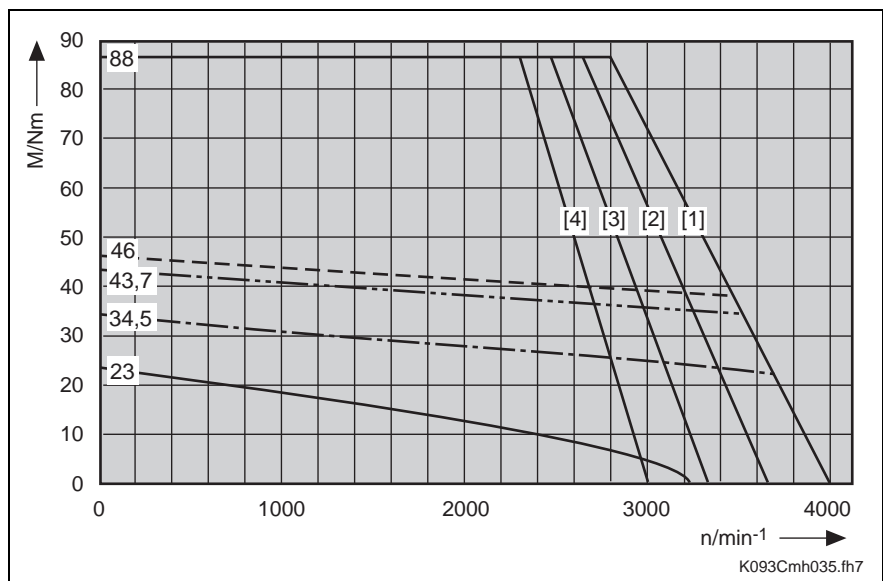

Fig. 9-11: Speed/torque characteristics MHD093C-035

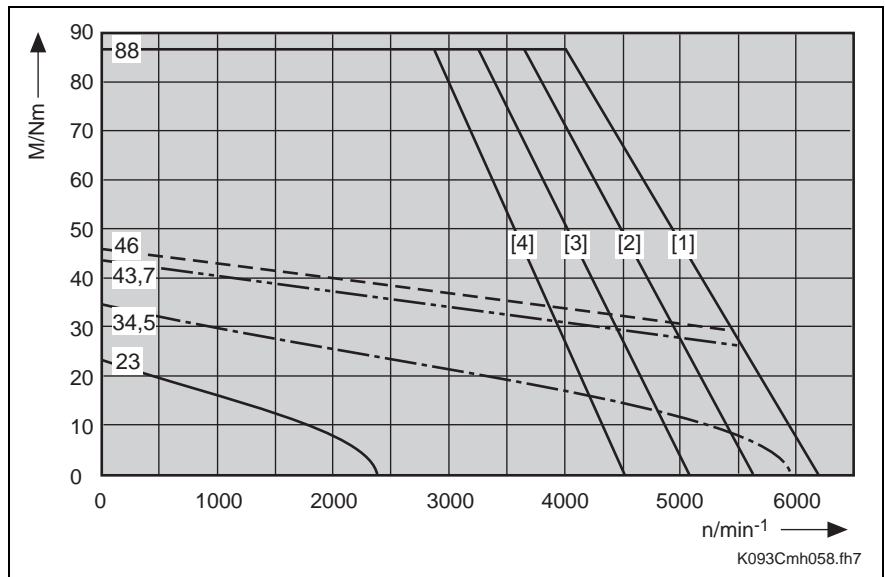

Fig. 9-12: Speed/torque characteristics MHD093C-058

9.3 Data on Determining Maximum Shaft Load

Allowable maximum radial force F_{radial_max} and allowable radial force F_{radial}

For details see Section „ 3.6 Output Shafts“.

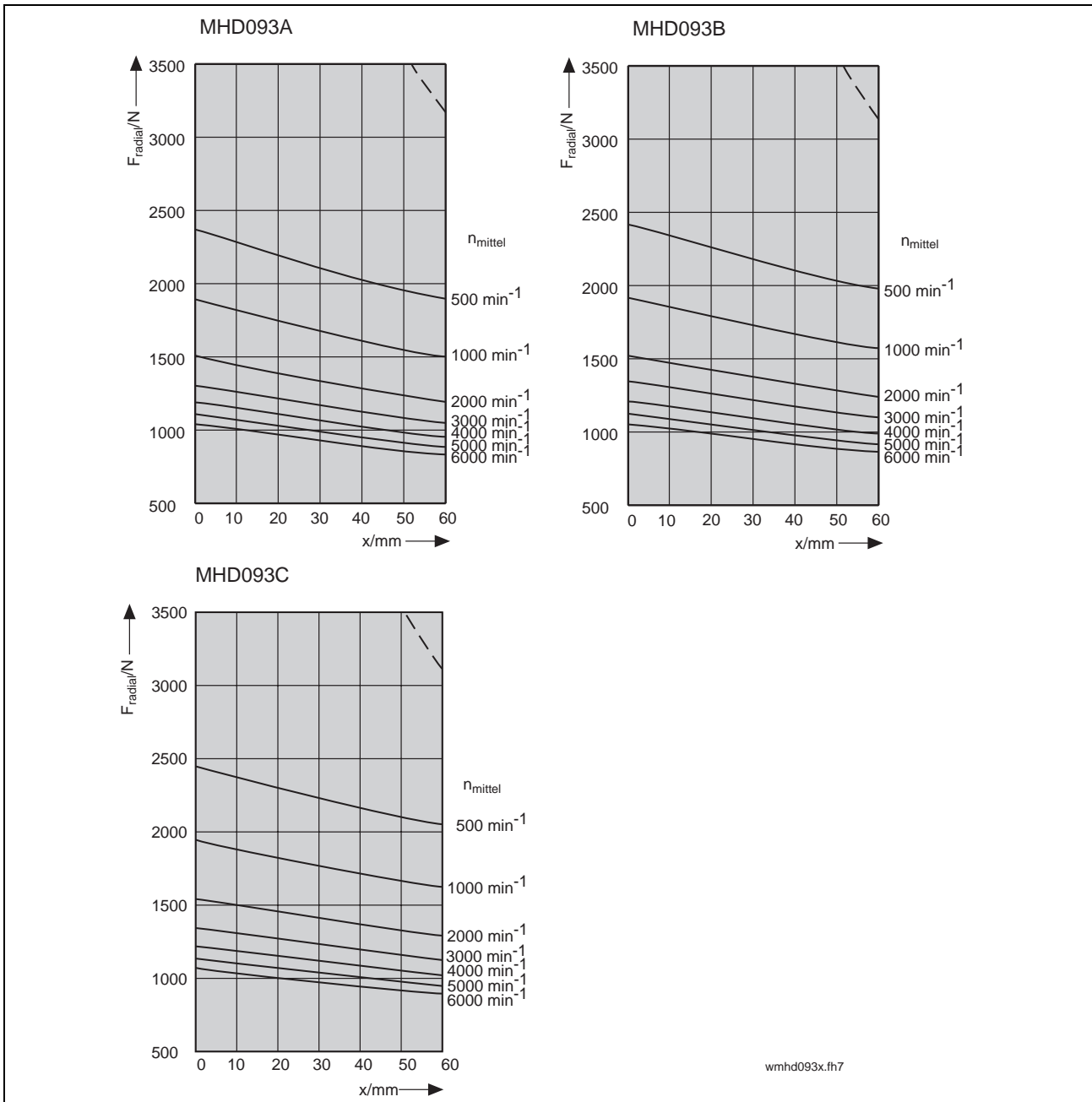

Fig. 9-13: MHD093: allowable maximum radial force F_{radial_max} and allowable radial force F_{radial}

Allowable axial force F_{axial}

$$F_{axial} = 0,24 \cdot F_{radial}$$

F_{axial} : Allowable axial force in N
 F_{radial} : allowable radial force in N

Fig. 9-14: MHD093: Allowable axial force F_{axial}

9.4 Dimensional Data (Standard cooling)

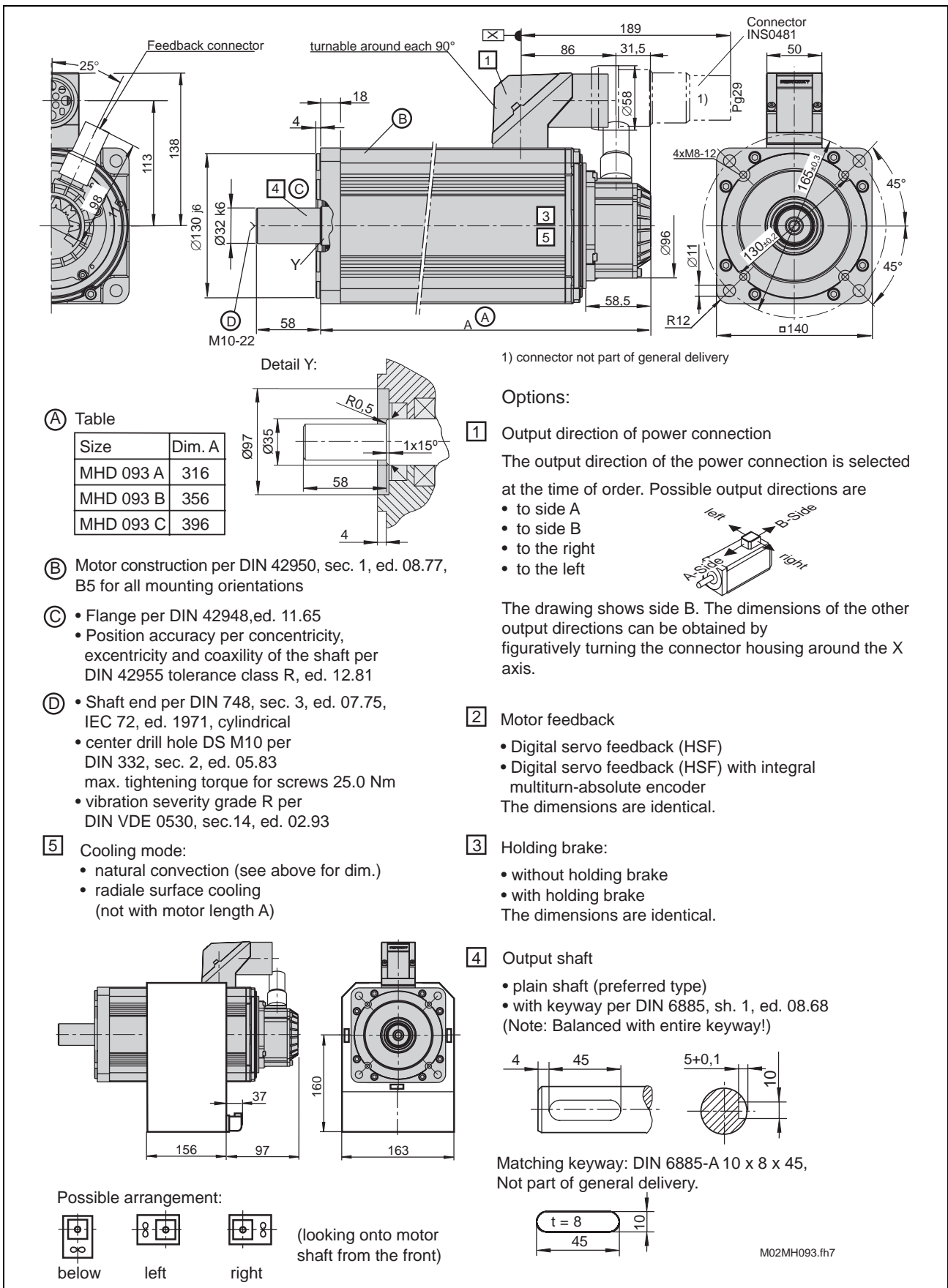

Fig. 9-15: Dimensional sheet MHD093.-...-...-A

9.5 Dimensional Data (Liquid cooling)

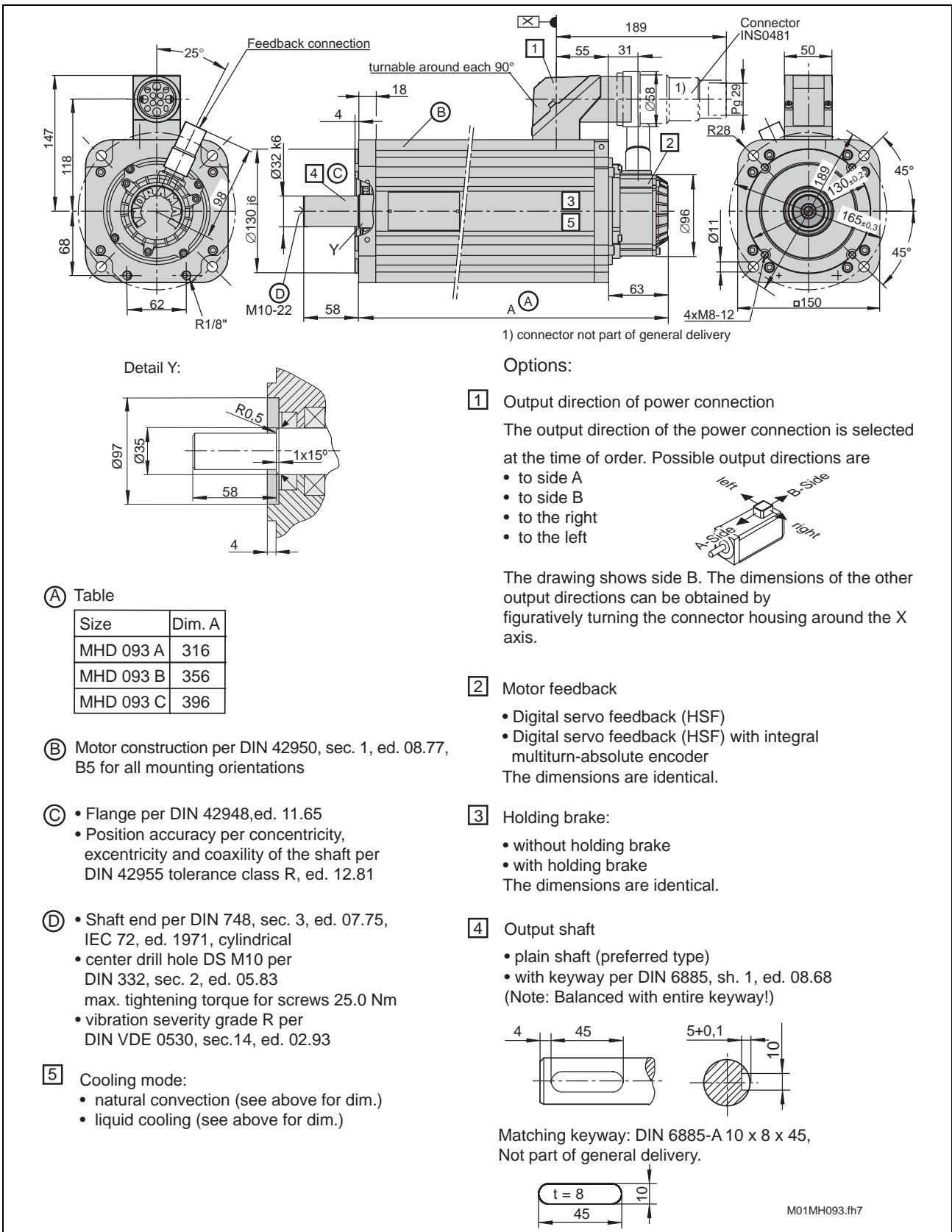

Fig. 9-16: Dimensional sheet MHD093.-...-...-N

9.6 Available Versions and Type Codes

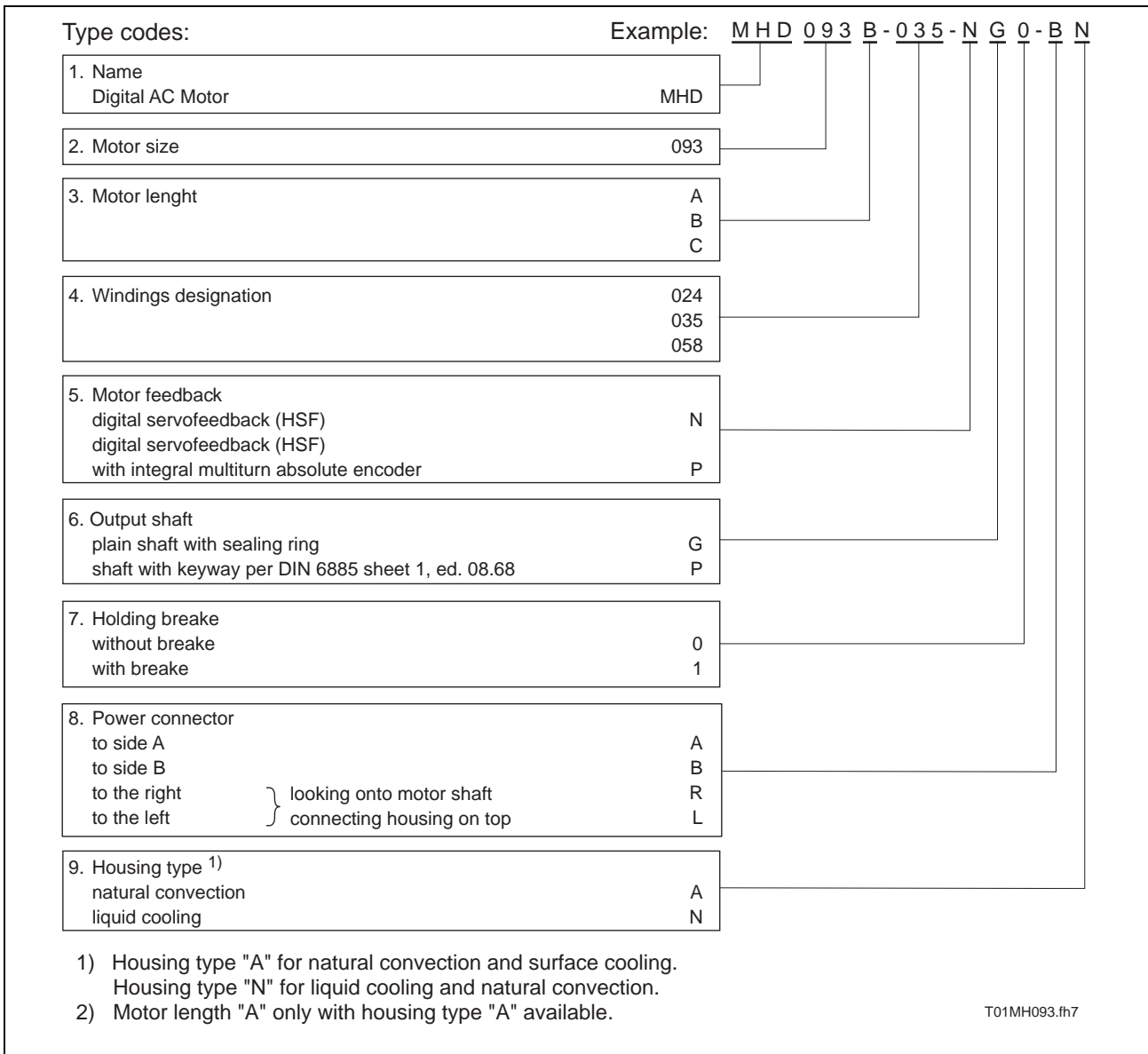

Fig. 9-17: Type Codes MHD093

9.7 Surface cooling

Selection of blower unit

Selecting from following table the desired blower unit.

Motor type	Designation blower unit	
	AC 115V / 60Hz	AC 230V / 50Hz
MHD093A-...-...-A	---	---
MHD093B-...-...-A	LEMD-RB090B2XX	LEMD-RB090B1XX
MHD093C-...-...-A	LEMD-RB090B2XX	LEMD-RB090B1XX
--- blower unit not possible		

Fig. 9-18: Blower units MHD093

Motor with mounted blower unit

If you want to order a motor with mounted surface cooling then specify the above-referenced type designation for radial blower units and list it as a subitem of the MHD motor and specify blower arrangement.

Order position	Designation
1	1 x digital AC- motor MHD093B-035-NG0-BN
1.1	1 x blower unit LEMD-RB093B2XX mounted to pos. 1 blower arrangement left

Fig. 9-19: Order information for MHD motor with mounted blower unit

Motor with separate blower unit

If the blower unit is listed as a separate item, then it will be delivered separate of the motor (i.e., not mounted).

Order position	Designation
1	1 x digital AC- motor MHD093B-035-NG0-BN
2	1 x blower unit LEMD-RB090B2XX

Fig. 9-20: Order information for MHD motor with separate blower unit

10 MHD112

10.1 Technical Data

Designation	Symbol	Unit	Data	
Motor type			MHD112A-024	MHD112A-058
Rated motor speed ¹⁾	n	min ⁻¹	2000	3500
Continuous torque at standstill ²⁾				
Cooling Natural convection method	M _{dN}	Nm	15.0	15.0
Continuous current at standstill				
Cooling Natural convection method	I _{dN}	A	13.1	17.1
Theoretical maximum torque ³⁾	M _{max}	Nm	54.0	54.0
Peak current	I _{max}	A	59.0	77.0
Rotor moment of inertia ⁴⁾	J _M	kgm ²	110 x 10 ⁻⁴	110 x 10 ⁻⁴
Torque constant at 20°C	K _m	Nm/A	1.28	0.98
Voltage constant at 20°C ⁵⁾	K _{Eeff}	V/1000 min ⁻¹	116.4	89.0
Windings resistance at 20°C	R _A	Ohm	1.45	0.86
Windings inductance	L _A	mH	14.0	7.8
Thermal time constant				
Cooling Natural convection method	T _{th}	min	90	90
Mass ⁴⁾	m _M	kg	23	23
Maximum installation elevation ⁷⁾		m	1000 meters above sea level	
Protection category ⁸⁾			IP 65	
Insulation class per DIN VDE 0530 section 1			F	
Housing coat			Basic black prime coat (RAL 9005)	
<p>1) Depending on torque requirements of the user. For standard applications see n_{max} in the selection lists of the motor/controller combination. For other applications, determine user speed using the required torque over the speed/torque characteristics.</p> <p>2) At 60 K overtemperature at the motor housing.</p> <p>3) The achievable maximum torque depends on the drive controller used. Only the maximum torque M_{max} for the motor/controller combinations found in the selection lists are binding.</p> <p>4) Without holding brake.</p> <p>5) At 1000 min⁻¹.</p> <p>6) For deviating ambient temperatures, see Section 3.1 .</p> <p>7) For deviating installation elevations, see Section 3.1 .</p> <p>8) Assuming correct mounting of power and feedback cables</p>				

Fig. 10-1: Technical data MHD112A

Designation		Symbol	Unit	Data			
Motor type				MHD112B-024	MHD112B-035	MHD112B-048	MHD112B-058
Rated motor speed ¹⁾		n	min ⁻¹	2000		3500	4000
Continuous torque at standstill ²⁾							
Cooling method	Natural convection	M _{dN}	Nm	28.0		28.0	28.0
	Surface cooling	M _{dN}	Nm	42.0		42.0	42.0
Continuous current at standstill							
Cooling method	Natural convection	I _{dN}	A	35.6		40.7	40.7
	Surface cooling	I _{dN}	A	53.4		61.1	61.1
Theoretical maximum torque ³⁾		M _{max}	Nm	102.0		102.0	102.0
Peak current		I _{max}	A	98.5		148.0	183.0
Rotor moment of inertia ⁴⁾		J _M	kgm ²	192 x 10 ⁻⁴		192 x 10 ⁻⁴	192 x 10 ⁻⁴
Torque constant at 20°C		K _m	Nm/A	1.43		0.88	0.77
Voltage constant at 20°C ⁵⁾		K _{Eeff}	V/1000 min ⁻¹	130.0		80.0	70.0
Windings resistance at 20°C		R _A	Ohm	0.58		0.37	0.17
Windings inductance		L _A	mH	7.6		4.8	2.2
Thermal time constant							
Cooling method	Natural convection	T _{th}	90	90		90	90
	Surface cooling	T _{th}	40	40		40	40
Mass ⁴⁾		m _M	kg	34.0		34.0	34.0
Allowed ambient temperature ⁶⁾		T _{um}	°C	0 to +45			
Allowed storage and transport temperature		T _L	°C	-20 to +80			
Maximum installation elevation ⁷⁾			m	1000 meters above sea level			
Protection category ⁸⁾				IP 65			
Insulation class per DIN VDE 0530 section 1				F			
Housing coat				Basic black prime coat (RAL 9005)			
<p>1) Depending on torque requirements of the user. For standard applications see n_{max} in the selection lists of the motor/controller combination. For other applications, determine user speed using the required torque over the speed/torque characteristics.</p> <p>2) At 60 K overtemperature at the motor housing.</p> <p>3) The achievable maximum torque depends on the drive controller used. Only the maximum torque M_{max} for the motor/controller combinations found in the selection lists are binding.</p> <p>4) Without holding brake.</p> <p>5) At 1000 min⁻¹.</p> <p>6) For deviating ambient temperatures, see Section 3.1 .</p> <p>7) For deviating installation elevations, see Section 3.1 .</p> <p>8) Assuming correct mounting of power and feedback cables.</p> <p>9) Without blower unit.</p>							

Fig. 10-2: Technical data MHD112B

Designation		Symbol	Unit	Data		
Motor type				MHD112C-024	MHD112C-035	MHD112C-058
Rated motor speed ¹⁾		n	min ⁻¹	2000	3000	4000
Continuous torque at standstill ²⁾						
Cooling method	Natural convection	M _{dN}	Nm	38.0	38.0	38.0
	Surface cooling	M _{dN}	Nm	57.0	57.0	57.0
Continuous current at standstill						
Cooling method	Natural convection	I _{dN}	A	26.6	31.0	53.2
	Surface cooling	I _{dN}	A	39.9	46.5	79.8
Theoretical maximum torque ³⁾		M _{max}	Nm	148.0	148.0	148.0
Peak current		I _{max}	A	120,0	139,5	239,0
Rotor moment of inertia ⁴⁾		J _M	kgm ²	273 x 10 ⁻⁴	273 x 10 ⁻⁴	273 x 10 ⁻⁴
Torque constant at 20°C		K _m	Nm/A	1.6	1.37	0.8
Voltage constant at 20°C ⁵⁾		K _{Eeff}	V/1000 min ⁻¹	145.5	119.1	72.2
Windings resistance at 20°C		R _A	Ohm	0.43	0.3	0.12
Windings inductance		L _A	mH	6.7	4.2	1.5
Thermal time constant						
Cooling method	Natural convection	T _{th}	90	90	90	90
	Surface cooling	T _{th}	40	40	40	40
Mass ⁴⁾		m _M	kg	45.0	45.0	45.0
Allowed ambient temperature ⁶⁾		T _{um}	°C	0 to +45		
Allowed storage and transport temperature		T _L	°C	-20 to +80		
Maximum installation elevation ⁷⁾			m	1000 meters above sea level		
Protection category ⁸⁾				IP 65		
Insulation class per DIN VDE 0530 section 1				F		
Housing coat				Basic black prime coat (RAL 9005)		

1) Depending on torque requirements of the user. For standard applications see n_{max} in the selection lists of the motor/controller combination. For other applications, determine user speed using the required torque over the speed/torque characteristics.
2) At 60 K overtemperature at the motor housing.
3) The achievable maximum torque depends on the drive controller used. **Only** the maximum torque M_{max} for the motor/controller combinations found in the selection lists are binding.
4) Without holding brake.
5) At 1000 min⁻¹.
6) For deviating ambient temperatures, see Section 3.1 .
7) For deviating installation elevations, see Section 3.1 .
8) Assuming correct mounting of power and feedback cables.
9) Without blower unit.

Fig. 10-3: Technical data MHD112C

Designation	Symbol	Unit	Data
Motor type			MHD112D-027
Rated motor speed ¹⁾	n	min ⁻¹	3000
Continuous torque at standstill ²⁾			
Cooling method Natural convection	M _{dN}	Nm	48.0
Surface cooling	M _{dN}	Nm	72.0
Continuous current at standstill			
Cooling method Natural convection	I _{dN}	A	31.6
Surface cooling	I _{dN}	A	47.4
Theoretical maximum torque ³⁾	M _{max}	Nm	187.0
Peak current	I _{max}	A	142.2
Rotor moment of inertia ⁴⁾	J _M	kgm ²	360 x 10 ⁻⁴
Torque constant at 20°C	K _m	Nm/A	1.7
Voltage constant at 20°C ⁵⁾	K _{Eeff}	V/1000 min ⁻¹	154.5
Windings resistance at 20°C	R _A	Ohm	0.35
Windings inductance	L _A	mH	5.7
Thermal time constant			
Cooling method Natural convection	T _{th}	min	90
Surface cooling	T _{th}	min	40
Mass ^{4) 9)}	m _M	kg	48.0
Allowed ambient temperature ⁶⁾	T _{um}	°C	0 to +45
Allowed storage and transport temperature	T _L	°C	-20 to +80
Maximum installation elevation ⁷⁾		m	1000 meters above sea level
Protection category ⁸⁾			IP 65
Insulation class per DIN VDE 0530 section 1			F
Housing coat			Basic black prime coat (RAL 9005)
<p>1) Depending on torque requirements of the user. For standard applications see n_{max} in the selection lists of the motor/controller combination. For other applications, determine user speed using the required torque over the speed/torque characteristics.</p> <p>2) At 60 K overtemperature at the motor housing.</p> <p>3) The achievable maximum torque depends on the drive controller used. Only the maximum torque M_{max} for the motor/controller combinations found in the selection lists are binding.</p> <p>4) Without holding brake.</p> <p>5) At 1000 min⁻¹.</p> <p>6) For deviating ambient temperatures, see Section 3.1.</p> <p>7) For deviating installation elevations, see Section 3.1.</p> <p>8) Assuming correct mounting of power and feedback cables.</p> <p>9) Without blower unit.</p>			

Fig. 10-4: Technical data MHD112D

Benennung	Symbol	Unit	Data holding brake	
Motor type			MHD112A MHD112B	MHD112C MHD112D
Holding torque	M_H	Nm	22	70
Rated voltage	U_N	V	DC 24 ±10%	DC 24 ±10%
Rated current	I_N	A	0.71	1.29
Moment of inertia	J_B	kgm ²	3.6×10^{-4}	30×10^{-4}
Link time	t_1	ms	25	53
Separating time	t_2	ms	50	97
Mass	m_B	kg	1.1	3.8

Fig. 10-5: Technical data holding brake (Option)

Designation	Symbol	Unit	Surface cooling data	
Rated voltage	U_N	V	1 x AC 230 ±10%	1 x AC 115 ±10%
Rated current	I_N	A	0.2	0.4
Power consumption	S_N	VA	40	39
Frequency	f	Hz	50	60

Fig. 10-6: Technical data surface cooling MHD112 (Option)

10.2 Speed/Torque Characteristics

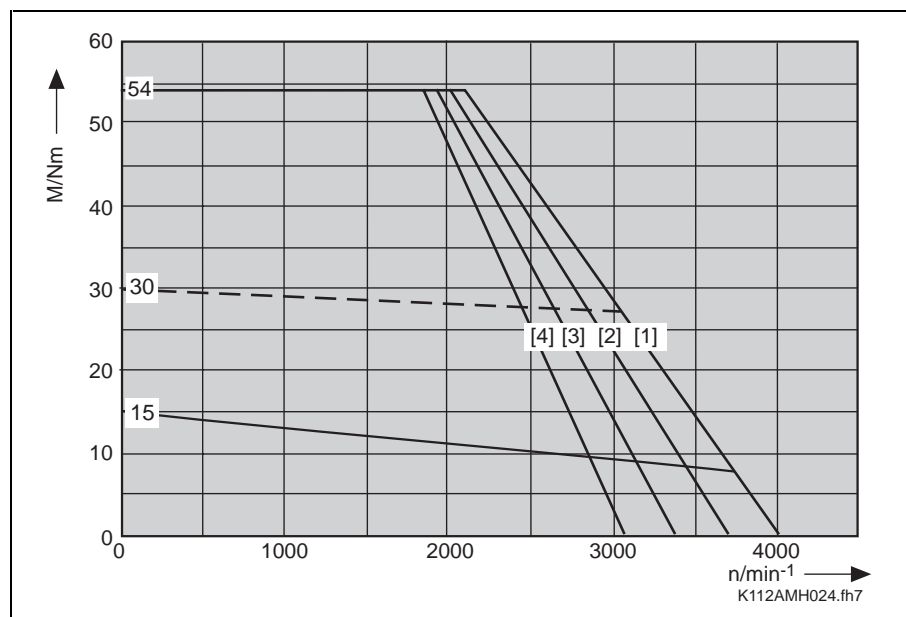

Fig. 10-7: Speed/torque characteristics MHD 112A-024

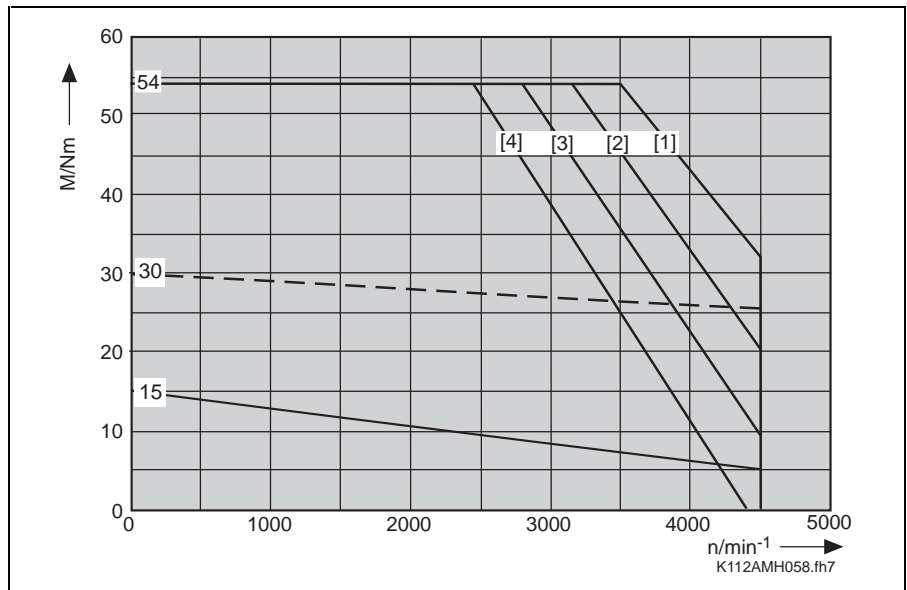

Fig. 10-8: Speed/torque characteristics MHD 112A-058

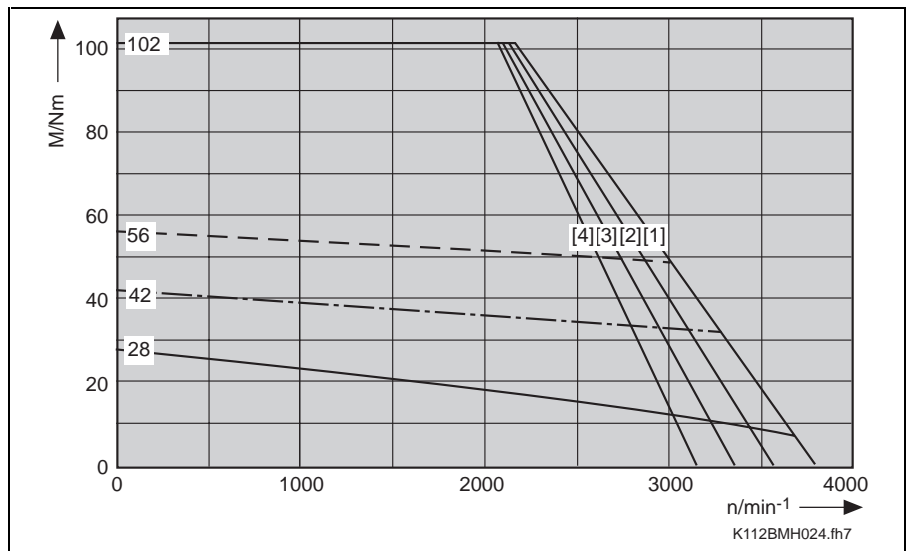

Fig. 10-9: Speed/torque characteristics MHD 112B-024

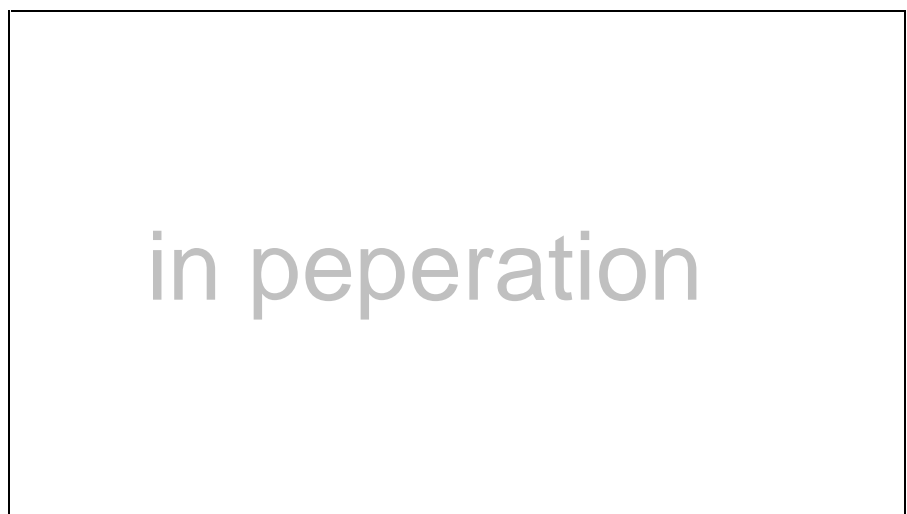

Fig. 10-10: Speed/torque characteristics MHD 112B-035

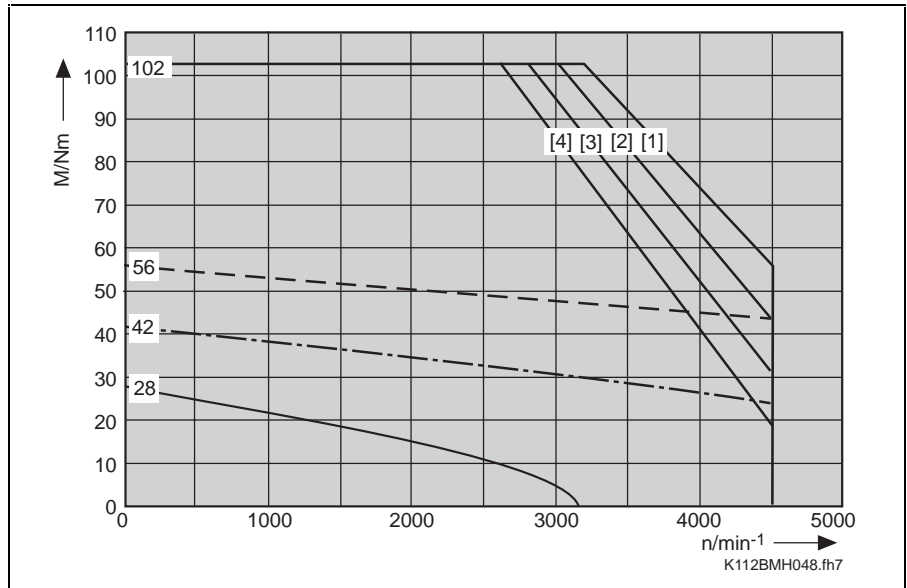

Fig. 10-11: Speed/torque characteristics MHD 112B-048

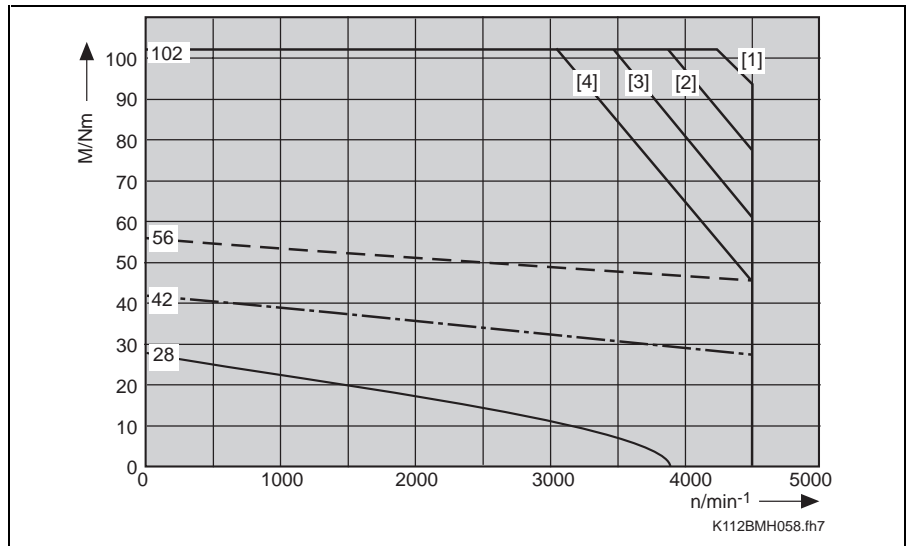

Fig. 10-12: Speed/torque characteristics MHD 112B-058

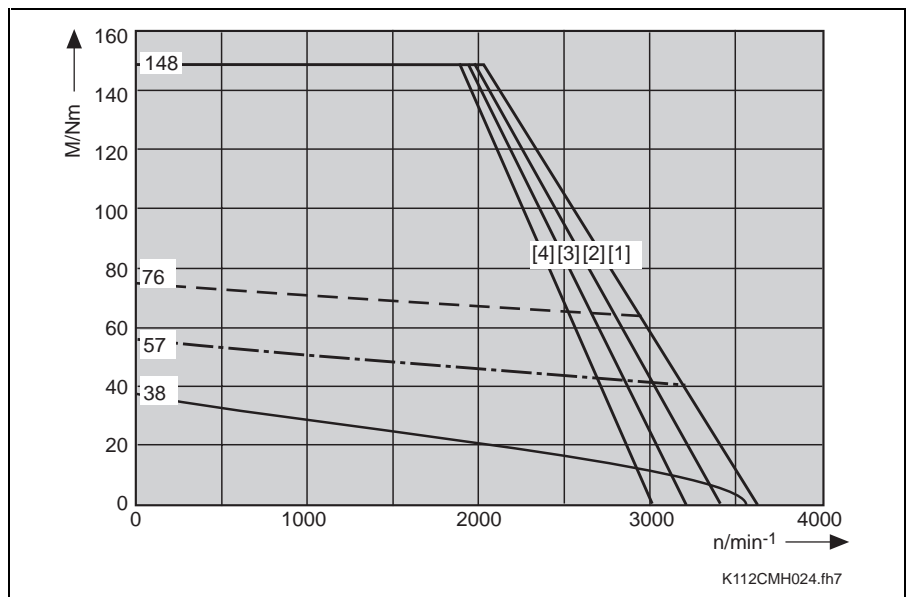

Fig. 10-13: Speed/torque characteristics MHD 112C-024

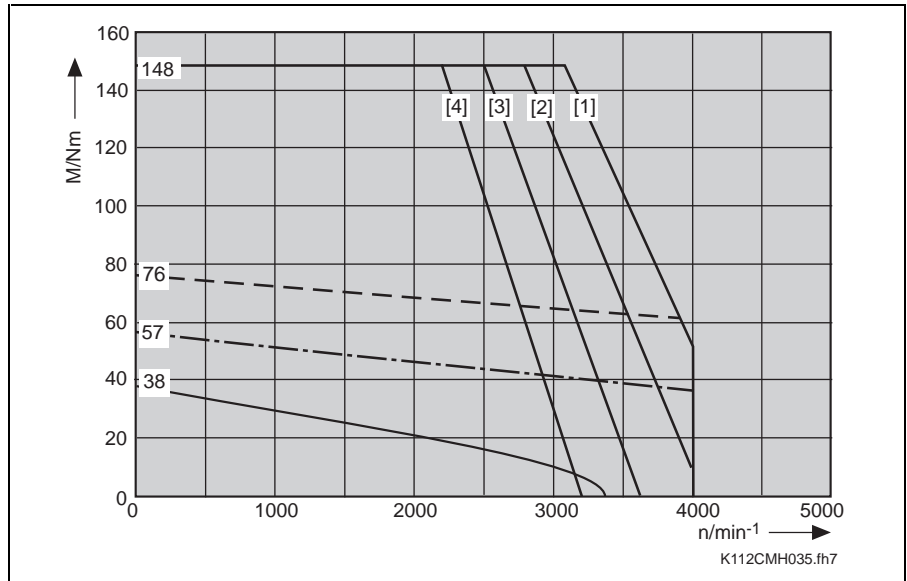

Fig. 10-14: Speed/torque characteristics MHD 112C-035

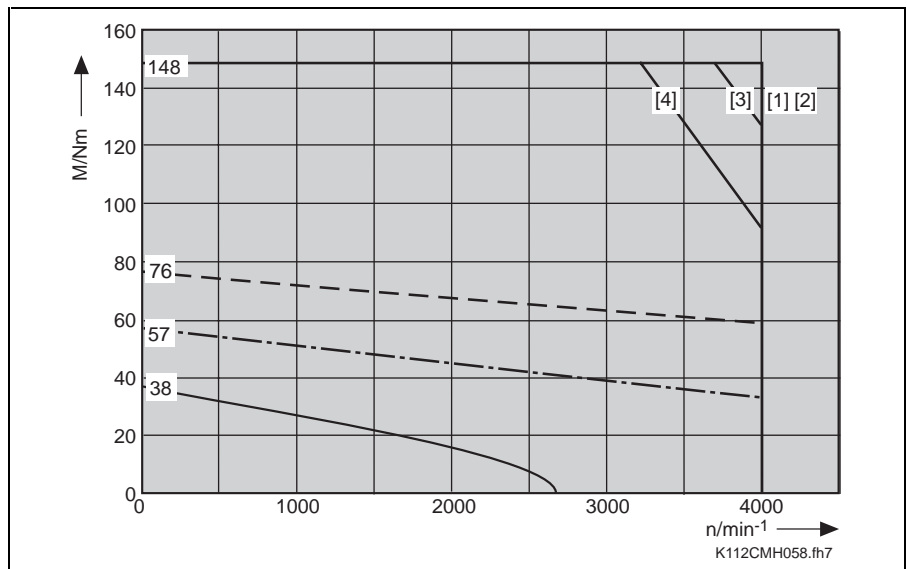

Fig. 10-15: Speed/torque characteristics MHD 112C-058

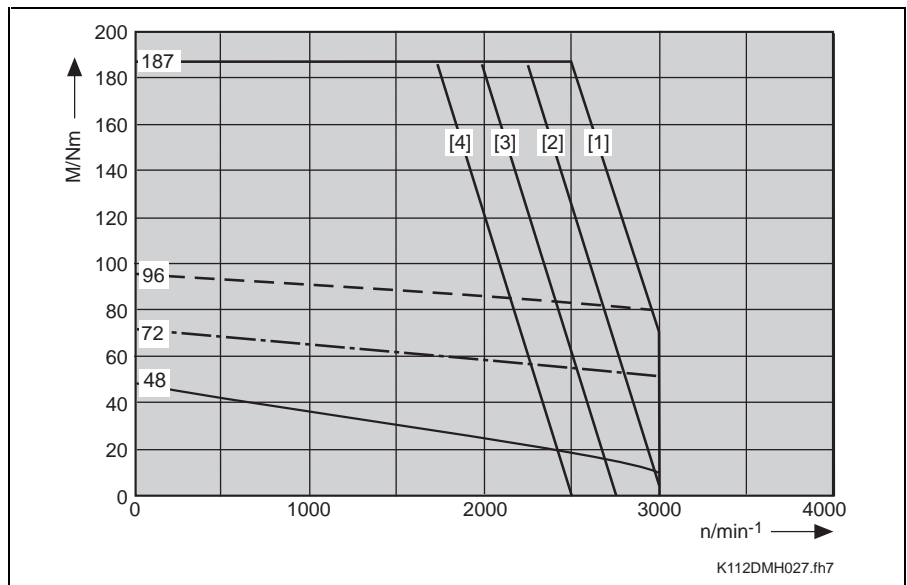

Fig. 10-16: Speed/torque characteristics MHD 112D-027

10.3 Data on Determining Maximum Shaft Load

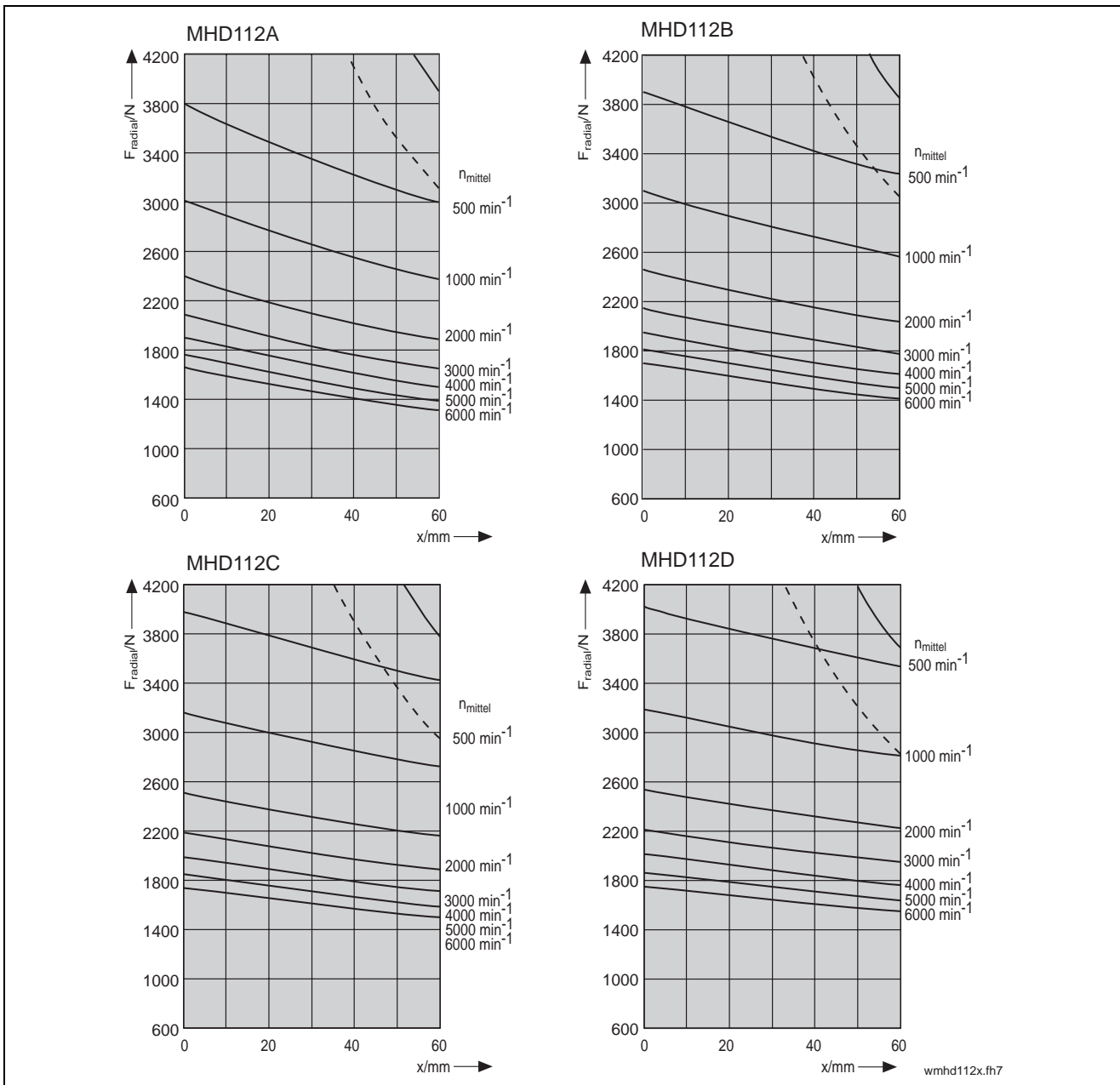

Fig. 10-17: MHD112: allowable maximum radial force F_{radial_max} and allowable radial force F_{radial}

Allowable axial force F_{axial}

$$F_{axial} = x \cdot F_{radial}$$

x : = 0.36 for MHD112A, MHD112B
 = 0.35 for MHD112C, MHD112D

F_{axial} : Allowable axial force in N

F_{radial} : allowable radial force in N

Fig. 10-18: MHD112: Allowable axial force F_{axial}

10.4 Dimensional Data

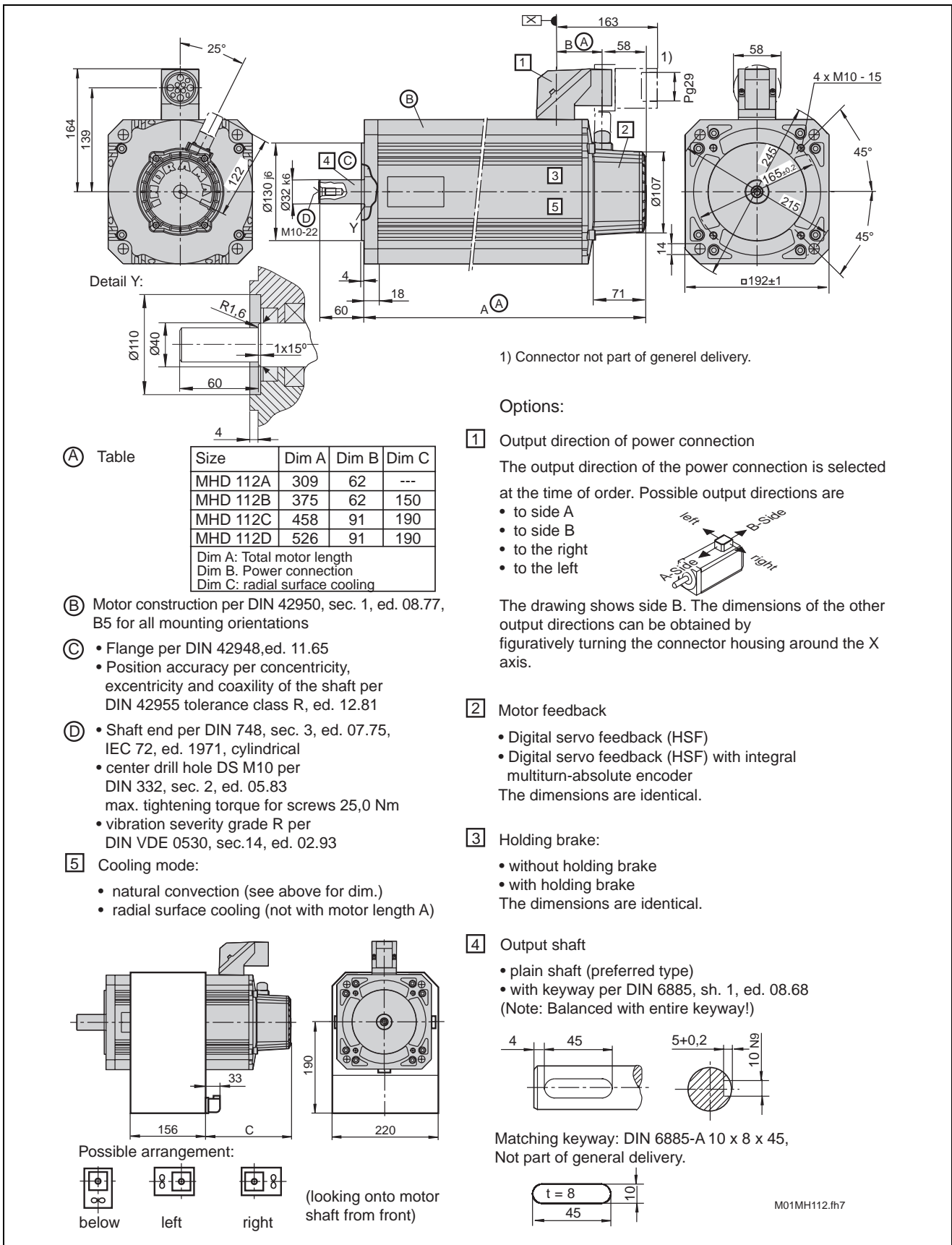

Fig. 10-19: Dimensional sheet - MHD112A-024, MHD112B-024, MHD112B-048, MHD112B-058, MHD112C-024, MHD112C-035, MHD112D-027

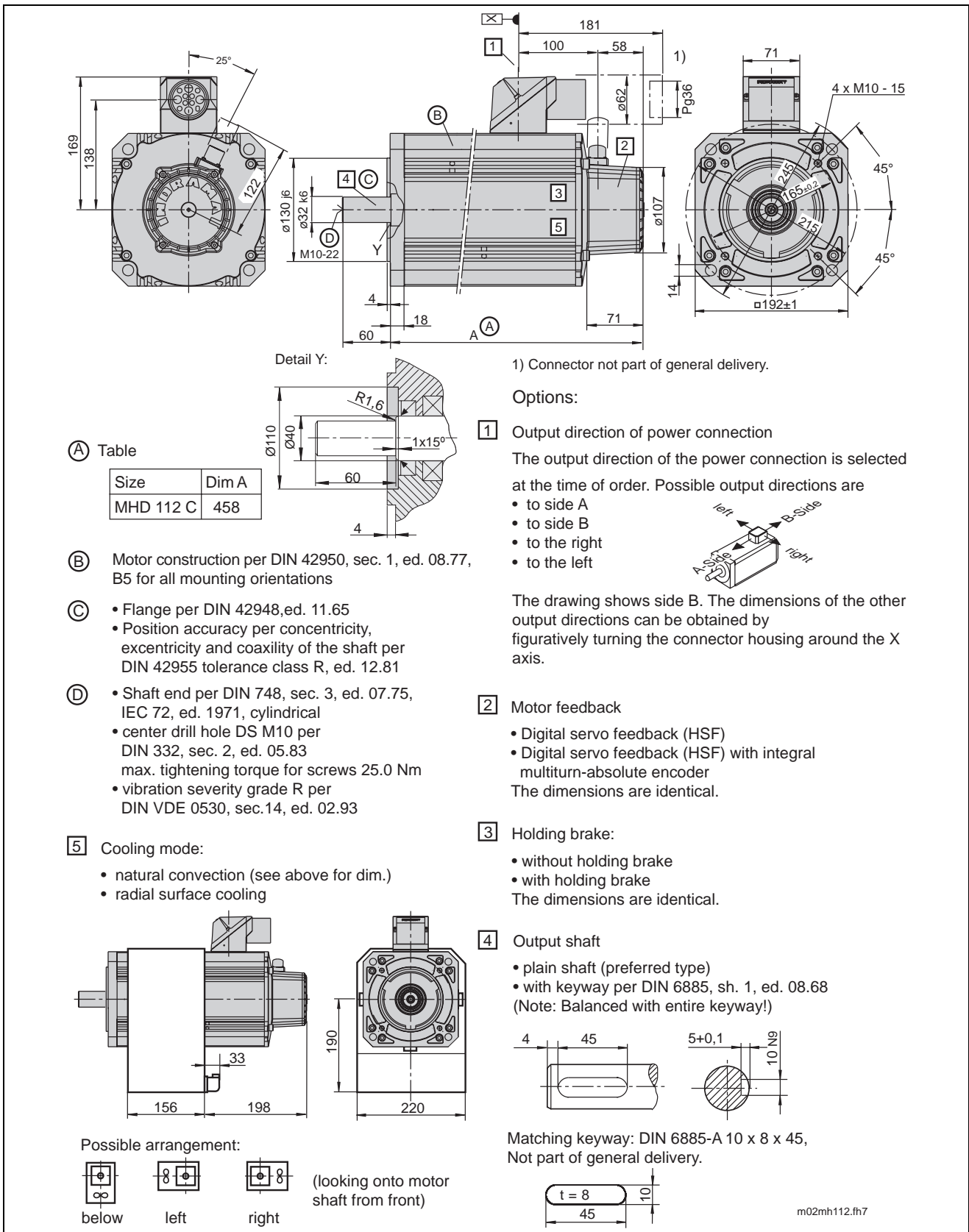

Fig. 10-20: Dimensional sheet - MHD112C-058

10.5 Available Versions and Type Codes

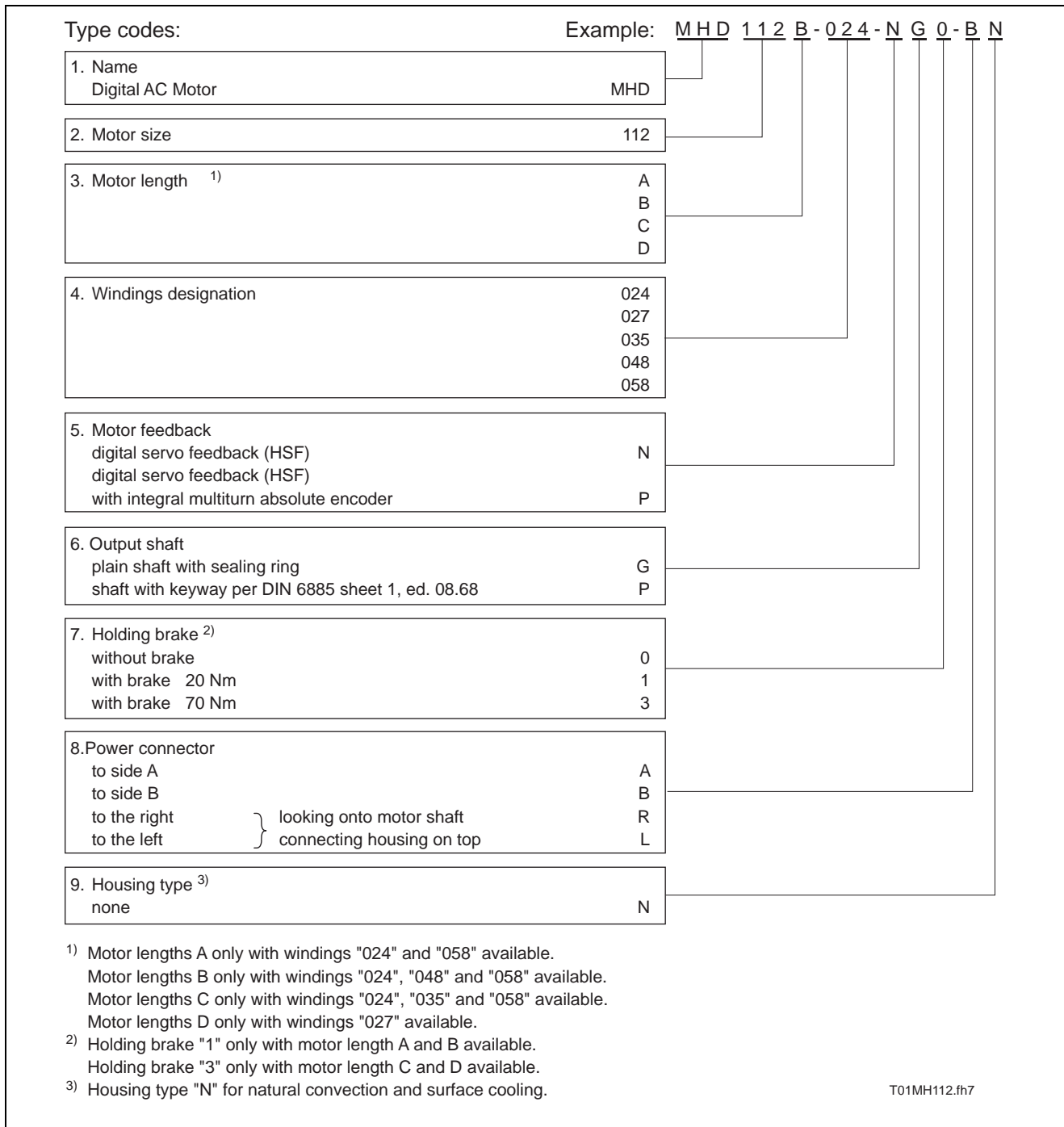

Fig. 10-21: Type Codes MHD 112

10.6 Surface cooling

Selection of blower unit

⇒ Selecting from following table the desired blower unit.

Motor type	Designation blower unit	
	AC 115V / 60Hz	AC 230V / 50Hz
MHD112A-...	---	---
MHD112B-...	LEM -RB112C2XX	LEM -RB112C1XX
MHD112C-...	LEM -RB112C2XX	LEM -RB112C1XX
MHD112D-...	LEM -RB112C2XX	LEM -RB112C1XX
--- blower unit not possible		

Fig. 10-22: Blower units MHD112

Motor with mounted blower unit

If you want to order a motor with mounted surface cooling then specify the above-referenced type designations of the radial blower unit as a subitem of the MHD motor with the desired blower arrangement.

Order position	Designation
1	1x digital AC motor MHD112B-024-NG0-BN
1.1	1x blower unit LEM -RB112C1-XX mounted to pos. 1 blower arrangement left

Fig. 10-23: Order information for MHD motor with mounted blower unit

Motor with separate blower unit

If the blower unit is listed as a separate order position, then it will be delivered separate of the motor (i.e., not mounted).

Order position	Designation
1	1x digital AC motor MHD112B-024-NG0-BN
2	1x blower unit LEM -RB112C1-XX

Fig. 10-24: Order information for MHD motor with separate blower unit

11 MHD115

11.1 Technical Data

Designation		Symbol	Unit	Data			
Motor type				MHD115A-024	MHD115A-058	MHD115B-024	MHD115B-058
Rated motor speed ¹⁾		n	min ⁻¹	2000	4000	2000	4000
Continuous torque at standstill ²⁾							
Cooling method	Natural convection	M _{dN}	Nm	32.0	32.0	50.0	50.0
	Surface cooling	M _{dN}	Nm	---	---	75.0	75.0
	liquid cooled	M _{dN}	Nm	60.8	60.8	95.0	95.0
Continuous current at standstill							
Cooling method	Natural convection	I _{dN}	A	21.7	36.6	32.3	62.2
	Surface cooling	I _{dN}	A	---	---	48.5	93.8
	liquid cooled	I _{dN}	A	41.2	69.5	61.4	118.8
Theoretical maximum torque ³⁾		M _{max}	Nm	110.0	110.0	160.0	160.0
Peak current		I _{max}	A	98.	164.7	145.0	280.0
Rotor moment of inertia ⁴⁾		J _M	kgm ²	65,0 x 10 ⁻⁴	65,0 x 10 ⁻⁴	93,2 x 10 ⁻⁴	93,2 x 10 ⁻⁴
Torque constant at 20°C		K _m	Nm/A	1.65	0.98	1.7	0.9
Voltage constant at 20°C ⁵⁾		K _{Eeff}	V/1000 min ⁻¹	150.0	89.1	154.0	81.8
Windings resistance at 20°C		R _A	Ohm	0.66	0.21	0.36	0.11
Windings inductance		L _A	mH	8.6	2.88	5.3	1.6
Thermal time constant							
Cooling method	Natural convection	T _{th}	min	60	60	100	100
	Surface cooling	T _{th}	min	---	---	45	45
	liquid cooled	T _{th}	min	20	20	30	30
Mass ^{4) 9)}		m _M	kg	30.0	30.0	40.0	40.0
Allowed ambient temperature ⁶⁾		T _{um}	°C	0 to +45			
Allowed storage and transport temperature		T _L	°C	-20 to +80			
Maximum installation elevation ⁷⁾			m	1000 meters above sea level			
Protection category ⁸⁾				IP 65			
Insulation class per DIN VDE 0530 section 1				F			
Housing coat				Basic black prime coat (RAL 9005)			

1) Depending on torque requirements of the user. For standard applications see n_{max} in the selection lists of the motor/controller combination. For other applications, determine user speed using the required torque over the speed/torque characteristics.
2) At 60 K overtemperature at the motor housing.
3) The achievable maximum torque depends on the drive controller used. **Only** the maximum torque M_{max} for the motor/controller combinations found in the selection lists are binding.
4) Without holding brake.
5) At 1000 min⁻¹.
6) For deviating ambient temperatures, see Section 3-1.
7) For deviating installation elevations, see Section 3-1.
8) Assuming correct mounting of power and feedback cables.
9) Without blower unit.

Fig. 11-1: Technical data MHD115B and MHD115C

Designation		Symbol	Unit	Data	
Motor type				MHD115C-024	MHD115C-058
Rated motor speed ¹⁾		n	min ⁻¹	2000	4000
Continuous torque at standstill ²⁾					
Cooling method	Natural convection	M _{dN}	Nm	70.0	70.0
	Surface cooling	M _{dN}	Nm	105.0	105.0
	liquid cooled	M _{dN}	Nm	133.0	133.0
Continuous current at standstill					
Cooling method	Natural convection	I _{dN}	A	47.5	82.5
	Surface cooling	I _{dN}	A	71.3	123.8
	liquid cooled	I _{dN}	A	90.3	156.8
Theoretical maximum torque ³⁾		M _{max}	Nm	231.0	231.0
Peak current		I _{max}	A	214.0	371.0
Rotor moment of inertia ⁴⁾		J _M	kgm ²	138 x 10 ⁻⁴	138 x 10 ⁻⁴
Torque constant at 20°C		K _m	Nm/A	1.65	0.95
Voltage constant at 20°C ⁵⁾		K _{Eeff}	V/1000 min ⁻¹	150.0	86.4
Windings resistance at 20°C		R _A	Ohm	0.185	0.06
Windings inductance		L _A	mH	3.0	0.9
Thermal time constant					
Cooling method	Natural convection	T _{th}	min	100	100
	Surface cooling	T _{th}	min	45	45
	liquid cooled	T _{th}	min	30	30
Mass ^{4) 9)}		m _M	kg	55	55
Allowed ambient temperature ⁶⁾		T _{um}	°C	0 to +45	
Allowed storage and transport temperature		T _L	°C	-20 to +80	
Maximum installation elevation ⁷⁾			m	1000 meters above sea level	
Protection category ⁸⁾				IP 65	
Insulation class per DIN VDE 0530 section 1				F	
Housing coat				Basic black prime coat (RAL 9005)	
<p>1) Depending on torque requirements of the user. For standard applications see n_{max} in the selection lists of the motor/controller combination. For other applications, determine user speed using the required torque over the speed/torque characteristics.</p> <p>2) At 60 K overtemperature at the motor housing.</p> <p>3) The achievable maximum torque depends on the drive controller used. Only the maximum torque M_{max} for the motor/controller combinations found in the selection lists are binding.</p> <p>4) Without holding brake.</p> <p>5) At 1000 min⁻¹.</p> <p>6) For deviating ambient temperatures, see Section 3.1 .</p> <p>7) For deviating installation elevations, see Section 3.1 .</p> <p>8) Assuming correct mounting of power and feedback cables.</p> <p>9) Without blower unit.</p>					

Fig. 11-2: Technical data MHD115C

Designation	Symbol	Unit	Data holding brake
Motor type			MHD115A MHD115B MHD115C
Holding torque	M_H	Nm	70
Rated voltage	U_N	V	DC 24 \pm 10%
Rated current	I_N	A	1,29
Moment of inertia	J_B	kgm ²	30×10^{-4}
Link time	t_1	ms	53
Separating time	t_2	ms	97
Mass	m_B	kg	3,8

Fig. 11-3: Technical data holding brake MHD115 (Option)

Designation	Symbol	Unit	Data		
Motor type			MHD115A	MHD115B	MHD115C
Rated power loss	P_{VN}	W	1100	1200	1300
Entry temperature of coolant ¹⁾	ϑ_{ein}	°C	+10 ... +40		
Increase in coolant temperature with P_{VN}	$\Delta\vartheta_N$	°C	10		
Minimum required coolant flowthrough at $\Delta\vartheta_N$ ²⁾	Q_N	l/min	1.5	1.7	1.8
Pressure drop with Q_N ²⁾³⁾	Δp_N	bar	0.8	0.9	1.0
Maximum system pressure	p_{max}	bar	3.0		
Coolant channel volume	V	l	in prep.	in prep.	in prep.
1) Note relationship between entry temp. of coolant and act. ambient temp.: entry temp. max not exceed 5°C below actual ambient temperature (otherwise danger of condensation!) 2) if coolant is water 3) for deviating flowthrough values of flow diagram (see Section "5").					

Fig. 11-4: Technical data liquid cooling MHD115

Designation	Symbol	Unit	Surface cooling data	
Rated voltage	U_N	V	1 x AC 230 \pm 10%	1 x AC 115 \pm 10%
Rated current	I_N	A	0,2	0,4
Power consumption	S_N	VA	40	39
Frequency	f	Hz	50	60

Fig. 11-5: Technical data surface cooling MHD115 (Option)

11.2 Speed/Torque Characteristics

For details see Section 3.11 Speed/Torque Characteristics .

See next page...

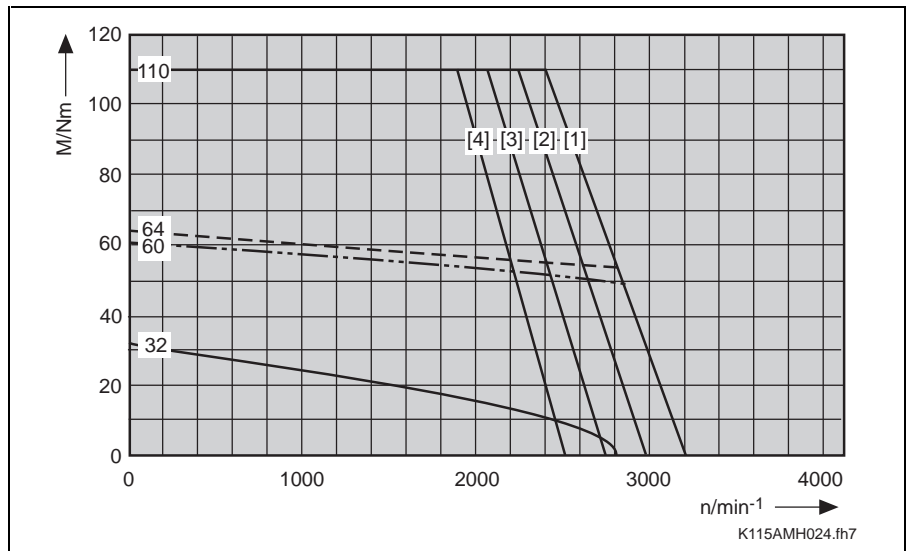

Fig. 11-6: Speed/torque characteristics MHD115A-024

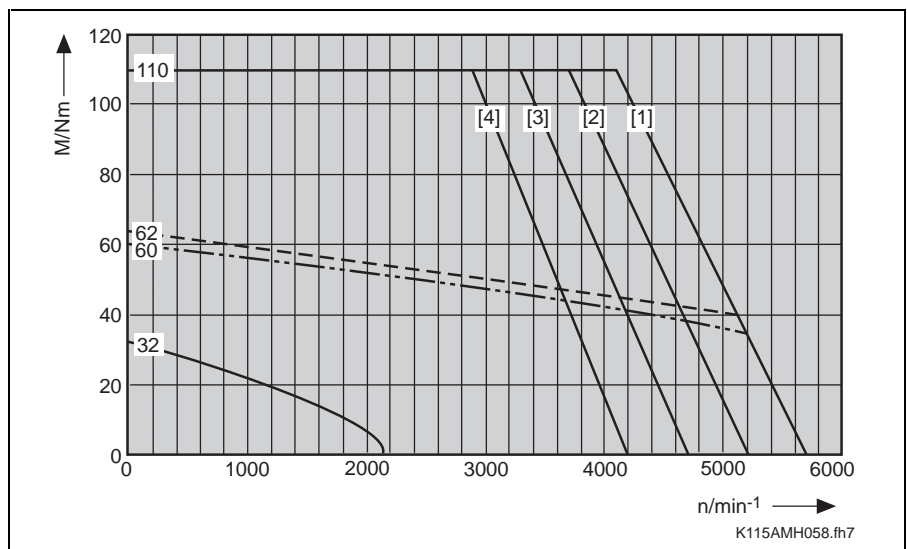

Fig. 11-7: Speed/torque characteristics MHD115A-058

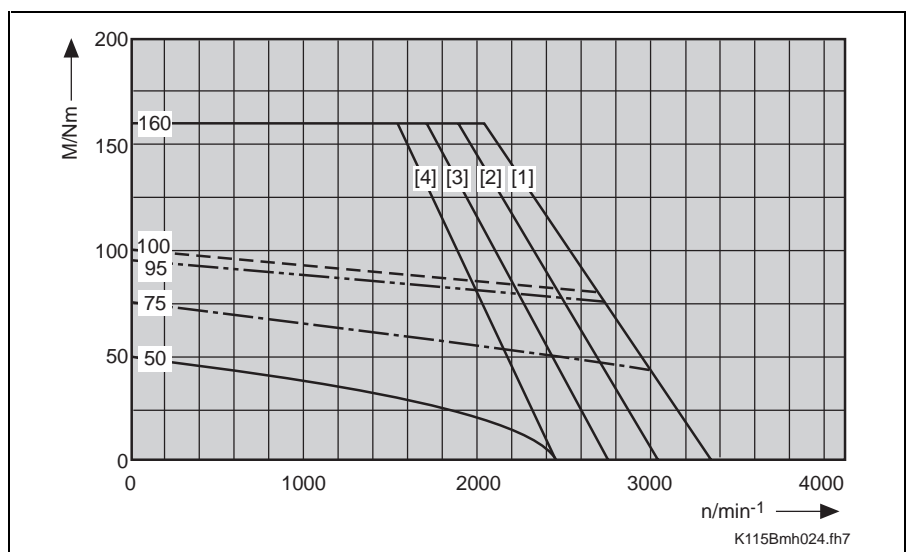

Fig. 11-8: Speed/torque characteristics MHD115B-024

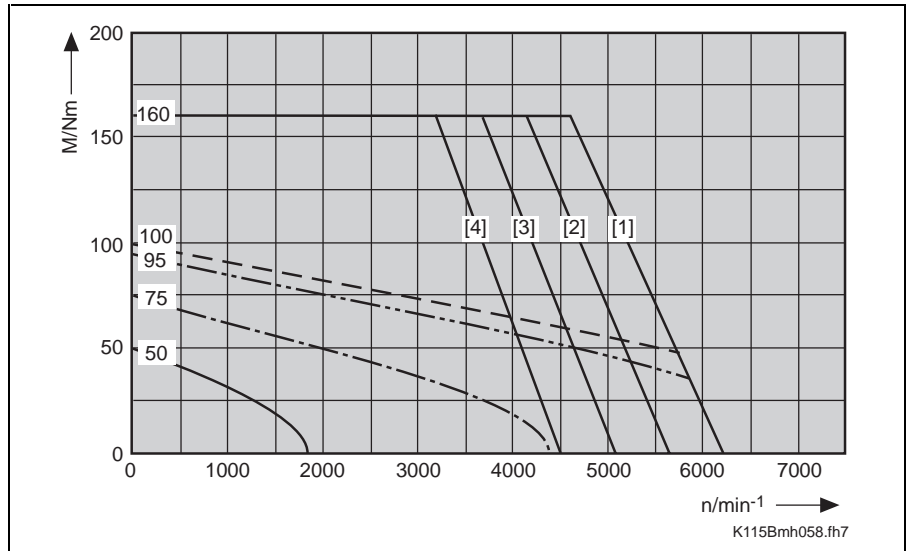

Fig. 11-9: Speed/torque characteristics MHD115B-058

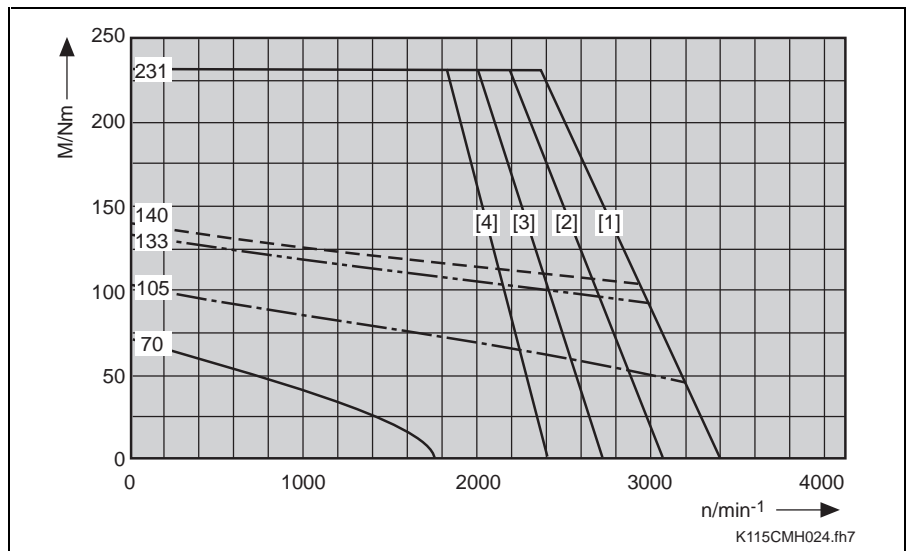

Fig. 11-10: Speed/torque characteristics MHD115C-024

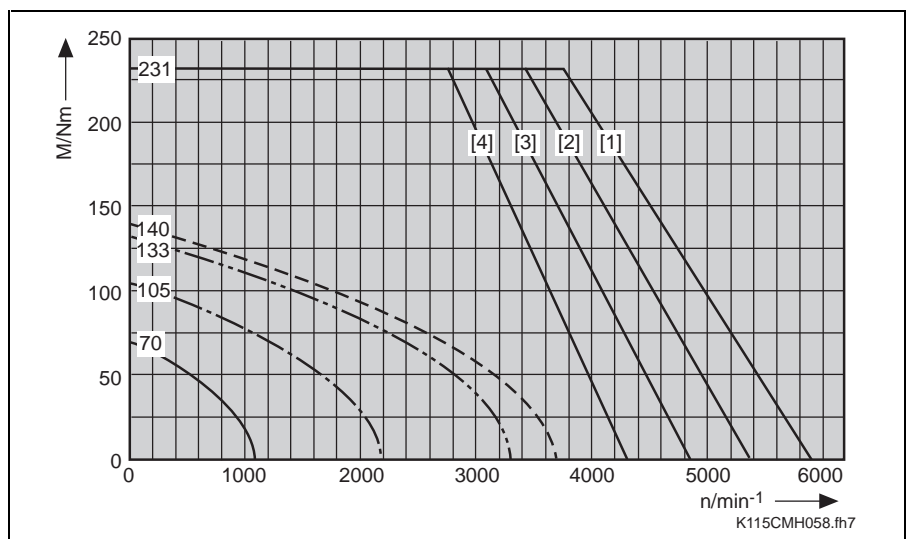

Fig. 11-11: Speed/torque characteristics MHD115C-058

11.3 Data for Determining Maximum Shaft Load

Allowable maximum radial force $F_{\text{radial_max}}$ and allowable radial force F_{radial} For details see Section 3.6 Output Shafts .

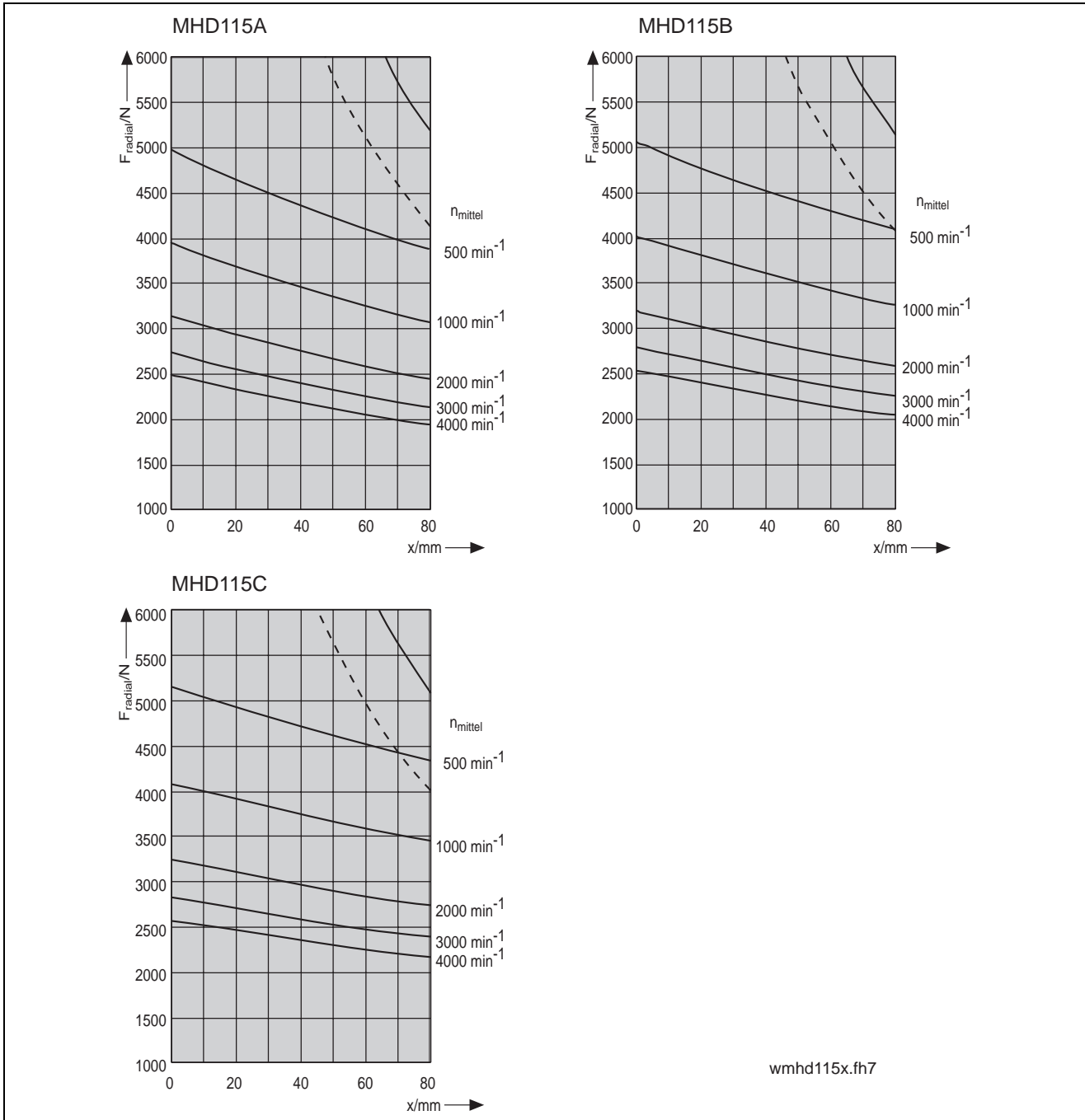

Fig. 11-12: MHD115: allowable maximum radial force $F_{\text{radial_max}}$ and allowable radial force F_{radial}

Allowable axial force F_{axial}

$$F_{\text{axial}} = 0,26 \cdot F_{\text{radial}}$$

F_{axial} : Allowable axial force in N
 F_{radial} : allowable radial force in N

Fig. 11-13: MHD115: Allowable axial force F_{axial}

11.4 Dimensional Data

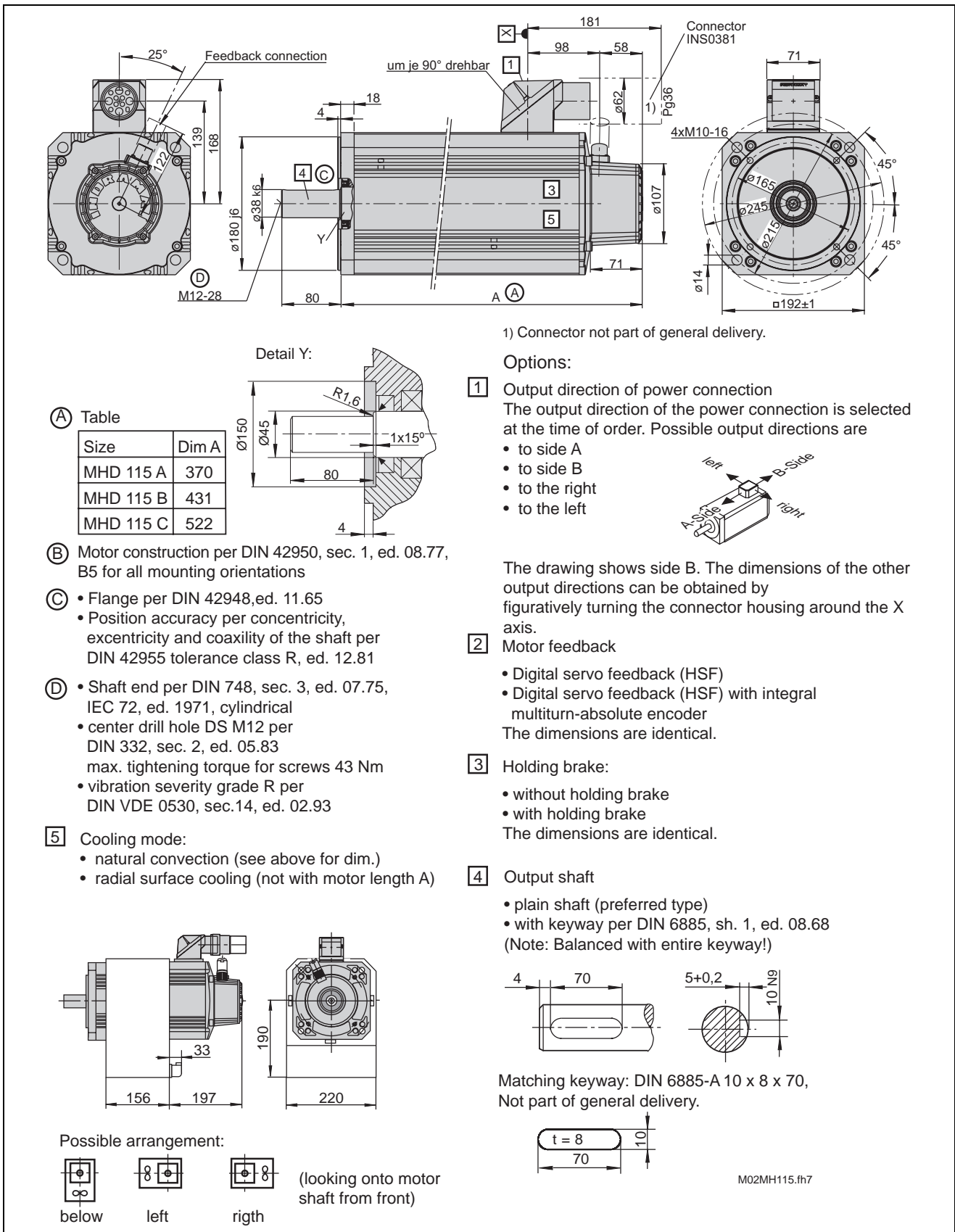
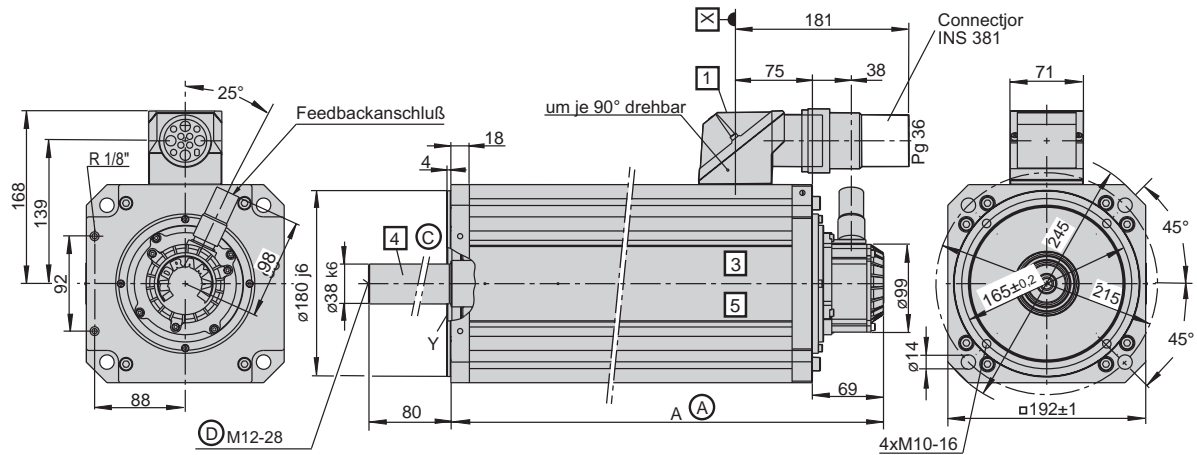
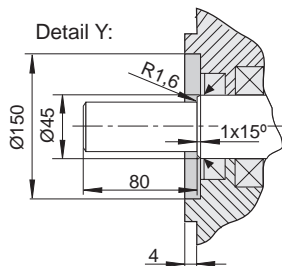

Fig. 11-14: Dimensional sheet - MHD115-...-...-A



1) Connector not part of general delivery



A Table

Size	Dim A
MHD 115 A	359
MHD 115 B	420
MHD 115 C	511

B Motor construction per DIN 42950, sec. 1, ed. 08.77, B5 for all mounting orientations

C

- Flange per DIN 42948, ed. 11.65
- Position accuracy per concentricity, excentricity and coaxility of the shaft per DIN 42955 tolerance class R, ed. 12.81

D

- Shaft end per DIN 748, sec. 3, ed. 07.75, IEC 72, ed. 1971, cylindrical
- center drill hole DS M12 per DIN 332, sec. 2, ed. 05.83
- max. tightening torque for screws 43 Nm
- vibration severity grade R per DIN VDE 0530, sec.14, ed. 02.93

5 Cooling mode:

- natural convection (see above for dim.)
- liquid cooling (see above for dim.)

Optionen:

- 1** Output direction of power connection
The output direction of the power connection is selected at the time of order. Possible output directions are
- to side A
 - to side B
 - to the right
 - to the left

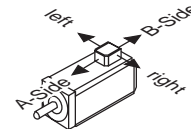

The drawing shows side B. The dimensions of the other output directions can be obtained by figuratively turning the connector housing around the X axis.

- 2** Motor feedback
- Digital servo feedback (HSF)
 - Digital servo feedback (HSF) with integral multiturn-absolute encoder
- The dimensions are identical.

- 3** Holding brake:
- without holding brake
 - with holding brake
- The dimensions are identical.

- 4** Output shaft
- plain shaft (preferred type)
 - with keyway per DIN 6885, sh. 1, ed. 08.68 (Note: Balanced with entire keyway!)

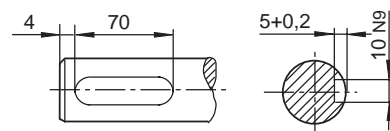

Matching keyway: DIN 6885-A 10 x 8 x 70, Not part of general delivery.

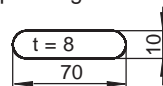

M01MH115.fh7

Fig. 11-15: Dimensional sheet - MHD115-...-...-N

11.5 Available Versions and Type Codes

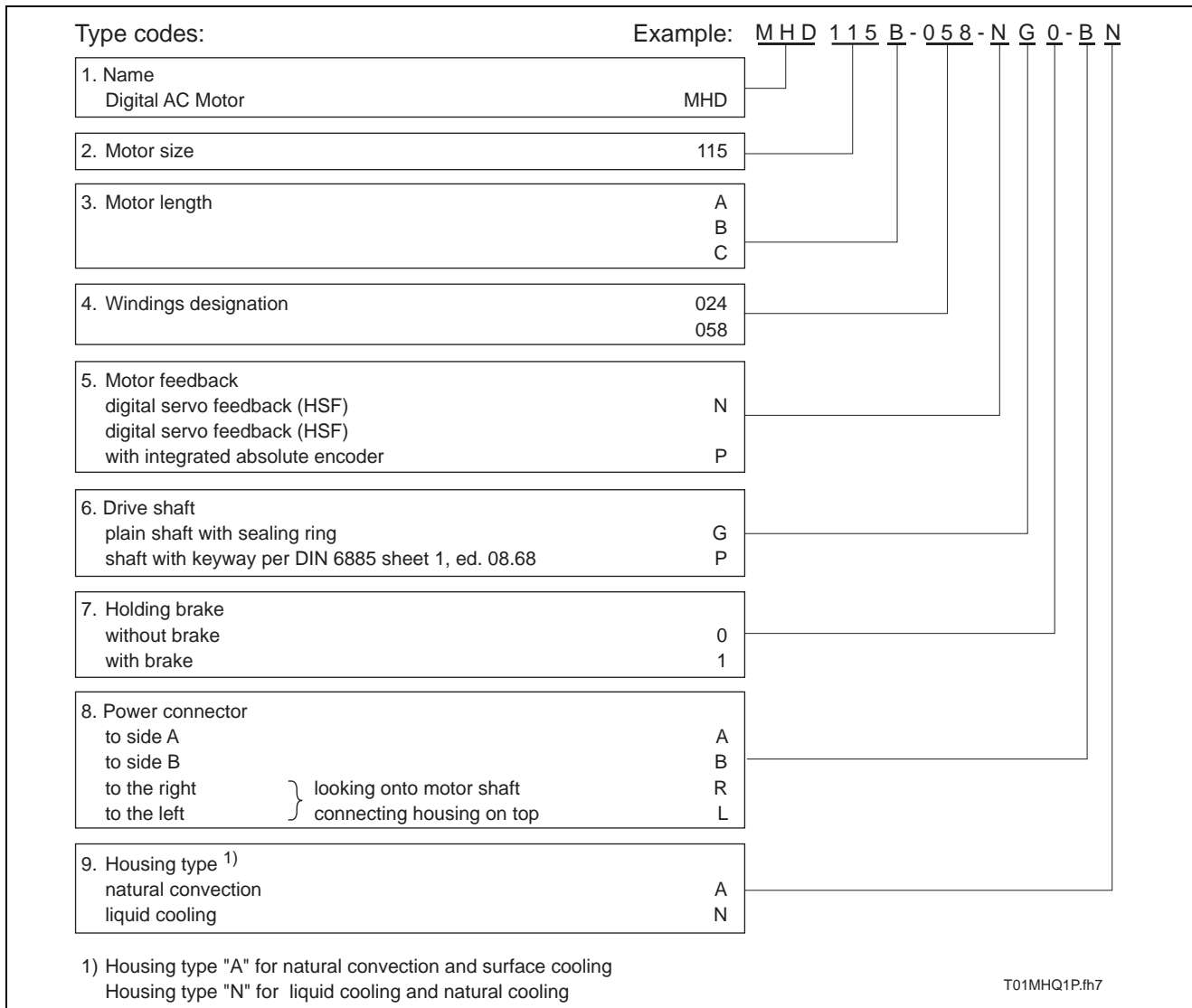

Fig. 11-16: Type Codes MHD115

11.6 Surface cooling

Selection of blower unit

⇒ Selecting from following table the desired blower unit.

Motor type	Designation blower unit	
	AC 115V / 60Hz	AC 230V / 50Hz
MHD115A-...	---	---
MHD115B-...	LEM-RB112C2XX	LEM-RB112C1XX
MHD115C-...	LEM-RB112C2XX	LEM-RB112C1XX
--- Blower unit not possible!		

Fig. 11-17: Blower units MHD115

Motor with mounted blower unit

If you want to order a motor with mounted surface cooling then specify the above-referenced type designations of the radial blower unit as a subitem of the MHD motor with the desired blower arrangement.

Order position	Designation
1	1 x digital AC- motor MHD115B-024-NG0-BN
1.1	1 x blower unit LEM -RB112C1XX mounted to pos. 1 blower arrangement left

Fig. 11-18: Order information for MHD motor with mounted blower unit

Motor with separate blower unit

If the blower unit is listed as a separate order position, then it will be delivered separate of the motor (i.e., not mounted).

Bestellposition	Bezeichnung
1	1 x digital AC- motor MHD115B-024-NG0-BN
2	1 x blower unit LEM -RB112C1XX

Fig. 11-19: Order information for MHD motor with separate blower unit

12 State at Delivery

12.1 General Information

The motors and their accessories such as cables are packaged in cartons. Depending on the number or size of the cartons, these are mounted to pallets and fastened with taut metal bands. Cartons are also pulled over the pallets to protect against adverse weather and these are also kept in place by bands.

12.2 Releasing the Taut Bands



There are uncontrolled motions of the taut bands when released!

Mechanical injuries are possible.

⇒ Carefully release the bands!

⇒ Maintain sufficient distance!

12.3 Documentation

The entire delivery is accompanied by only one envelope containing the delivery documentation. It lists the merchandise by name and order designation. If the listed contents are divided over several cartons (transport containers), then such is noted on the delivery slip or freight papers.

The packaging lists the following information:

- type designation of motor
- customer
- delivery slip number
- consignment
- freight company

(See also Section 13 Identifying the Merchandise)

13 Identifying the Merchandise

13.1 Delivery Slip

The entire delivery is accompanied by only one envelope containing the delivery slip. It lists the merchandise by name and order designation. If the listed contents are divided over several cartons (transport containers), then such is noted on the delivery slip or freight papers.

13.2 Barcode Sticker

There is a barcode sticker on every package containing a motor which lists the following:

- type designation of the motor
- customer
- delivery slip number
- consignment
- freight company

The barcode sticker is intended to help identify the contents at the time of order processing.

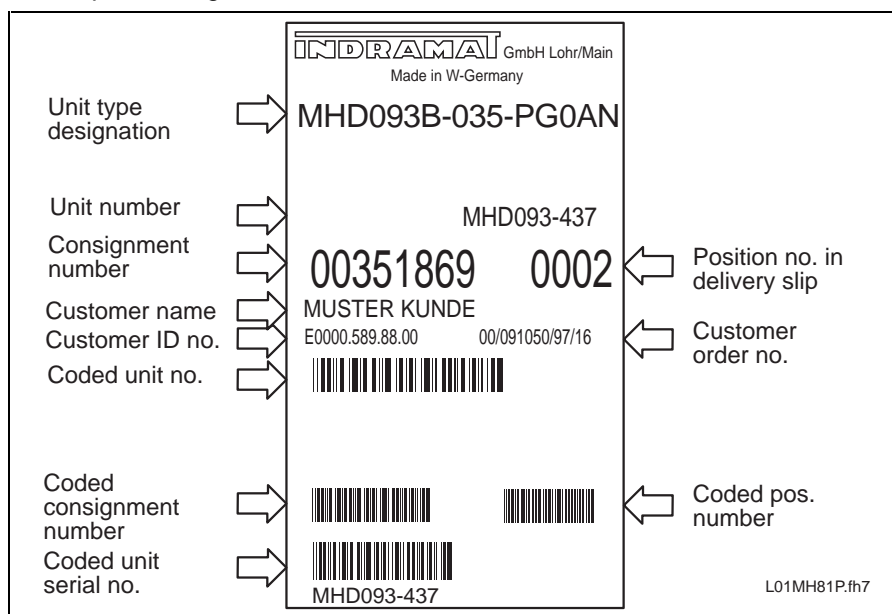

Fig. 13-1: Barcode sticker (Example)

13.3 Type Plates

Motors There is a type plate on the motor at the time of delivery. It is mounted to the housing. There is a second type plate taped to the housing. It can be situated in some highly visible spot on the motor if the original type plate is somehow hidden by the contours of the machine.

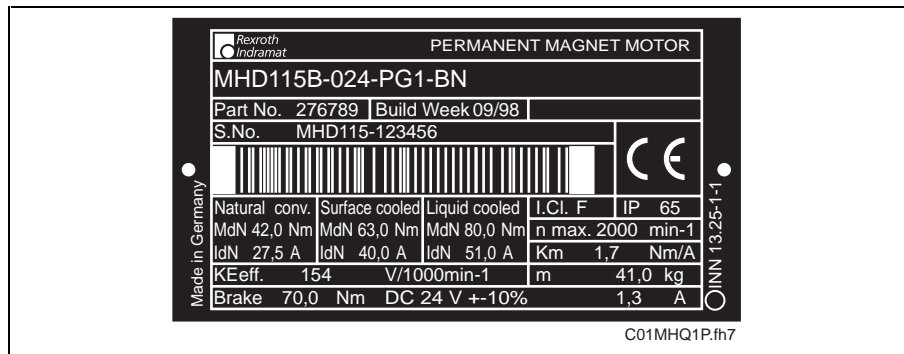

Fig. 13-2: Type plate (Example)

The type plate helps

- identify the motor
- find replacmenet parts if needed
- and lists service information

Blower unit There is a type plate on the blower unit. It is glued to the blower unit housing and protected with a foil. It lists type designation, serial numer and information on electrical connections.

Non-ready made cables Order numbers printed on cable sheath.

Individual plug-in connectors Type designations on plastic bags.

Ready-made cables Label (at cable end) with type designation.

14 Storage, Transport and Handling

14.1 Notes on Packaging

The packaging lists guidelines on storage, transport and handling the items. These must be complied with.

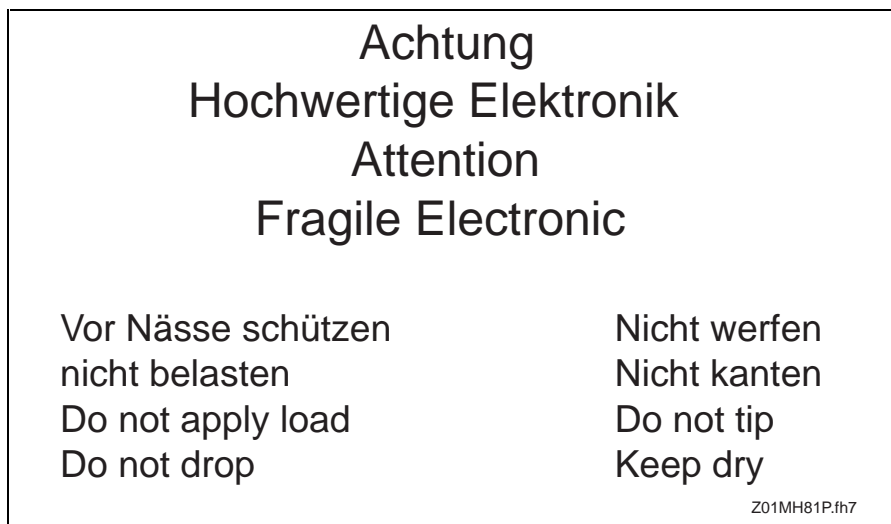

Fig. 14-1: Notes on storage, transport and handling on the packaging

14.2 Storage

Note Motor damage and loss of guarantee are possible!
Improper storage can damage the motor. The guarantee is also forfeited! Please therefore note the following instructions.

Maintain the following conditions during storage:

- ⇒ Allowable temperature range: -20° C to +80° C.
- ⇒ Motors must be stored dry, dust and shock free.
- ⇒ Motors must be stored in a horizontal position.
- ⇒ Protective sleeves of plastic are on the connector housing and the output shaft. Do not remove them. They protect against moisture and mechanical damage.
- ⇒ If liquid cooled motors have been in use, then empty all of the coolant out of the motor. Otherwise it could freeze over and damage the cooling channels.

14.3 Transport and Handling

Note Motor damage and loss of guarantee are possible!
Improper storage can damage the motor. The guarantee is also forfeited! Please therefore note the following instructions.

Maintain the following conditions during transport and when handling:

- ⇒ Use a suitable means of transport. Take weight of components into account (all weights listed in the individual sections of the motors in the technical data or on the type plate of the motors).
- ⇒ Use shock absorbers if shocks could occur during transport. Note the limit data as listed in Section 3.5 „Maximum Vibrations and Shock demands“ in this case.
- ⇒ Transport in horizontal position only.
- ⇒ Do not pick up motor by the surface cooling unit.
- ⇒ Use cranes with lifting belts when lifting motors.
- ⇒ M8 ring screws (DIN580) can be inserted into the tapped holes of MHD115 motors on the motor housing and used when lifting the machine with chain tackle.
- ⇒ Motor flange and output shaft should not be damaged!
- ⇒ Do not hit the output shaft.
- ⇒ Protective plastic sleeves on the connector housing and the output shaft should not be removed until shortly before mounting the motor.

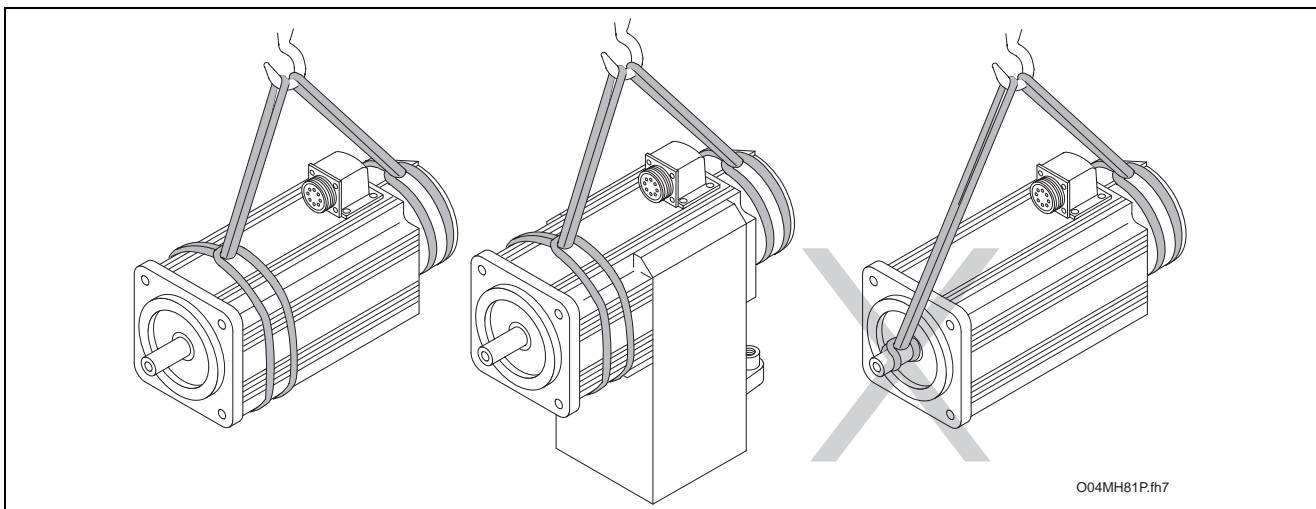

Fig. 14-2: Lifting and transporting with loop belts

15 Mounting and Installation

15.1 General Information on Mounting

- ⇒ Note all the warnings and safety instructions listed in section 2 Safety Instructions for Electrical Drives. This will minimize the risk of accidents and avoid damage to installation and motor.
- ⇒ Conduct each step carefully. This ensures a trouble-free mounting and removal of the components.

15.2 Mounting the Motor

- ⇒ Have handy all tools, instructions, measuring and testing devices.
- ⇒ Check components for cleanliness.
- ⇒ Check whether the components are visibly damaged. Do not mount damaged parts.
- ⇒ Make sure that the mounting procedure takes place in a dry, dust free environment.
- ⇒ Make sure that the motor flange is burr free.
- ⇒ Mount the motor. Maintain all the dimensions and tolerances of the installation. Relevant data is listed in section "MHD ...", "Dimensional Data".
- ⇒ If it is a liquid cooled motor, then establish the connections and check their density by pressing them with 5 bar. Also make sure that the flowthrough amount is correct.

15.3 Connecting the Motor

Once the motor is mechanically integrated, it can be connected.



Danger to life due to electrical voltage!

Handling the voltage-conducting sections can be dangerous to life. Therefore:

- ⇒ Work on the electrical aspects of the installation may only be conducted by trained personnel. Appropriate tools are absolutely necessary.
- ⇒ Prior to working, shut power to installation off and secure mains switch against unintentional or accidental switching back on.
- ⇒ Prior to starting work, check whether there is any residual voltage in the installation (e.g., due to capacitors and such). Wait until these have discharged.

**WARNING****Personnel injury or property damage possible!**

Interrupting or linking voltage-conductive lines can lead to dangerous situation or property damage.

Therefore:

- ⇒ Insert or remove connectors only if these are dry and not conducting power.
- ⇒ All connectors must be firmly screwed into place while the installation is in operation.

**WARNING****Danger of short circuit due to coolant or lubricants!**

A short circuit in a voltage-conductive line can lead to unforeseeably dangerous situation or property damage. Therefore:

- ⇒ Place protective caps over the open end of power connectors during installation or when replacing drive components, particularly if coolant or lubricant could somehow be sprayed on them.

The terminal diagrams from INDRAMAT exclusively help laying out the installation's circuit diagrams!

- ⇒ Connect motor as specified in the installation circuit diagrams of the machine manufactured! The terminal diagram in section 4.1 can be used as a help.

Connecting Ready-Made Cables

Power Cables

**Connecting power connector for
MHD041
MHD071
and MHD090**

Follow the instructions below when connecting the power connector INS0681 with thread.

- ⇒ Place power connector at the thread of the connection housing in the correct position.
- ⇒ Manually tighten the screwed cap of the power connector. By slowing pulling the cable through it is possible to bring the power connector into its final position.
- ⇒ Tighten the screwed cap „manually and firmly“.

**Connecting power connector
MHD093
MHD112
and MHD115**

Follow the instructions below when connecting power connectors INS0381 or INS0481 with quick-release bayonette joint:

- ⇒ Set the power connector to the bayonette joint of the connector housing in its correct position.
- ⇒ Turn the screwed cap of the power connector by hand until it clicks into its end position (identified by red point and red triangular that are now opposite each other).

Feedback Cable

**Connecting the feedback
connector**

Follow the instructions below when mounting the feedback connector:

- ⇒ Set the feedback connector to the thread of the connector housing in its correct position.
- ⇒ Manually tighten the screwed cap of the feedback connector. By pulling through the cable it is possible to gradually bring the feedback connector into its end position.
- ⇒ Fix the screwed cap "manually and firmly" into place.

Changing the Output Direction of Power and Feedback Connectors

Power connector

Changing connector output directions on MHD041 MHD071 MHD090

The output direction of the power connectors of MHD041, MHD071 and MHD090 motors can be selected at the time of mounting. The flanged socket can be turned (angle of turn is 270°).

How to set the cable direction wanted is described below.

Note: Do not use any tools, e.g., pliers or screwdrivers, for turning the flanged socket of the motor. This could damage the socket.

The flange of the motor is easy to turn if the correct plug is mounted. The lever effect of the plug means that the flanged socket can be turned to the desired direction by hand.

How to proceed:

⇒ Connect the motor power cable to the flanged socket.

⇒ By turning the connected plug the socket can be moved into the desired output direction.

The desired output direction is thus set.

Note: Each turn of the flanged socket decreases the holding torque in the set position. To ensure the needed holding torque of the flanged socket, the cable output direction should be changed a maximum of five times!

A „change“ (removal or mounting of the flanged socket by 90°) in the flanged socket is not necessary. The following problems and risks can result from such a "change".

- The O ring seal between socket and motor housing can no longer be guaranteed.
- The required tightening torques may no longer be maintained.
- The TFL coating (screw locking device) of the mounting screws is worn down with each turn and becomes ineffective as a result.

Note: Forfeiture of guarantee!

If the cable direction is „**changed**“, then the guarantee is forfeited for the entire drive system. Change the cable output direction only by turning the flanged socket.

Changing the cable output direction on MHD093 MHD112 MHD115

If the cable output direction of the power connectors was not taken into consideration at the time either MHD093, MHD112 or MHD115 were ordered, and it does not agree with the desired direction, then the cable can be turned by 90°.

Proceed as follows in this case:

⇒ Release the two mounting screws **4** and remove the lid of the connector box **2**.

- ⇒ Release the four mounting screws **3**.
- ⇒ Turn the connector housing **1** opposite the motor housing into the desired position in increments of 90°.
- ⇒ Make sure tht no cable cores are damaged or that unnecessary strain is caused. Use the opening that is made available when the lid of the connector housing **2** is removed.
- ⇒ Retighten the four mounting screws **3** (tightening torque 3.1 Nm \pm 10%).
- ⇒ Make sure when retightening the screws that no cable cores or seals are damaged in any way.
- ⇒ Replace and retighten the lid of the connector housing **2** and reightening the four mounting screws (tightening torque 3.1 Nm \pm 10%).

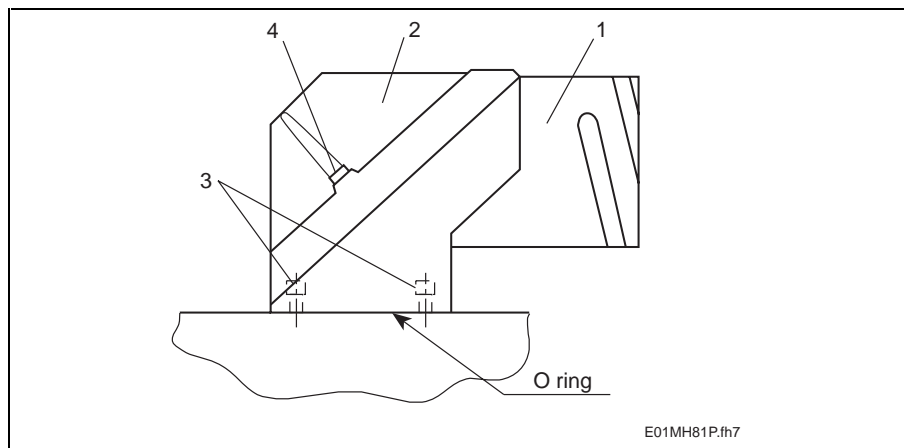

Fig. 15-1: Turning the power connectors

Note: The output direction of the connector can be set at the time of order using the relevant type codes.

Feedback connector

Changing the connector output directions on MHD041 MHD071 MHD090

The output direction of MHD041, MHD071 and MHD090 motors can be selected at the time of mounting. The flanged socket can be turned (angle of turn 270°).

How to set the desired connector output direction is described below.

Note: Do not use any tools, e.g., pliers or screwdrivers, for turning the flanged socket of the motor. This could damage the socket.

The flange of the motor is easy to turn if the correct plug is mounted. The lever effect of the plug means that the flanged socket can be turned to the desired direction by hand.

How to proceed:

- ⇒ Connect the motor feedback cable to the flanged socket.
- ⇒ By turning the connected plug the socket can be moved into the desired output direction.

The desired output direction is thus set.

Note: Each turn of the flanged socket decreases the holding torque in the set position. To ensure the needed holding torque of the flanged socket, the cable output direction should be changed a maximum of five times!

A „change“ (removal and mounting of the flanged socket by 90°) in the flanged socket is not necessary. The following problems and risks can result from such a "change".

- The O ring seal between socket and motor housing can no longer be guaranteed.
- The required tightening torques may no longer be maintained.
- The TFL coating (screw locking device) of the mounting screws is worn down with each turn and becomes ineffective as a result.

Note: Forfeiture of guarantee!
If the cable direction is „changed“, then the guarantee is forfeited for the entire drive system. Change the cable output direction only by turning the flanged socket.

Changing the cable output direction on
MHD093
MHD112
MHD115

If the cable output direction of the angle feedback connectors in MHD093, MHD112 and MHD115 motors does not agree with the direction wanted, then it can be turned by 90°. Proceed as follows to do this:

- ⇒ Release the four mounting screws on the top side of the connector.
- ⇒ Turn the connector part with screwed cap opposite the connector housing into the desired position (in increments of 90°).
- ⇒ Retighten the mounting screws (tightening torque 0.8 Nm ±10%).
- ⇒ Make sure that neither cable strands nor seals are damaged when retightening the screws.

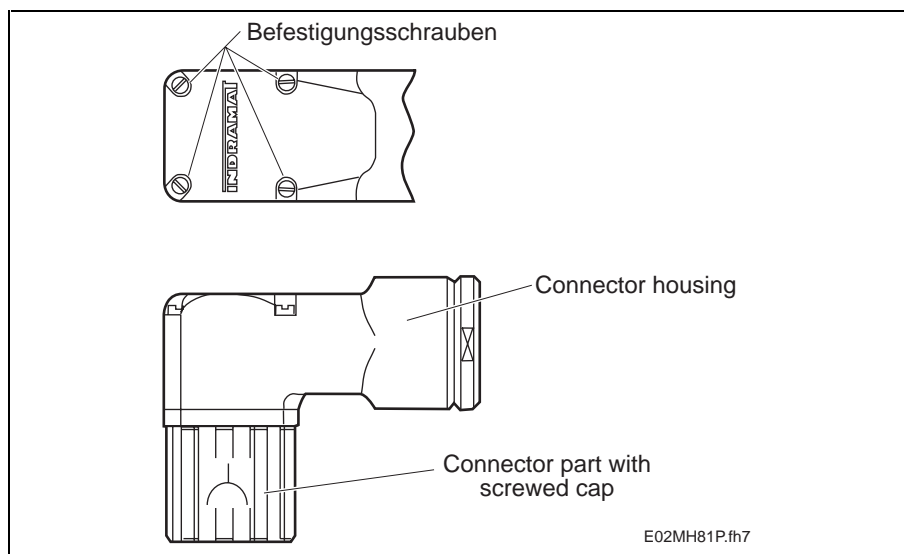

Fig. 15-2: Designation of connector part with angle feedback connectors

Note: In the case of applications with higher vibration and shock loads additionally secure the feedback connector with a screw glue to keep it in place.

15.4 Connecting and Mounting the Blower Connector

Electrical connection The connecting cable should have three strands with a minimum connecting cross section of 0.75 mm^2 .

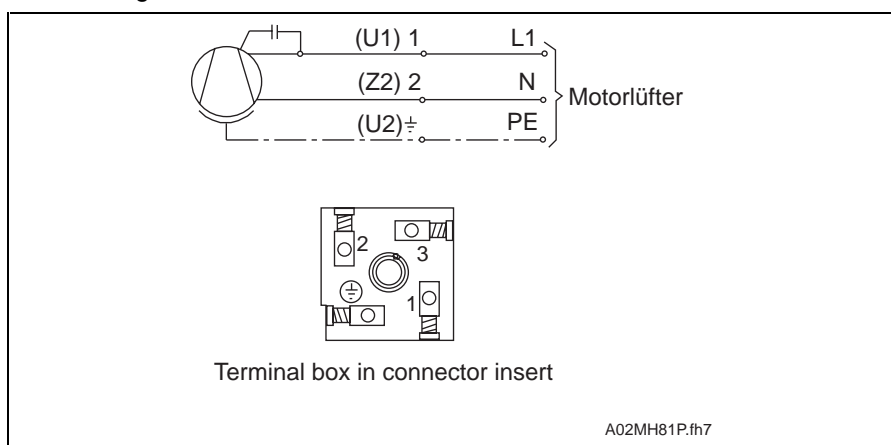

Fig. 15-3: Connection schematics of the blower

Instructions on mounting the connecting cable to the blower connector:

- ⇒ Release the conduit thread **6** (SW 17).
- ⇒ Release socket screw **1** with screwdriver **5** out of socket **4**.
- ⇒ Release connector housing **2** with connector insert **3** from socket **4**.
- ⇒ Remove socket screw **1**.
- ⇒ Pry connector insert **3** out using screwdriver **5** (see Fig. 15-4) and pull out of connector housing **2**.
- ⇒ Place conduit thread **6**, ring **7**, gasket **8** and connector housing **2** onto connector housing ($3 \times 0.75 \text{ mm}^2$).
- ⇒ Strip about 20 mm off of outer cable sheath, about 10 mm of stranded conductor and connect at connector insert **3** as shown above.
- ⇒ Insert connector insert **3** into connector housing **2**, put socket screw **1** into place, screw connector into socket **4**.
- ⇒ Tighten conduit thread **6** noting the strain relief.

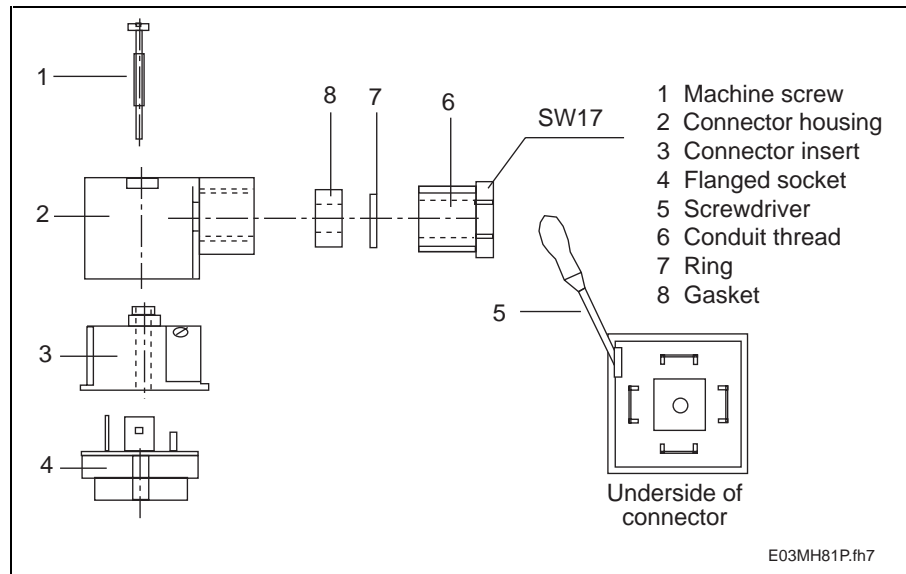

Fig. 15-4: Mounting the connecting cable at the blower connector

15.5 Cleaning the Holding Brakes

Note: The holding brake can wear down prematurely!
 The holding brake wears down after approximately 20,000 motor rotations when applied. Please therefore note the following instructions!

To ensure a proper functioning of the holding brake check the holding torque of the brake prior to installation.

If the holding torque specified in the data sheets is not achieved then it is necessary to grind the brake.

To do this it is necessary to remove all connections between motor and drive controller, e.g., power and feedback cables.

⇒ Make sure that the motor is not electrically connected to the drive controller.

⇒ Turn the motor shaft in comparison to the motor housing with the holding brake closed for approximately 50 rotations.

The holding brake can now be used.

16 Service Guidelines

16.1 Maintenance

The following should be performed regularly after the first year:

- The motors should be cleaned of dust, chips or similar.
- Control motor blower of the surface cooling unit.
- Check air circulation of cooling units.
- Check liquid cooling units for pressure, coolant levels, flow and so on.

16.2 Contacting Customer Service

To rapidly and effectively eliminate problems that may occur use our Service Hotline.

⇒ Prior to telephoning, note the following:

- type designations of the relevant drive controllers and motors
- the problem
- the readings of fault and diagnostics displays, if present.

The Service-Hotline can be reached:

Monday - Friday	7 - 23 CET
Saturday	8 - 20 CET
Sundays and holidays	9 - 19 CET

at

0171 - 333 882 6 or 0172 - 660 040 6.

⇒ If motors are returned to us, then please make a copy of the following Fault Report, fill it out completely and include it with the motor.

⇒ If the motors are liquid cooled, then remove all coolant prior to transport. There otherwise exists the danger of the coolant freezing over and damaging the lines.

⇒ Add a copy of the fault report to the machine documents so that the user of the machine can have access to it in the event repairs should become necessary.

This will ensure a rapid repair and help to quickly locate any application-dependent problems.

16.3 Fault Report

See next page.



Fault Report for DIAX04 Units

This report is intended to clarify problems and their causes. It is absolutely necessary in order to find hidden, sporadic or application-related problems and to eliminate them.
 - Always include fault report when sending in repairs.
 - Otherwise mail fault reports to your local INDRAMAT representative or to the address printed on the reverse.
 INDRAMAT appreciates your cooperation.

Fault report from:

Co.:	Loc.:	Tele.:
Dept.:	Name:	Date:

Data on HDD:

Data on plug-in module:
 DSS 2. __
 Serial no. _____

Data on software module
 FWC-HSM __ - - - - V - -MS
 S.No.: _____

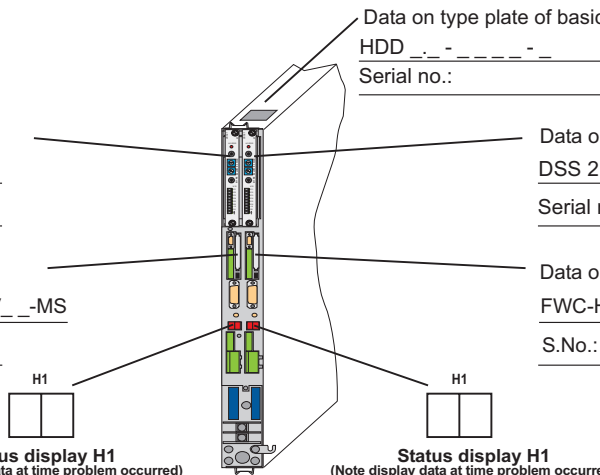

Data on plug-in module:
 DSS 2. __
 Serial no: _____

Data on software module
 FWC-HSM __ - - - - V - -MS
 S.No.: _____

Motor data:

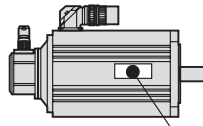

Motor type: _____
 Serial no. _____

Motor data:

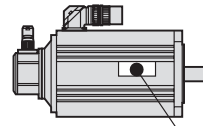

Motor type: _____
 Serial no.: _____

Data on HDS:

Data on plug-in module:
 DSS 2. __
 Serial no.: _____

Data on software module
 FWC-HSM __ - - - - V - -MS
 S.No.: _____

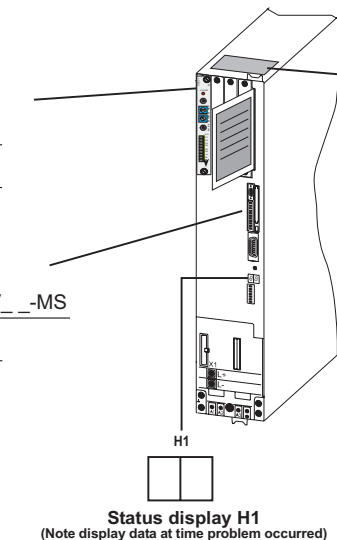

Data on type plate of basic unit
 HDS __ - - - - -
 Serial no.: _____

Motor data:

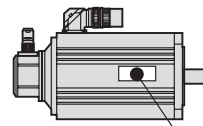

Motor type: MHD _____
 Serial no: _____

Please note back of page!

u01mh81p.fh7

Indramat GmbH • Bgm.-Dr.-Nebel-Straße 2 • D-97816 Lohr • Telefon 09352 / 404-0 • Tx 689 421 • Fax 09352 / 404-885

Fig. 16-1: Faulty report: page 1



**Fault Report
for DIAX04 Units**

Data on HVE or HVR:

Data on type plate of basic unit

HVE _ . _ - _ _ _ _ - _

Serial no: _____

or

HVR _ . _ - _ _ _ _ - _

Serial no: _____

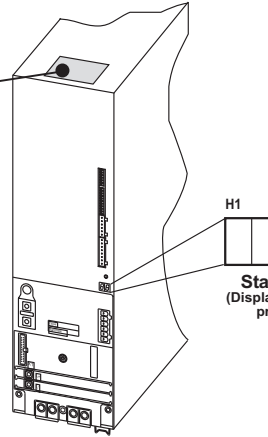

H1
Status display H1
(Display information at time problem occurred)

Data on machine with problem:

Type: _____ Oper. hrs.: _____ Where problem: _____

Machine number: _____ Comm. date _____

Number of drives _____

In which axis did the problem take place: _____ -axis _____

Explain the problem:

Additional data:

Problem:	Cause:	Other problems	
<input type="checkbox"/> is constantly present <input type="checkbox"/> at commissioning <input type="checkbox"/> sporadically present <input type="checkbox"/> occurs after <input type="checkbox"/> hrs. <input type="checkbox"/> occurs with shocks <input type="checkbox"/> is temperature-dep.	<input type="checkbox"/> unknown <input type="checkbox"/> conn. error <input type="checkbox"/> external causes <input type="checkbox"/> mechanical damage <input type="checkbox"/> lose line connection <input type="checkbox"/> moisture in unit <input type="checkbox"/> foreign object in unit	<input type="checkbox"/> Problem in mechanics <input type="checkbox"/> mains failures <input type="checkbox"/> control failure <input type="checkbox"/> motor failure <input type="checkbox"/> cable break <input type="checkbox"/> defective blower <input type="checkbox"/> defective feedback	Have there previously been problems with this axis? How often _____ Did problems occur on certain days or times of the day? _____ _____

u02mh81p.fh7

Indramat GmbH • Bgm.-Dr.-Nebel-Straße 2 • D-97816 Lohr • Telefon 09352 / 404-0 • Tx 689 421 • Fax 09352 / 404-885

Fig. 16-2: Fault report: page 2

17 Index

A

Ambient Temperature 3-1
Ambient temperature and installation elevation 3-1
Application range 1-1

B

Barcode sticker 13-1
Bearing service life 3-9

C

Cable cross sections 4-15, 4-16, 4-17
Commutation 1-1, 1-3
Components 1-3
Construction 1-3
Coolant 5-1
Coolant lines 5-1
Cooling method 1-3
Cooling system components 5-1

D

Designs 1-3
Digital servo feedback (HSF) 1-4
Digital servo feedback(HSF) with integral multiturn absolute encoder 1-4
Dynamics 1-1

E

Electrical connection
 feedback cables 4-12
 Feedback connectors 4-18
 Parts 4-14
 power cable 4-2
Electrical connections
 angle feedback connectors 3-14
 plans for MHD motors 4-1

F

feedback cables 4-12
Feedback connector 15-3
Feedback connectors 4-18
Feedback data memory 1-4

H

Holding brake 1-3, 3-11
Housing Finish 3-6

I

Installation circuit diagrams 15-2
Installation Elevation 3-1

K

Knee speed 3-15

L

Liquid cooling 3-11

Load factor 3-1

M

Maintenance-free operation 1-1

Motor feedback 1-3, 1-4

Technical data 1-4

Mounting drive elements 3-10

O

Operating curves 3-15

Operating reliability 1-1

Output direction 3-13

Output shaft 1-3

Output shaft with keyway 3-8

Plain output shaft 3-7

Shaft load 3-8

Thermal changes in length 3-9

Overload capabilities 1-1

P

Power cables 4-2

Power connector 15-4

Power data 1-1

Power overview 1-2

Pressure drop 5-2

Prime Coat 3-6

Protection against contact with hot parts 2-8

Protection category 3-2

S

Safety Instructions 2-1

Battery safety 2-9

General 2-3

Hazards by improper use 2-2

Protection against contact with electrical parts and not grounded enclosures 2-4

Protection against dangerous movements 2-6

Protection against magnetic and electromagnetic fields during operations and mounting 2-7

Protection by protective low voltage (PELV) against electrical shock 2-5

Protection during handling and installation 2-8

Safety Instructions for Electrical Drives 2-1

Service-Hotline 16-1

Shaft capacity

MHD041 6-4

MHD071 7-4

MHD091 8-4

MHD093 9-7

MHD112 10-9

MHD115 11-6

Shaft load

Allowed axial force 3-9

Allowed radial force 3-8

Maximum allowed radial force 3-8

Shock demands 3-6

Surface cooling 3-10

T

Type Codes

MHD041 6-6

MHD071 7-6

MHD090 8-6

MHD093 9-10

MHD112 10-12

MHD115 11-9

Type of position detection

absolute 1-4
relative 1-4
Type plate 13-2

V

via specific bearings 3-10
Vibration demands 3-6

18 Kundenbetreuungsstellen - Sales & Service Facilities

Deutschland – Germany

vom Ausland: (0) nach Landeskennziffer weglassen!!
from abroad: don't dial (0) after country code!

Vertriebsgebiet Mitte Germany Centre <input checked="" type="checkbox"/> SALES <input checked="" type="checkbox"/> Service INDRAMAT GmbH Bgm.-Dr.-Nebel-Str. 2 D - 97816 Lohr am Main Telefon: +49 (0)9352/40-0 Telefax: +49 (0)9352/40-4885	Vertriebsgebiet Ost Germany East <input checked="" type="checkbox"/> SALES <input checked="" type="checkbox"/> Service INDRAMAT GmbH Beckerstraße 31 D - 09120 Chemnitz Telefon: +49 (0)371/35 55-0 Telefax: +49 (0)371/35 55-333	Vertriebsgebiet West Germany West <input checked="" type="checkbox"/> SALES <input checked="" type="checkbox"/> Service Mannesmann Rexroth AG Vertrieb Deutschland Regionalzentrum West Borsigstrasse 15 D - 40880 Ratingen Telefon: +49 (0)2102/409-0 Telefax: +49 (0)2102/409-406	Vertriebsgebiet Nord Germany North <input checked="" type="checkbox"/> SALES <input type="checkbox"/> Service INDRAMAT GmbH Kieler Straße 212 D - 22525 Hamburg Telefon: +49 (0)40/85 31 57-0 Telefax: +49 (0)40/85 31 57-15
Vertriebsgebiet Süd Germany South <input checked="" type="checkbox"/> SALES <input type="checkbox"/> Service INDRAMAT GmbH Ridlerstraße 75 D-80339 München Telefon: +49 (0)89/540138-30 Telefax: +49 (0)89/540138-10 indramat.mue@t-online.de	Gebiet Südwest Germany South-West <input checked="" type="checkbox"/> SALES <input checked="" type="checkbox"/> Service INDRAMAT GmbH Böblinger Straße 25 D-71229 Leonberg Telefon: +49 (0)7152/9 72-6 Telefax: +49 (0)7152/9 72-727	Vertriebsgebiet Mitte Germany Centre <input checked="" type="checkbox"/> SALES <input type="checkbox"/> Service Mannesmann Rexroth AG Geschäftsbereich INDRAMAT Lilistraße 14-18 D – 63067 Offenbach Telefon: +49 (0) 62/82 00 90-0 Telefax: +49 (0) 62/82 00 90-80	Vertriebsgebiet Nord Germany North <input checked="" type="checkbox"/> SALES <input type="checkbox"/> Service Mannesmann Rexroth AG Vertriebsniederlassung Region Nord Geschäftsbereich INDRAMAT Schützenstraße 20 D – 30853 Langenhagen Telefon: +49 (0) 511/72 66 57-0 Telefax: +49 (0) 511/72 66 57-93
			INDRAMAT Service-Hotline INDRAMAT GmbH Telefon: +49 (0)172/660 04 06 oder/or Telefon: +49 (0)171/333 88 26 Hotline ERSATZTEILE: - nur an Werktagen von 15 -18 Uhr - +49 (0) 93 52/40 42 22

Kundenbetreuungsstellen in Deutschland - Service agencies in Germany

Europa – Europe

vom Ausland: (0) nach Landeskennziffer weglassen,

0 nach Landeskennziffer mitwählen!

from abroad: don't dial (0) after country code,

dial 0 after country code!

<p>Austria <input checked="" type="checkbox"/> SALES <input type="checkbox"/> Service</p> <p>Mannesmann Rexroth Ges.m.b.H. Geschäftsbereich INDRAMAT Hägelingasse 3 A - 1140 Wien</p> <p>Telefon: +43 (0)1/9852540-400 Telefax: +43 (0)1/9852540-93</p>	<p>Austria <input checked="" type="checkbox"/> SALES <input type="checkbox"/> Service</p> <p>Mannesmann Rexroth G.m.b.H. Geschäftsbereich INDRAMAT Industriepark 18 A - 4061 Pasching</p> <p>Telefon: +43 (0)7221/605-0 Telefax: +43 (0)7221/605-21</p>	<p>Belgium <input checked="" type="checkbox"/> SALES <input checked="" type="checkbox"/> Service</p> <p>Mannesmann Rexroth N.V.-S.A. Geschäftsbereich INDRAMAT Industrielaan 8 B-1740 Ternat</p> <p>Telefon: +32 (0)2/5830719 Telefax: +32 (0)2/5830731</p>	<p>Denmark <input checked="" type="checkbox"/> SALES <input checked="" type="checkbox"/> Service</p> <p>BEC AS Zinkvej 6 DK-8900 Randers</p> <p>Telefon: +45 (0)87/11 90 60 Telefax: +45 (0)87/11 90 61</p>
<p>England <input checked="" type="checkbox"/> SALES <input checked="" type="checkbox"/> Service</p> <p>Mannesmann Rexroth Ltd. INDRAMAT Division Broadway Lane, South Cerney GB - Cirencester, Glos GL7 5UH</p> <p>Telefon: +44 (0)1285/863000 Telefax: +44 (0)1285/863030</p> <p>sales@indramat.co.uk ukservice@indramat.co.uk</p>	<p>Finland <input checked="" type="checkbox"/> SALES <input type="checkbox"/> Service</p> <p>Rexroth Mecman Oy INDRAMAT division Ansatie 6 SF-017 40 Vantaa</p> <p>Telefon: +358 (0)9/84 91-11 Telefax: +358 (0)9/84 91-13 60</p>	<p>France <input checked="" type="checkbox"/> SALES <input checked="" type="checkbox"/> Service</p> <p>Mannesmann Rexroth S.A. Division INDRAMAT Parc des Barbanniers 4, Place du Village F-92632 Gennevilliers Cedex</p> <p>Telefon: +33 (0)141 47 54 30 Telefax: +33 (0)147 94 69 41 Hotline: +33 (0)6 08 33 43 28</p>	<p>France <input checked="" type="checkbox"/> SALES <input type="checkbox"/> Service</p> <p>Mannesmann Rexroth S.A. Division INDRAMAT 270, Avenue de Lardenne F - 31100 Toulouse</p> <p>Telefon: +33 (0)5 61 49 95 19 Telefax: +33 (0)5 61 31 00 41</p>
<p>France <input checked="" type="checkbox"/> SALES <input type="checkbox"/> Service</p> <p>Mannesmann Rexroth S.A. Division INDRAMAT 91, Bd. Irène Joliot-Curie F - 69634 Vénissieux – Cedex</p> <p>Telefon: +33 (0)4 78 78 53 65 Telefax: +33 (0)4 78 78 52 53</p>	<p>Italy <input checked="" type="checkbox"/> SALES <input checked="" type="checkbox"/> Service</p> <p>Mannesmann Rexroth S.p.A. Division INDRAMAT Via G. Di Vittoria, 1 I - 20063 Cernusco S/N.MI</p> <p>Telefon: +39 02/92 36 52 70 Telefax: +39 02/92 36 55 12</p>	<p>Italy <input checked="" type="checkbox"/> SALES <input checked="" type="checkbox"/> Service</p> <p>Mannesmann Rexroth S.p.A. Divisione INDRAMAT Via Borgomanero, 11 I - 10145 Torino</p> <p>Telefon: +39 011/7 50 38 11 Telefax: +39 011/7 71 01 90</p>	<p>Italy <input checked="" type="checkbox"/> SALES <input type="checkbox"/> Service</p> <p>Mannesmann Rexroth S.p.A. Divisione INDRAMAT Via del Progresso, 16 (Zona Ind.) I - 35020 Padova</p> <p>Telefon: +39 049/8 70 13 70 Telefax: +39 049/8 70 13 77</p>
<p>Italy <input type="checkbox"/> SALES <input checked="" type="checkbox"/> Service</p> <p>Mannesmann Rexroth S.p.A. Divisione Rexroth Indramat Via Mascia, 1 I - 80053 Castellammare di Stabia NA</p> <p>Telefon: +39 081/8 71 57 00 Telefax: +39 081/8 71 68 86</p>	<p>Italy <input checked="" type="checkbox"/> SALES <input type="checkbox"/> Service</p> <p>Mannesmann Rexroth S.p.A. Divisione INDRAMAT Viale Oriani, 38/A I - 40137 Bologna</p> <p>Telefon: +39 051/34 14 14 Telefax: +39 051/34 14 22</p>	<p>Netherlands <input checked="" type="checkbox"/> SALES <input type="checkbox"/> Service</p> <p>Hydraudyne Hydrauliek B.V. Kruisbroeksestraat 1 (P.O. Box 32) NL - 5281 RV Boxtel</p> <p>Telefon: +31 (0)411/65 19 51 Telefax: +31 (0)411/65 14 83 e-mail: indramat@hydraudyne.nl</p>	<p>Netherlands <input type="checkbox"/> SALES <input checked="" type="checkbox"/> Service</p> <p>Hydrocare B.V. Kruisbroeksestraat 1 (P.O. Box 32) NL - 5281 RV Boxtel</p> <p>Telefon: +31 (0)411/65 19 51 Telefax: +31 (0)411/67 78 14</p>
<p>Norway <input checked="" type="checkbox"/> SALES <input type="checkbox"/> Service</p> <p>Rexroth Mecman AS INDRAMAT Division Berghagan 1 or Box 3007 N-1405 Ski-Langhus N-1402 Ski</p> <p>Telefon: +47 (0)64 86 41 00 Telefax: +47 (0)64 86 90 62</p> <p>jul.ruud@rexroth.no</p>	<p>Poland <input checked="" type="checkbox"/> SALES <input type="checkbox"/> Service</p> <p>Mannesmann Rexroth Sp.zo.o. Biuro Poznan ul. Dabrowskiego 81/85 PL – 60-529 Poznan</p> <p>Telefon: +48 061/847 67 99 Telefax: +48 061/847 64 02</p>	<p>Russia <input type="checkbox"/> SALES <input checked="" type="checkbox"/> Service</p> <p>Tschudnenko E.B. Arsenia 22 RUS - 153000 Ivanovo Rußland</p> <p>Telefon: +7 093/223 96 33 oder/or +7 093/223 95 48 Telefax: +7 093/223 46 01</p>	<p>Spain <input checked="" type="checkbox"/> SALES <input checked="" type="checkbox"/> Service</p> <p>Mannesmann Rexroth S.A. Division INDRAMAT Centro Industrial Santiga Obrodors s/n E-08130 Santa Perpetua de Mogoda Barcelona</p> <p>Telefon: +34 937 47 94 00 Telefax: +34 937 47 94 01</p>
<p>Spain <input checked="" type="checkbox"/> SALES <input checked="" type="checkbox"/> Service</p> <p>Goimendi S.A. Division Indramat Jolastokieta (Herrera) Apartado 11 37 E - 20017 San Sebastian</p> <p>Telefon: +34 9 43/40 01 63 Telefax: +34 9 43/39 17 99</p>	<p>Sweden <input checked="" type="checkbox"/> SALES <input checked="" type="checkbox"/> Service</p> <p>Rexroth Mecman Svenska AB INDRAMAT Division Varuvägen 7 S - 125 81 Stockholm</p> <p>Telefon: +46 (0)8/727 92 00 Telefax: +46 (0)8/647 32 77</p>	<p>Slowenia <input checked="" type="checkbox"/> SALES <input checked="" type="checkbox"/> Service</p> <p>INDRAMAT elektromotorji d.o.o. Otoki 21 SLO - 64 228 Zelezniki</p> <p>Telefon: +386 64/61 73 32 Telefax: +386 64/64 71 50</p>	<p>Turkey <input checked="" type="checkbox"/> SALES <input checked="" type="checkbox"/> Service</p> <p>Mannesmann Rexroth Hidropar A.S. Fevzi Cakmak Cad No. 3 TR - 34630 Sefaköy Istanbul</p> <p>Telefon: +90 212/541 60 70 Telefax: +90 212/599 34 07</p>
<p>Switzerland <input checked="" type="checkbox"/> SALES <input checked="" type="checkbox"/> Service</p> <p>-East-</p> <p>Mannesmann Rexroth Schweiz AG Geschäftsbereich INDRAMAT Gewerbstraße 3 CH-8500 Frauenfeld</p> <p>Telefon: +41 (0)52/720 21 00 Telefax: +41 (0)52/720 21 11</p>	<p>Switzerland <input checked="" type="checkbox"/> SALES <input type="checkbox"/> Service</p> <p>-West-</p> <p>Mannesmann Rexroth Suisse SA Département INDRAMAT Rue du village 1 CH-1020 Renens</p> <p>Telefon: +41 (0)21/632 84 20 Telefax: +41 (0)21/632 84 21</p>		

Europäische Kundenbetreuungsstellen (ohne Deutschland)

European Service agencies (without Germany)

Außerhalb Europa - outside Europe

vom Ausland: (0) nach Landeskennziffer weglassen!
from abroad: don't dial (0) after country code!

<p>Argentina <input checked="" type="checkbox"/> SALES <input type="checkbox"/> Service</p> <p>Mannesmann Rexroth S.A.I.C. Division INDRAMAT Acassusso 48 41/7 RA - 1605 Munro (Buenos Aires)</p> <p>Telefon: +54 (0)11/4756 01 40 Telefax: +54 (0)11/4762 6862 e-mail:mannesmann@impsat1.com.ar</p>	<p>Argentina <input checked="" type="checkbox"/> SALES <input checked="" type="checkbox"/> Service</p> <p>NAKASE Servicio Tecnico CNC Calle 49, No. 5764/66 RA - 1653 Villa Balester Prov. - Buenos Aires</p> <p>Telefon: +54 (0) 11/4768 36 43 Telefax: +54 (0) 11/4768 24 13 e-mail: nakase@usa.net nakase@infovia.com.ar</p>	<p>Australia <input checked="" type="checkbox"/> SALES <input checked="" type="checkbox"/> Service</p> <p>AIMS - Australian Industrial Machinery Services Pty. Ltd. Unit 3/45 Home ST Campbellfield , VIC 3061 AUS - Melbourne</p> <p>Telefon: +61 (0)3/93 59 02 28 Telefax: +61 (0)3/93 59 02 86</p>	<p>Australia <input checked="" type="checkbox"/> SALES <input type="checkbox"/> Service</p> <p>Mannesmann Rexroth Pty. Ltd. No. 7, Endeavour Way Braeside Victoria, 31 95 AUS - Melbourne</p> <p>Telefon: +61 (0)3/95 80 39 33 Telefax: +61 (0)3/95 80 17 33 Email: mel@rexroth.com.au</p>
<p>Brazil <input checked="" type="checkbox"/> SALES <input checked="" type="checkbox"/> Service</p> <p>Mannesmann Rexroth Automação Ltda. Divisão INDRAMAT Rua Georg Rexroth, 609 Vila Padre Anchieta BR - 09951-270 Diadema-SP [Caixa Postal 377] [BR-09901-970 Diadema-SP]</p> <p>Telefon: +55 (0)11/745 90 60 +55 (0)11/745 90 70 Telefax: +55 (0)11/745 90 50 e-mail: awittwer@rexroth.com.br</p>	<p>Brazil <input type="checkbox"/> SALES <input checked="" type="checkbox"/> Service</p> <p>Mannesmann Rexroth Automação Ltda. Divisão INDRAMAT R. Dr.Humberto Pinheiro Vieira, 100 Distrito Industrial BR - 89220-390 Joinville - SC [Caixa Postal 1273]</p> <p>Tel./Fax: +55 (0)47/473 58 33 Mobil: +55 (0)47 974 66 45 e-mail: prochnow@zaz.com.br</p>	<p>Canada <input checked="" type="checkbox"/> SALES <input checked="" type="checkbox"/> Service</p> <p>Basic Technologies Corporation Burlington Division 3426 Mainway Drive Burlington, Ontario Canada L7M 1A8</p> <p>Telefon: +1 905/335 55 11 Telefax: +1 905/335-41 84</p>	<p>China <input type="checkbox"/> SALES <input checked="" type="checkbox"/> Service</p> <p>Mannesmann Rexroth (China) Ltd. Shanghai Parts & Service Center 199 Wu Cao Road, Hua Cao Minhang District PRC - Shanghai 201 103</p> <p>Telefon: +86 21/62 20 00 58 Telefax: +86 21/62 20 00 68</p>
<p>China <input checked="" type="checkbox"/> SALES <input type="checkbox"/> Service</p> <p>Mannesmann Rexroth (China) Ltd. 15/F China World Trade Center 1, Jianguomenwai Avenue PRC - Beijing 100004</p> <p>Telefon: +86 10/65 05 03 80 Telefax: +86 10/65 05 03 79</p>	<p>China <input checked="" type="checkbox"/> SALES <input type="checkbox"/> Service</p> <p>Mannesmann Rexroth (China) Ltd. A-5F., 123 Lian Shan Street Sha He Kou District PRC - Dalian 116 023</p> <p>Telefon: +86 411/46 78 930 Telefax: +86 411/46 78 932</p>	<p>Hongkong <input checked="" type="checkbox"/> SALES <input checked="" type="checkbox"/> Service</p> <p>Rexroth (China) Ltd. 1/F., 19 Cheung Shun Street Cheung Sha Wan, Kowloon, Hongkong</p> <p>Telefon: +852 22 62 51 00 Telefax: +852 27 44 02 78</p>	<p>India <input checked="" type="checkbox"/> SALES <input checked="" type="checkbox"/> Service</p> <p>Mannesmann Rexroth (India) Ltd. INDRAMAT Division Plot. 96, Phase III Peenya Industrial Area IND - Bangalore - 560058</p> <p>Telefon: +91 (0)80/8 39 73 74 Telefax: +91 (0)80/8 39 43 45</p>
<p>India <input checked="" type="checkbox"/> SALES <input checked="" type="checkbox"/> Service</p> <p>Mannesmann Rexroth (India) Ltd. INDRAMAT Division Plot. A-58, TTC Industrial Area Thane Turbhe Midc Road Mahape Village IND - Navi Mumbai - 400 701</p> <p>Telefon: +91 (0)22/7 61 46 22 Telefax: +91 (0)22/7 68 15 31</p>	<p>Indonesia <input checked="" type="checkbox"/> SALES <input type="checkbox"/> Service</p> <p>PT. Rexroth Wijayakusuma Jl. Raya Bekasi Km 21 Pulogadung RI - Jakarta Timur 13920</p> <p>Telefon: +62 21/4 61 04 87 +62 21/4 61 04 88 Telefax: +62 21/4 60 01 52</p>	<p>Japan <input type="checkbox"/> SALES <input checked="" type="checkbox"/> Service</p> <p>Rexroth Automation Co., Ltd. Service Center Japan Yutakagaoka 1810, Meito-ku, NAGOYA 465-0035, Japan</p> <p>Telefon: +81 (0)52/777 88 41 +81 (0)52/777 88 53 +81 (0)52/777 88 79 Telefax: +81 (0)52/777 89 01</p>	<p>Japan <input checked="" type="checkbox"/> SALES <input checked="" type="checkbox"/> Service</p> <p>Rexroth Automation Co., Ltd. INDRAMAT Division 1F, I.R. Building Nakamachidai 4-26-44, Tsuzuki-ku YOKOHAMA 224-0041, Japan</p> <p>Telefon: +81 (0)45/942 72 10 Telefax: +81 (0)45/942 03 41</p>
<p>Mexico <input checked="" type="checkbox"/> SALES <input type="checkbox"/> Service</p> <p>Mannesmann Rexroth Mexico S.A. de C.V. Calle Neptuno 72 Unidad Ind. Vallejo MEX - 07700 Mexico, D.F.</p> <p>Telefon: +52 5 754 17 11 +52 5 754 36 84 +52 5 754 12 60 Telefax: +52 5 754 50 73 +52 5 752 59 43 e-mail: gsoria@rexroth-mexico.com</p>	<p>Korea <input checked="" type="checkbox"/> SALES <input checked="" type="checkbox"/> Service</p> <p>Mannesmann Rexroth-Seki Co Ltd. 1500-12 Da-Dae-Dong ROK - Saha-Ku, Pusan, 604-050</p> <p>Telefon: +82 (0)51/2 60 06 18 Telefax: +82 (0)51/2 60 06 19</p>	<p>Korea <input checked="" type="checkbox"/> SALES <input checked="" type="checkbox"/> Service</p> <p>Seo Chang Corporation Ltd. Room 903, Jail Building 44-35 Yeouido-Dong Yeoungdeungpo-Ku C.P.O.Box 97 56 ROK - Seoul</p> <p>Telefon: +82 (0)2/7 80 82 08 +82 (0)2/7 80 82 09 Telefax: +82 (0)2/7 84 54 08</p>	<p>South Africa <input checked="" type="checkbox"/> SALES <input checked="" type="checkbox"/> Service</p> <p>TECTRA Automation (Pty) Ltd. 28 Banfield Road, Industria North RSA - Maraisburg 1700</p> <p>Telefon: +27 (0)11/673 20 80 Telefax: +27 (0)11/673 72 69 georgv@hyauto.com</p>
<p>Taiwan <input checked="" type="checkbox"/> SALES <input type="checkbox"/> Service</p> <p>Rexroth Uchida Co., Ltd. No.1, Tsu Chiang Street Tu Cheng Ind. Estate Taipei Hsien, Taiwan, R.O.C.</p> <p>Telefon: +886 2/2 68 13 47 Telefax: +886 2/2 68 53 88</p>		<p>minteke@ms2.hinet.net</p>	

Kundenbetreuungsstellen außerhalb Europa - Service agencies outside Europe

Außerhalb Europa / USA - outside Europe / USA

<p>USA <input checked="" type="checkbox"/> SALES <input checked="" type="checkbox"/> Service</p> <p>Mannesmann Rexroth Corporation INDRAMAT Division 5150 Prairie Stone Parkway USA -Hoffman Estates, IL 60192-3707</p> <p>Telefon: +1 847/6 45 36 00 Telefax: +1 847/6 45 62 01</p> <p>E-MAIL: service@indramat.com</p> <p>Service HOTLINE: +1-800-860-1055 -7 days/24hrs-</p>	<p>USA <input checked="" type="checkbox"/> SALES <input checked="" type="checkbox"/> Service</p> <p>Mannesmann Rexroth Corporation INDRAMAT Division Central Region Technical Center USA - Auburn Hills, MI 48326</p> <p>Telefon: +1 248/3 93 33 30 Telefax: +1 248/3 93 29 06</p>	<p>USA <input checked="" type="checkbox"/> SALES <input checked="" type="checkbox"/> Service</p> <p>Mannesmann Rexroth Corporation INDRAMAT Division Southeastern Technical Center 3625 Swiftwater Park Drive USA - Suwanee Georgia 30174</p> <p>Telefon: +1 770/9 32 32 00 +1 770/9 32 19 03</p>	<p>USA <input checked="" type="checkbox"/> SALES <input checked="" type="checkbox"/> Service</p> <p>Mannesmann Rexroth Corporation INDRAMAT Division Northeastern Technical Center 99 Rainbow Road USA - East Granby, Connecticut 06026</p> <p>Telefon: +1 860/8 44 83 77 +1 860/8 44 85 95</p>
<p>USA <input checked="" type="checkbox"/> SALES <input checked="" type="checkbox"/> Service</p> <p>Mannesmann Rexroth Corporation INDRAMAT Division Charlotte Regional Sales Office 14001 South Lakes Drive USA - Charlotte, North Carolina 28273</p> <p>Telefon: +1 704/5 83 97 62 +1 704/5 83 14 86</p>			

Kundenbetreuungsstellen außerhalb Europa / USA
Service agencies outside Europe / USA

273697

Printed in Germany

