



L-force Drives

Montageanleitung

Mounting Instructions

Instructions de montage

Instrucciones para el montaje

Istruzioni per il montaggio

EWS

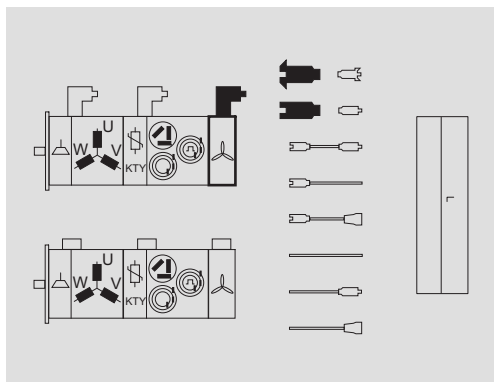

EWS0003, EWS1003

Systemstecker für Lüfterschluss (Buchse)

System connector for fan connection (female)

Connecteur système pour raccordement ventilateur (fiche femelle)

Conector de sistema para conexión de ventilador (hembra)

Connettore di sistema per collegamento ventilatore (femmina)

Lenze



Lesen Sie die Dokumentationen zum Grundgerät und zum Motor und das Handbuch "Systemleitungen und Systemstecker", bevor Sie mit den Arbeiten beginnen.



Before you start working, please read the documentation for the basic unit and the motor as well as the manual "System Cables and System Connectors".



Lire la documentation relative à l'appareil de base et au moteur ainsi que le manuel "Câbles système et connecteurs système" avant toute manipulation de l'équipement.



Antes de empezar con el trabajo, lea detenidamente la documentación del equipo básico y del motor, así como el manual "Cables y conectores de sistema".



Prima di utilizzare l'apparecchiatura, leggere la documentazione relativa al dispositivo base e al motore, nonché il manuale "Cavi e connettori di sistema".

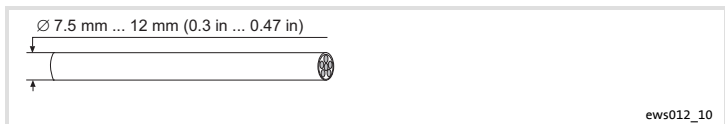
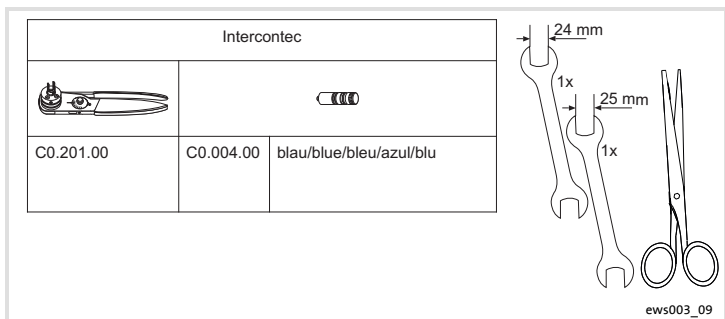
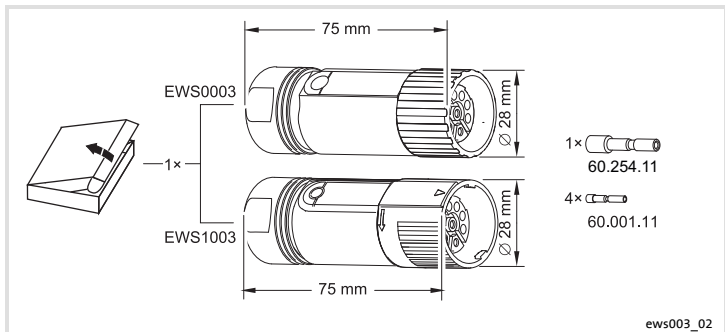

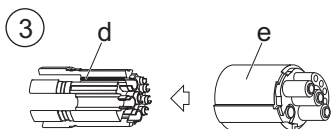
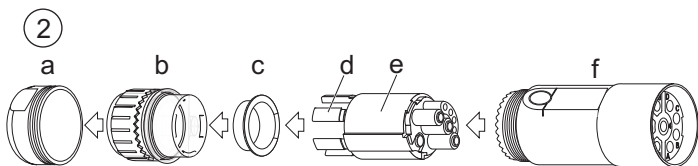
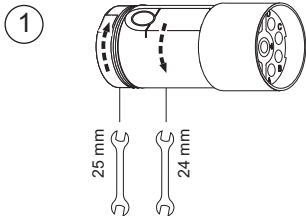

ews003_03

4

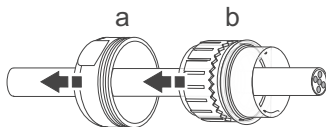

5

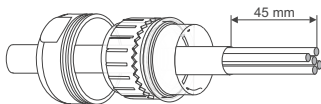

6

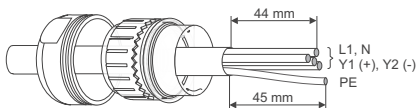

7

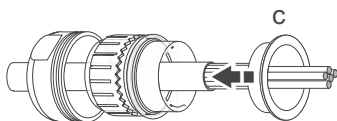

ews003_04

8

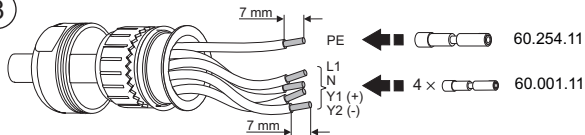

ews003_05

9

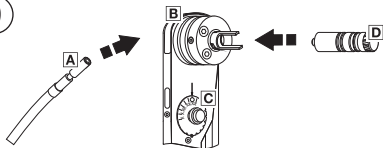

ews012_05b

		Intercontec					
		A	B	C		D	
mm ²	AWG						
1.0	18	60.254.11	C0.201.00	6	6	C0.004.00	blau / blue
1.0	18	60.003.11	C0.201.00	6	6		bleu / azul blu

10

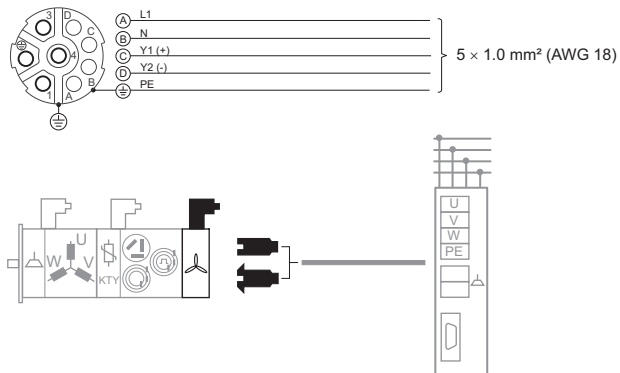

ews003_06

11

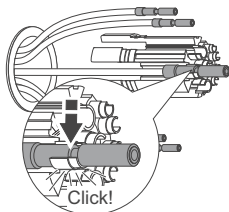
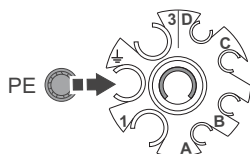
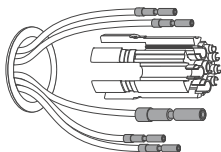

12

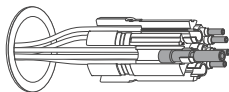
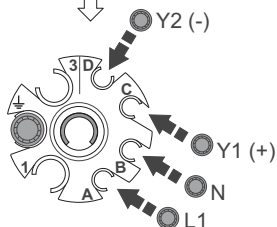
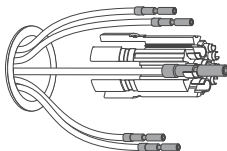

ews003_07

13

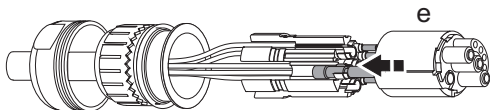

14

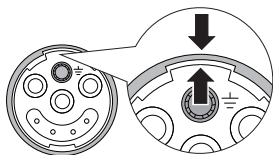
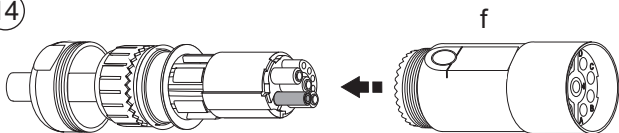

ews003_08

15

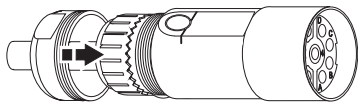

16

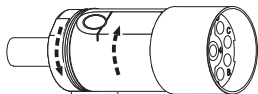

25 mm



24 mm

9 Nm (80.1 lb-in)

ews003_08

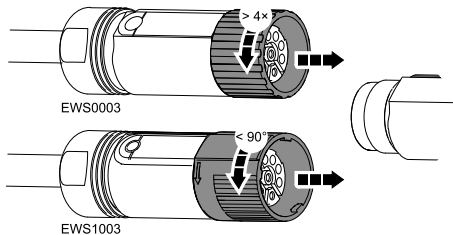

EWS0003

EWS1003

ews003_10

© 01/2014



Lenze Automation GmbH
Hans-Lenze-Str. 1
D-31855 Aerzen
Germany



+49 (0)51 54 / 82-0



+49 (0)51 54 / 82 - 28 00



Lenze@Lenze.de



www.Lenze.com

Service Lenze Service GmbH
Breslauer Straße 3
D-32699 Extertal
Germany



00 80 00 / 24 4 68 77 (24 h helpline)



+49 (0)51 54 / 82-11 12



Service@Lenze.de

EDKWS0003 ■ 13441622 ■ DE/EN/FR/ES/IT ■ 6.0 ■ TD00

10 9 8 7 6 5 4 3 2 1