Profibus-DP Communications Interface

Technical Manual
HA469761U001 Issue 4

© Copyright 2010 Parker Hannifin Ltd.

All rights strictly reserved. No part of this document may be stored in a retrieval system, or transmitted in any form or by any means to persons not employed by a Parker Hannifin Ltd., Automation Group, SSD Drives Europe without written permission from Parker Hannifin Ltd., Automation Group, SSD Drives Europe. Although every effort has been taken to ensure the accuracy of this document it may be necessary, without notice, to make amendments or correct omissions. Parker Hannifin Ltd., Automation Group, SSD Drives Europe cannot accept responsibility for damage, injury, or expenses resulting there from.

WARRANTY

Parker Hannifin Ltd., Automation Group, SSD Drives Europe, warrants the goods against defects in design, materials and workmanship for the period of 24 months from the date of manufacture, or 12 months from the date of delivery (whichever is the longer period) on the terms detailed in Parker SSD Drives Standard Conditions of Sale IA500504.

Parker Hannifin Ltd., Automation Group, SSD Drives Europe reserves the right to change the content and product specification without notice.

FAILURE OR IMPROPER SELECTION OR IMPROPER USE OF THE PRODUCTS DESCRIBED HEREIN OR RELATED ITEMS CAN CAUSE DEATH, PERSONAL INJURY AND PROPERTY DAMAGE.

This document and other information from Parker-Hannifin Corporation, its subsidiaries and authorized distributors provide product or system options for further investigation by users having technical expertise.

The user, through its own analysis and testing, is solely responsible for making the final selection of the system and components and assuring that all performance, endurance, maintenance, safety and warning requirements of the application are met. The user must analyze all aspects of the application, follow applicable industry standards, and follow the information concerning the product in the current product catalog and in any other materials provided from Parker or its subsidiaries or authorized distributors.

To the extent that Parker or its subsidiaries or authorized distributors provide component or system options based upon data or specifications provided by the user, the user is responsible for determining that such data and specifications are suitable and sufficient for all applications and reasonably foreseeable uses of the components or systems.

Safety Information



Requirements

IMPORTANT: Please read this information BEFORE installing the equipment.

Intended Users

This manual is to be made available to all persons who are required to install, configure or service equipment described herein, or any other associated operation.

The information given is intended to highlight safety issues, EMC considerations, and to enable the user to obtain maximum benefit from the equipment.

Complete the following table for future reference detailing how the unit is to be installed and used.

INSTALLATION DETAILS	
Model Number <i>(see product label)</i>	
Where installed <i>(for your own information)</i>	
Unit used as a: <i>(refer to Certification for the Inverter)</i>	<input type="radio"/> Component <input type="radio"/> Relevant Apparatus
Unit fitted:	<input type="radio"/> Wall-mounted <input type="radio"/> Enclosure



Application Area

The equipment described is intended for industrial motor speed control utilising DC motors, AC induction or AC synchronous machines

Personnel

Installation, operation and maintenance of the equipment should be carried out by qualified personnel. A qualified person is someone who is technically competent and familiar with all safety information and established safety practices; with the installation process, operation and maintenance of this equipment; and with all the hazards involved.

Product Warnings

	Caution Risk of electric shock		Caution Refer to documentation		Earth/Ground Protective Conductor Terminal
---	--	---	--	---	--

Safety Information



Hazards

DANGER! - Ignoring the following may result in injury

1. This equipment can endanger life by exposure to rotating machinery and high voltages.
2. The equipment must be permanently earthed due to the high earth leakage current, and the drive motor must be connected to an appropriate safety earth.
3. Ensure all incoming supplies are isolated before working on the equipment. Be aware that there may be more than one supply connection to the drive.
4. There may still be dangerous voltages present at power terminals (motor output, supply input phases, DC bus and the brake, where fitted) when the motor is at standstill or is stopped.
5. For measurements use only a meter to IEC 61010 (CAT III or higher). Always begin using the highest range. CAT I and CAT II meters must not be used on this product.
6. Allow at least 5 minutes for the drive's capacitors to discharge to safe voltage levels (<50V). Use the specified meter capable of measuring up to 1000V dc & ac rms to confirm that less than 50V is present between all power terminals and earth.
7. Unless otherwise stated, this product must NOT be dismantled. In the event of a fault the drive must be returned. Refer to "Routine Maintenance and Repair".

WARNING! - Ignoring the following may result in injury or damage to equipment

SAFETY

Where there is conflict between EMC and Safety requirements, personnel safety shall always take precedence.

- Never perform high voltage resistance checks on the wiring without first disconnecting the drive from the circuit being tested.
- Whilst ensuring ventilation is sufficient, provide guarding and /or additional safety systems to prevent injury or damage to equipment.
- When replacing a drive in an application and before returning to use, it is essential that all user defined parameters for the product's operation are correctly installed.
- All control and signal terminals are SELV, i.e. protected by double insulation. Ensure all external wiring is rated for the highest system voltage.
- Thermal sensors contained within the motor must have at least basic insulation.
- All exposed metalwork in the Inverter is protected by basic insulation and bonded to a safety earth.
- RCDs are not recommended for use with this product but, where their use is mandatory, only Type B RCDs should be used.

EMC

- In a domestic environment this product may cause radio interference in which case supplementary mitigation measures may be required.
- This equipment contains electrostatic discharge (ESD) sensitive parts. Observe static control precautions when handling, installing and servicing this product.
- This is a product of the restricted sales distribution class according to IEC 61800-3. It is designated as "professional equipment" as defined in EN61000-3-2. Permission of the supply authority shall be obtained before connection to the low voltage supply.

CAUTION!

APPLICATION RISK

- The specifications, processes and circuitry described herein are for guidance only and may need to be adapted to the user's specific application. We can not guarantee the suitability of the equipment described in this Manual for individual applications.

RISK ASSESSMENT

Under fault conditions, power loss or unintended operating conditions, the drive may not operate as intended.

In particular:

- Stored energy might not discharge to safe levels as quickly as suggested, and can still be present even though the drive appears to be switched off
- The motor's direction of rotation might not be controlled
- The motor speed might not be controlled
- The motor might be energised

A drive is a component within a drive system that may influence its operation or effects under a fault condition.

Consideration must be given to:

- Stored energy
- Supply disconnects
- Sequencing logic
- Unintended operation

Contents

Contents

Page

PROFIBUS-DP COMMUNICATIONS INTERFACE	1
A System Overview	1
The PROFIBUS Protocol	1
Principles of Operation	2
• I/O Data Exchange	2
Product Features	3
Product Code	3
Installation	4
Wiring the System	4
• Cable Specification	4
• Earthing the Shield (SCR)	5
• User Connections to the Main Serial Port (P1)	5
• Repeaters	5
• Terminators	5
6513 PROFIBUS Module - 650V Frames 1, 2 & 3	6
• Terminal Block Connections	6
• Network and Module LED Indications	7
• 24V DC Auxiliary Supply	7
6523 PROFIBUS Module - 650V Frames C, D, E & F	8
• Terminal Block Connections	8
• Network and Module LED Indications	9
Initial Set-up for Profibus	10
Initial Check for Connection	10
Configuring the Drive	10
• The COMMS PORTS Function Block	10
Configuring the PLC/SCADA Supervisor	11
The Network Interface	14
• PKW (Demand Data) Processing	14
• Command	14
• Parameter Value or Error Code	15
• Parameter Reference	15
• Profibus Specific Parameters	15
• Option Parameterisation Flags	17
ASCII Table	18
Decimal/Hexadecimal Table	19
Troubleshooting	22

PROFIBUS-DP COMMUNICATIONS INTERFACE

A System Overview

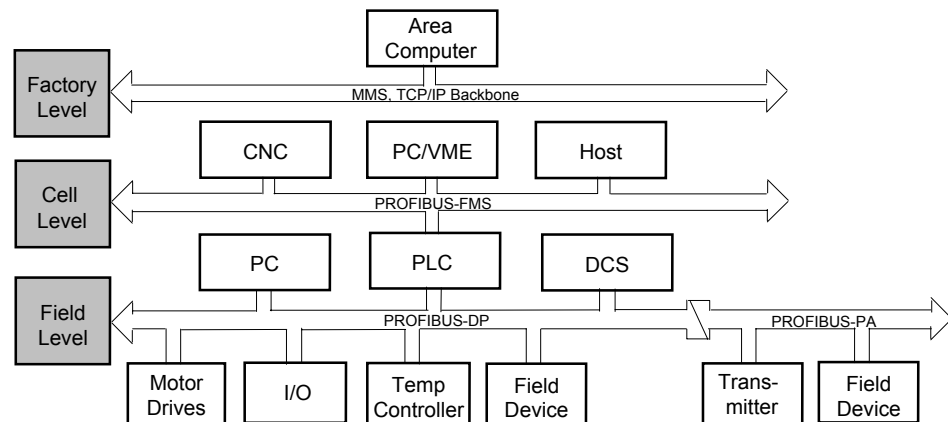

Figure 1 PROFIBUS Application Areas

The PROFIBUS Option supports the PROFIBUS-DP variant of the PROFIBUS protocol which is designed especially for communication between automatic control systems and distributed I/O at the device level. It is most often used to allow a central Programmable Logic Controller or PC based control system to use external 'slave' devices for I/O or specialised functions. The principal advantage is that these devices may be distributed around a machine, thereby saving on the cost of point to point wiring. The 'open' nature of the network also permits equipment from different manufacturers to be mixed on the same bus. Additionally, the off-loading of complex and specialised tasks such as PID temperature control lessens the processing load on the central PLC so that its other functions may be carried out more efficiently and require less CPU memory.

The PROFIBUS Protocol

PROFIBUS is a vendor independent, open fieldbus standard for a wide range of applications in manufacturing, process and building automation. Vendor independence and openness are guaranteed by the PROFIBUS standard EN50170. With PROFIBUS, devices from different manufacturers can inter-communicate. Suitable interfaces exist for PLCs, which include the Siemens, Mitsubishi and Allen Bradley range.

PROFIBUS-DP (De-central Periphery) is described in DIN 19245 Part 3, and forms part of EN 50170 with P-Net and WorldFIP. However it is important to note that P-Net and WorldFIP are *wholly incompatible* with PROFIBUS, using different wiring and transmission technologies.

The PROFIBUS-DP network uses a high speed version of the RS485 standard, permitting baud rates of up to 12Mbaud. A table of network speed against segment length is shown in page 4.

A maximum of 32 PROFIBUS-DP stations (nodes) may be contained within a single network segment. Use of RS485 repeaters allows a total of up to 126 stations.

PROFIBUS-DP is a multimaster, master-slave, token passing network. More detailed information, including a detailed guide to products available, may be obtained from the various world-wide PROFIBUS user organisations. You will find contact information in trade magazines or by reference to <http://www.profibus.com> on the World Wide Web.

PROFIBUS is available in two other types, aimed at different application areas, as follows:

1. **PROFIBUS-PA** is designed especially for process automation. It permits sensors and actuators to be connected on one common bus line even in intrinsically safe areas. PROFIBUS PA permits data communication and power over the bus, using intrinsically safe, 2-wire technology according to the international standard IEC 1158-2, but may also be used on the standard RS485 cabling for non-intrinsically safe applications.
2. **PROFIBUS-FMS** is the general purpose solution for communication tasks at the cell level.

Principles of Operation

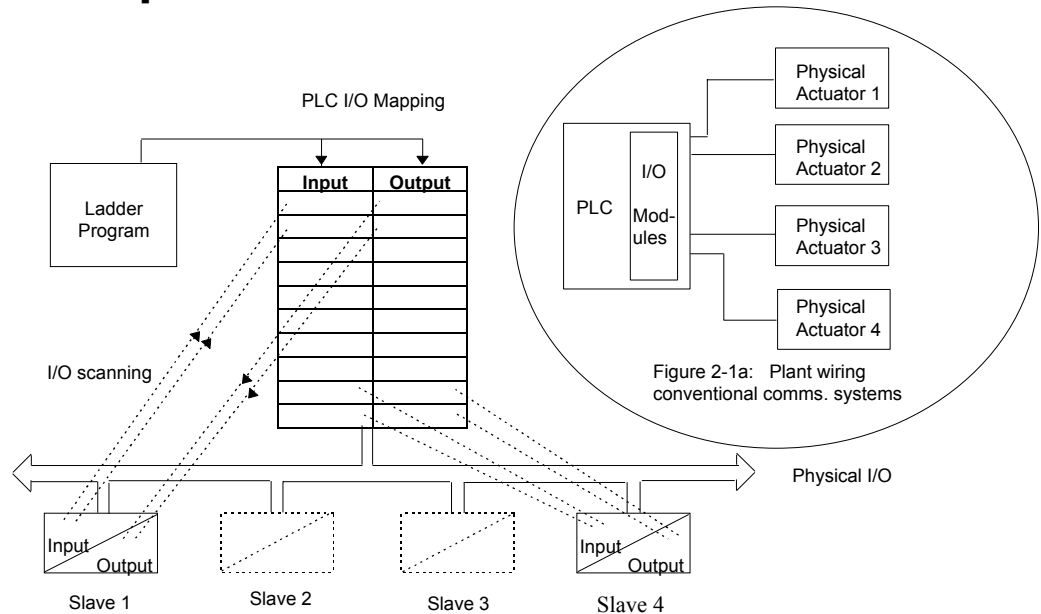

Figure 2 PROFIBUS compared with conventional comms. systems

PROFIBUS-DP distinguishes between master devices and slave devices. It allows slave devices to be connected on a single bus thus eliminating considerable plant wiring typical with conventional communications systems. The Figure above compares the two systems.

Master devices determine the data communication on the bus. A master can send messages without an external request when it holds the bus access rights (the token). Masters are also called active stations in the PROFIBUS protocol.

Slave devices are peripheral devices. Typical slave devices include input/output devices, valves, motor drives and measuring transmitters. The drives are intelligent slaves. This means they will only respond to a master when requested to do so.

PROFIBUS-DP is based around the idea of a ‘cyclical scan’ of devices on the network, during which ‘input’ and ‘output’ data for each device is exchanged.

I/O Data Exchange

The process of reading the inputs and writing to the outputs is known as an I/O data exchange. Typically, the parameters from each slave device will be mapped to an area of PLC input and output registers, or a single function block, so that the controlling ladder logic or program interfaces with the device as if it were an internally fitted module. It is NOT necessary, therefore, for the programmer to know anything about the physical network. The process of network configuration is usually performed using a PC based program which allows the devices on the network to be defined and device parameters to be mapped into the PLC registers or function blocks.

The cyclical scan occurs in the following order:

1. Values from each slave device, ‘Input Data’, are first scanned over the network into a pre-defined set of input registers in the master controller. Such values might be a set of digital input readings for a digital input unit, or the measured temperature and alarm status from a PID controller.
2. The master then runs its control program, (such as a ladder logic program) using the input data read from the slave devices.
3. The master writes output values (output data) into a pre-defined set of output registers. For example, one of the digital inputs read in the input data might be used to select one of a set of setpoints to be sent to the PID controller.
4. These outputs are then written to each slave device, and the scan-process-write cycle repeats.

Typically no more than 32 bytes of input data and 32 bytes of output data are exchanged for each device during the data exchange. Some PLC masters allow no more than this, although the

4

Installation

Wiring the System

WARNING!

Before installing, ensure that the drive and all wiring is electrically isolated and cannot be made "live" unintentionally by other personnel.

Wait 5 minutes after disconnecting power before working on any part of the system or removing the covers from the Drive.

The Profibus Technology Option is operated as a 2-wire system:

- A 2-wire system can only be used in a network in which all devices use their tri-state capability. Data flow is restricted, i.e. transmit and receive cannot be simultaneous (half duplex).

Note: *It is possible to make serial communications operate without adhering to the following recommendations, however, the recommendations will promote greater reliability.*

Cable Specification

Either of the two cable types detailed below can be used but we recommend Type A as it allows higher speed and longer cable length.

	Type A cable	Type B cable
Characteristic Impedance:	135 to 165Ω at a frequency of 3 to 20MHz.	135 to 165Ω at a frequency of >100kHz
Cable capacitance:	< 30pF per metre	typically <60pF per metre
Core diameter:	max. 0.34 mm ² , corresponds to AWG 22	maximum 0.22mm ² , corresponds to AWG24
Cable type:	twisted pair cable. 1x2 or 2x2 or 1x4 lines	twisted pair cable. 1x2 or 2x2 or 1x4 lines
Resistance:	< 110Ω per km	-
Shielding:	Copper shielding braid or shielding braid and shielding foil	Copper shielding braid or shielding braid and shielding foil

Note: *Belden B3079A cable meets the above specification for Type A, but there are others.*

Maximum Line Length Per Segment

Baud rate (kbit/sec)	9.6	19.2	93.75	187.5	500	1500
Type A cable	1200m	1200m	1200m	1000m	400m	200m
Type B cable	1200m	1200m	1200m	600m	200m	-

Earthing the Shield (SCR)

The PROFIBUS standard suggests that both ends of the transmission line should be connected to safety earth. If you do this, ensure that differences in local earth potential do not allow circulating currents to flow, as not only can these induce large common mode signals in the data lines, but they can also produce potentially dangerous heating in the cable. If in doubt, earth the shield at only one section of the network.

User Connections to the Main Serial Port (P1)

The serial port on the Option allows the following Profibus links to be made.

	Profibus
Electrical Connections	2-wire differential
Number of transmitters and transceivers allowed per differential pair of wires	32 transceivers
Maximum cable length	4000ft/1200 metres

Repeaters

RTS (Terminal 5) is a TTL level signal that can be connected to a repeater. Most repeaters automatically switch between transmitting and receiving and so do not need this connection.

Terminators

Terminating resistors must be fitted to the first and last devices in the system. A "device" may be a drive or PC/PLC.

- If the device is at the front of the network it must have terminating resistors.
- If the device is at the end of the network it must have terminating resistors.
- All other devices in the system should not have terminators.

Connect terminating resistors to the drive as shown below. (All resistors $\pm 5\%$, minimum $\frac{1}{4}$ Watt).

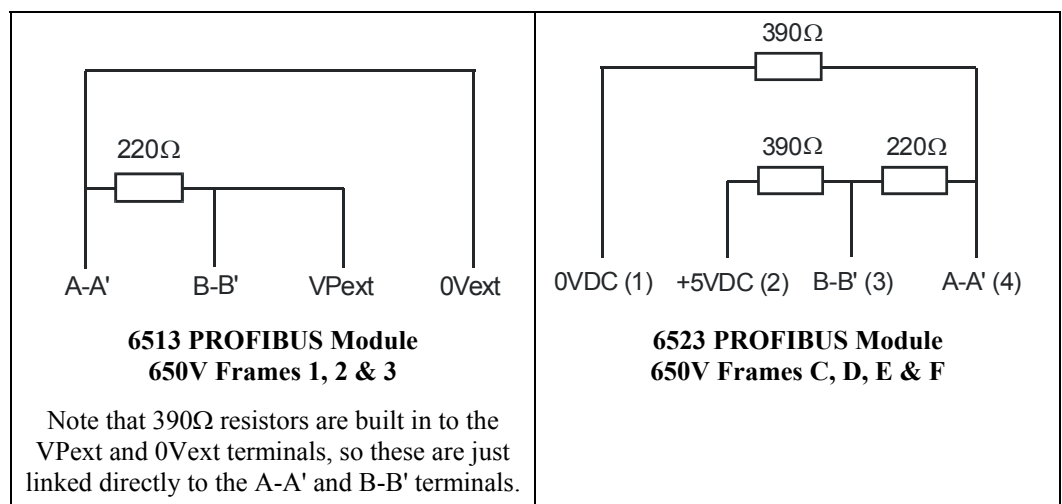

6513 PROFIBUS Module - 650V Frames 1, 2 & 3

You can create a network of drives by linking a Master (PC/PLC) to one or more drives fitted with this module. Plug this Communication Module on to the front of the drive, replacing the keypad. It converts signals from the host drive into PROFIBUS, and vice versa, so that information can be shared between the Master and 650V drive(s).

Wiring is very simple - all connections are SELV (Safe Extra Low Voltage). The module must be grounded to the system earth using an earth terminal on the drive.

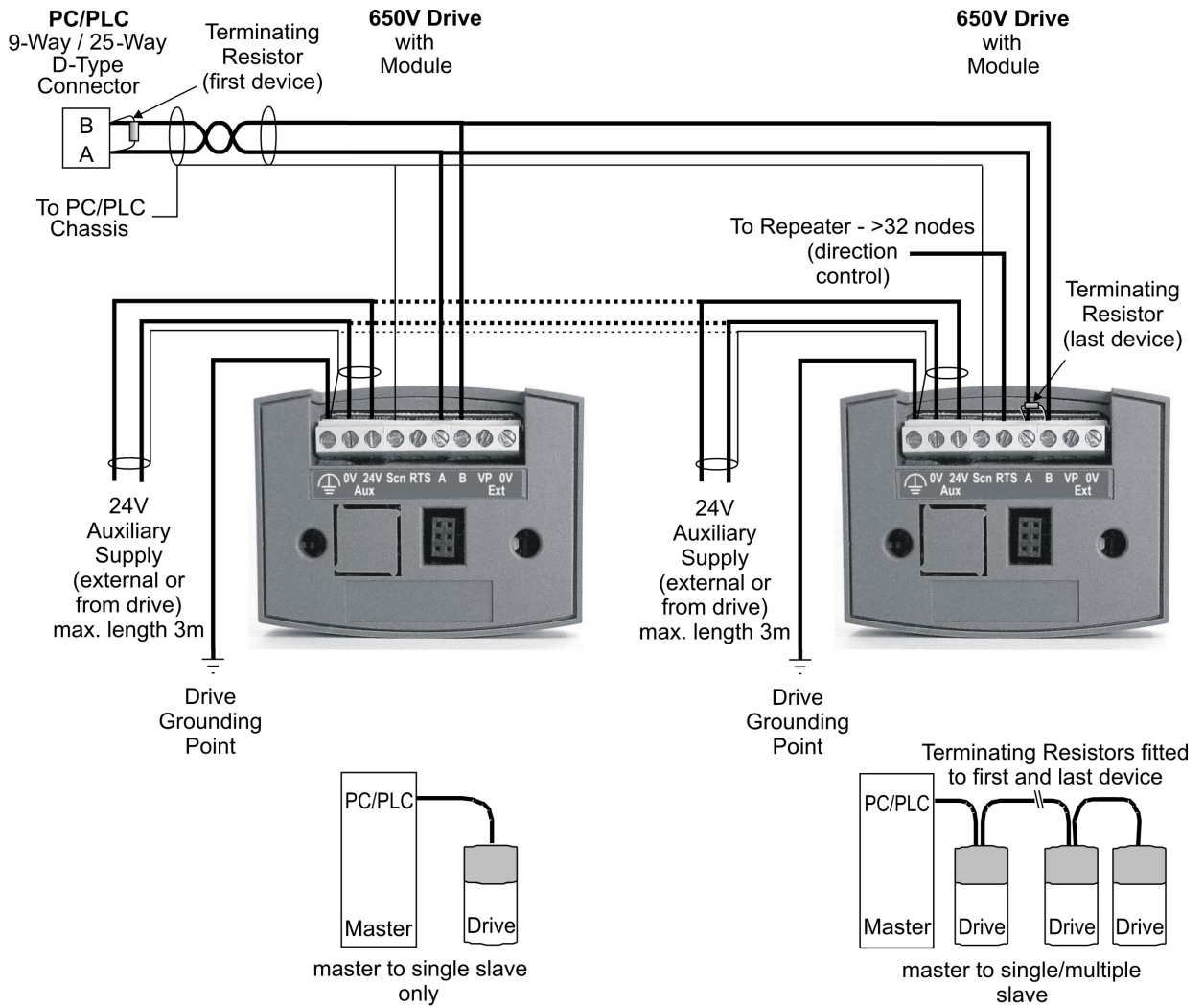

Note: To conform to EMC limits, the 24V Auxiliary Supply cable must not exceed 3 metres in total length (whether supplying single or multiple, "daisy-chained" drives). The cable must be screened and connected at one end only via the module's Ground terminal, \perp .

Terminal Block Connections

Terminal	Reference	Meaning
\perp	Ground	Ground connection for EMC, connect to earth
0V Aux	0V Auxiliary	Auxiliary power supply
24V Aux	24V Auxiliary	Auxiliary power supply
Scn	Screen	Screen connection
RTS	RTS	For connection to a repeater (TTL)
A	A-A'	Receive/Transmit Data Negative
B	B-B'	Receive/Transmit Data Positive
VP Ext	+5VDC External	+5VDC ext (20mA) supply for PROFIBUS terminators
0V Ext	0V External	0VDC ext supply for PROFIBUS terminators

Network and Module LED Indications

650V Frames 1, 2 & 3

The module has three LEDs providing diagnostic information about the host drive's 'Health', 'Network' and 'Module' activity.

The Health LED is explained in the Product Manual.

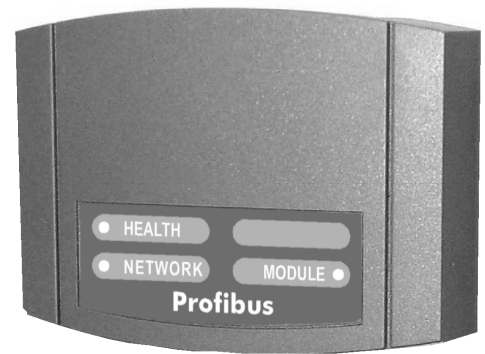

		Network LED	Module LED	
		Indicates the state of the connected network.	Indicates the set-up state of the Module. The states indicated are those produced by the FAULT parameter of the TEC OPTION function block.	
LED Indication		Description	FAULT Parameter	Description
OFF		Disabled or Baud search	HARDWARE	Hardware Fault - external
SHORT FLASH		Wait Parameterisation	SELF TEST	Hardware fault - internal
FLASH		Wait Configuration		
LONG FLASH		Data exchange with error	PARAMETER	Set-up fault, parameter values out-of-range
ON		Data exchange	NONE	Valid set-up, ready for external communications

Note: The NETWORK LED is always in the OFF state when the MODULE LED is *not* ON continuously, indicating that the Option is not ready for external communications.

24V DC Auxiliary Supply

The Module requires an auxiliary supply. This can be supplied from the drive via terminal 6 (+24V) and Terminal 1 (0V), or from a separate customer supply.

Each PROFIBUS module has a current requirement of 40mA. If daisy-chaining these connections, note the current loading on the drive's internal supply (terminal 6). Do not overload this supply. Refer to the Product Manual for details.

6523 PROFIBUS Module - 650V Frames C, D, E & F

Note: The PROFIBUS module can only be fitted to 650V Frames C, D, E & F drives that are shipped from the factory with Version 4.9 software onwards. These drives are fitted with an earthing strap on the control board that is used to secure and correctly earth the PROFIBUS module via the Captive Screw.

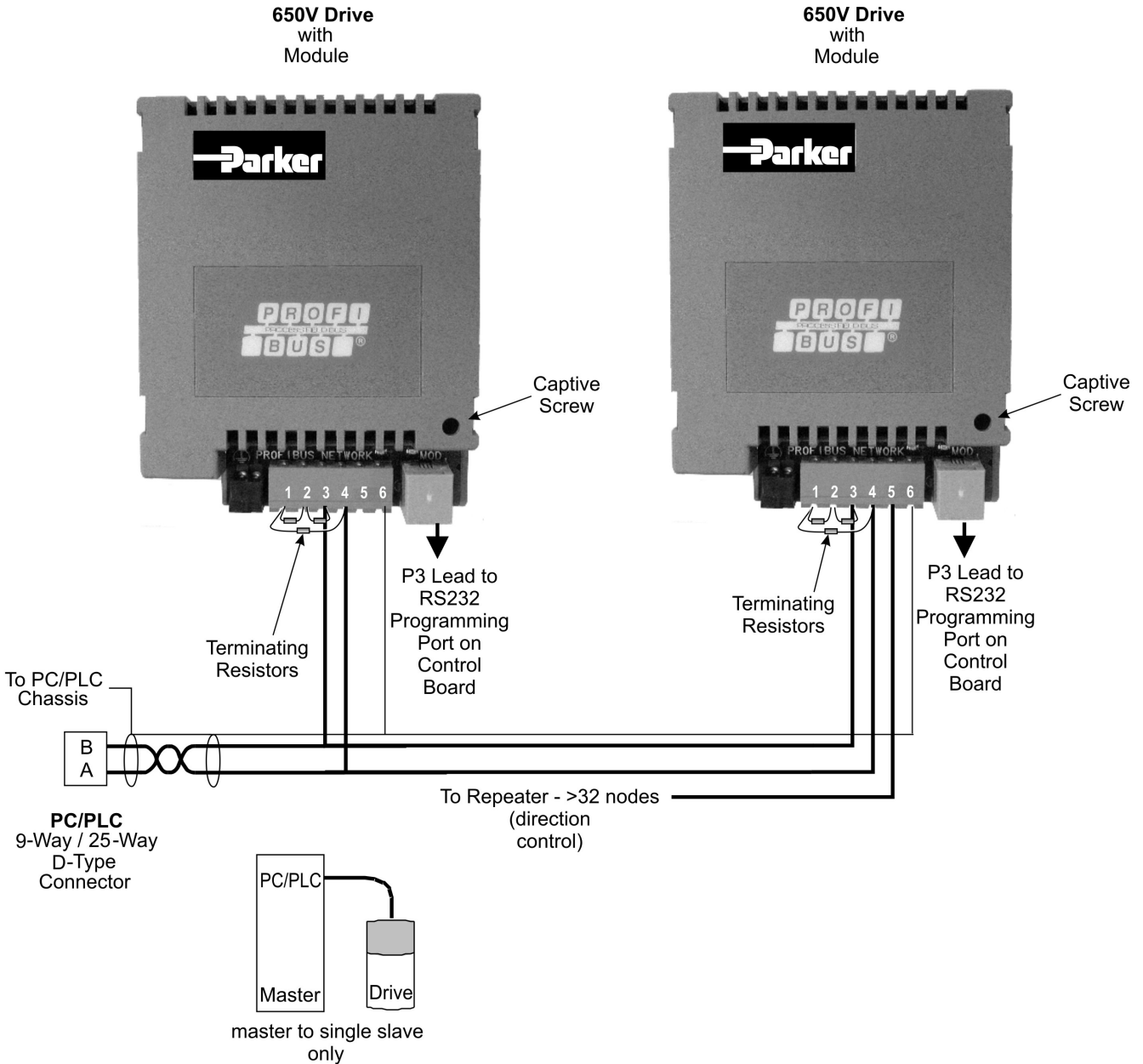

Terminal Block Connections





Terminal	Reference	Meaning
1	0V External	0VDC ext supply for PROFIBUS terminators
2	+5VDC External	+5VDC ext (20mA) supply for PROFIBUS terminators
3	B-B'	Receive/Transmit Data Positive
4	A-A'	Receive/Transmit Data Negative
5	RTS	For connection to a repeater (TTL)
6	Screen	Screen connection
P3	P3	RS232 connection to drive P3 Lead Part Number: CM057375U009
-	Captive Screw	Mechanical mounting and earthing point

Network and Module LED Indications

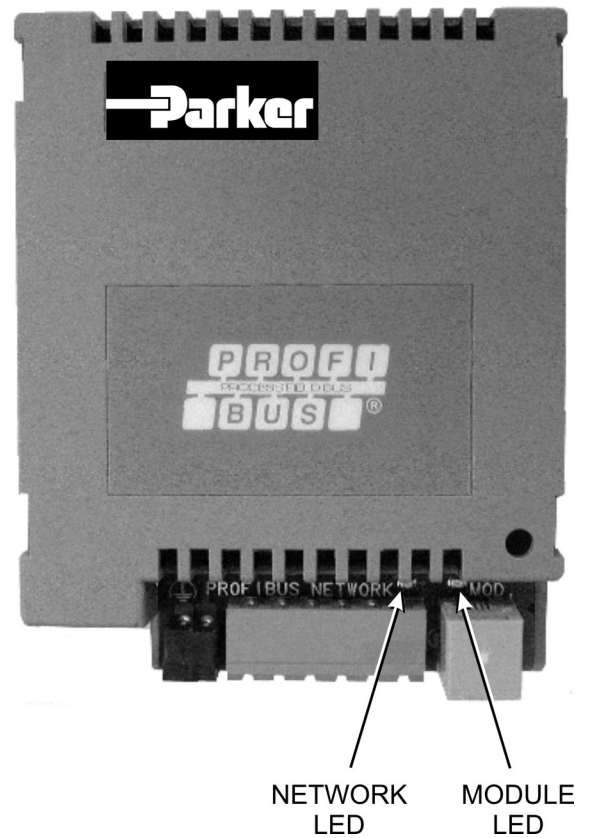
650V Frames C, D E & F

The module has two LEDs providing information about the Network and Module state.





Network LED		Module LED	
Indicates the state of the connected network.		Indicates the set-up state of the Module. The states indicated are those produced by the FAULT parameter of the TEC OPTION function block.	
LED Indication	Description	FAULT Parameter	Description
OFF 	Disabled or Baud search	HARDWARE	Hardware Fault - external
SHORT FLASH 	Wait Parameterisation	SELF TEST	Hardware fault - internal
FLASH 	Wait Configuration		
LONG FLASH 	Data exchange with error	PARAMETER	Set-up fault, parameter values out-of-range
ON 	Data exchange	NONE	Valid set-up, ready for external communications

Note: The NETWORK LED is always in the OFF state when the MODULE LED is **not ON** continuously, indicating that the Module is not ready for external communications.

Initial Set-up for Profibus

Initial Check for Connection

With the correct connections to the active PLC/SCADA supervisor, the MODULE LED will be ON continuously and the NETWORK LED will indicate the idle state with a short flash.

ON		MODULE LED
SHORT FLASH		NETWORK LED

Configuring the Drive

Using the Operator Station (MMI) or other suitable PC programming tool, the COMMS PORTS function block requires configuring before the PROFIBUS option can be used.

DSE is Parker SSD Drives' Windows-based block programming software.

The COMMS PORTS Function Block

The COMMS PORTS function block contains the following parameter names when viewed using the MMI.

Below are the parameters that require setting.

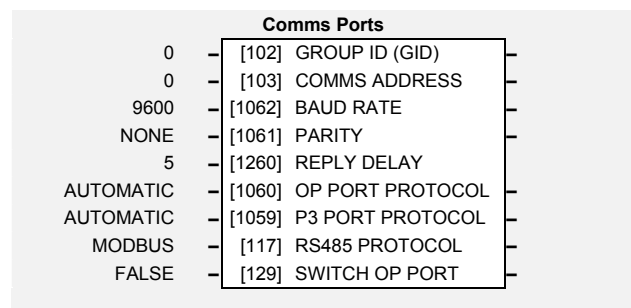

Parameter Descriptions

COMMS ADDRESS  *SET\SERL SE03* Range: 0 to 255

Set to a unique address (each drive should use a different number). Set to a value between 1 and 125. Note that addresses 0, 1 and 2 are usually reserved for PROFIBUS Masters and so should be avoided.

This parameter is the Parker SSD Drives protocol unit identity. This also sets the address for any other comms ports on the drive.

P3 PORT PROTOCOL  *SET\SERL SE08* Range: Enumerated - see below

650V Frames C, D, E & F : Set to FIELDBUS.

Selects the protocol to be used by the RS232 programming port on the drive's control board. When EIBISYNC ASCII is selected, BAUD RATE is 19200 and PARITY is EVEN.

Enumerated Value : Protocol

- 0 : AUTOMATIC - checks for keypad or EI ASCII
- 1 : KEYPAD
- 2 : EIBISYNC ASCII
- 3 : MODBUS
- 4 : FIELDBUS

OP PORT PROTOCOL  *SET\SERL SE07* Range: Enumerated - see below

650V Frames 1, 2 & 3 : Set to FIELDBUS.

Selects the protocol to be used by the keypad port on the front of the drive. When EIBISYNC ASCII is selected, BAUD RATE is 19200 and PARITY is EVEN.

Enumerated Value : Protocol

- 0 : AUTOMATIC - checks for keypad or EI ASCII
- 1 : KEYPAD
- 2 : EIBISYNC ASCII
- 3 : MODBUS
- 4 : FIELDBUS

Configuring the PLC/SCADA Supervisor

Note: This example uses the Siemens Simatic 7 PROFIBUS configuration tool, Siemens STEP 7 Simatic manager.

1. Create a project selecting the PLC hardware to be used. Click on Hardware...

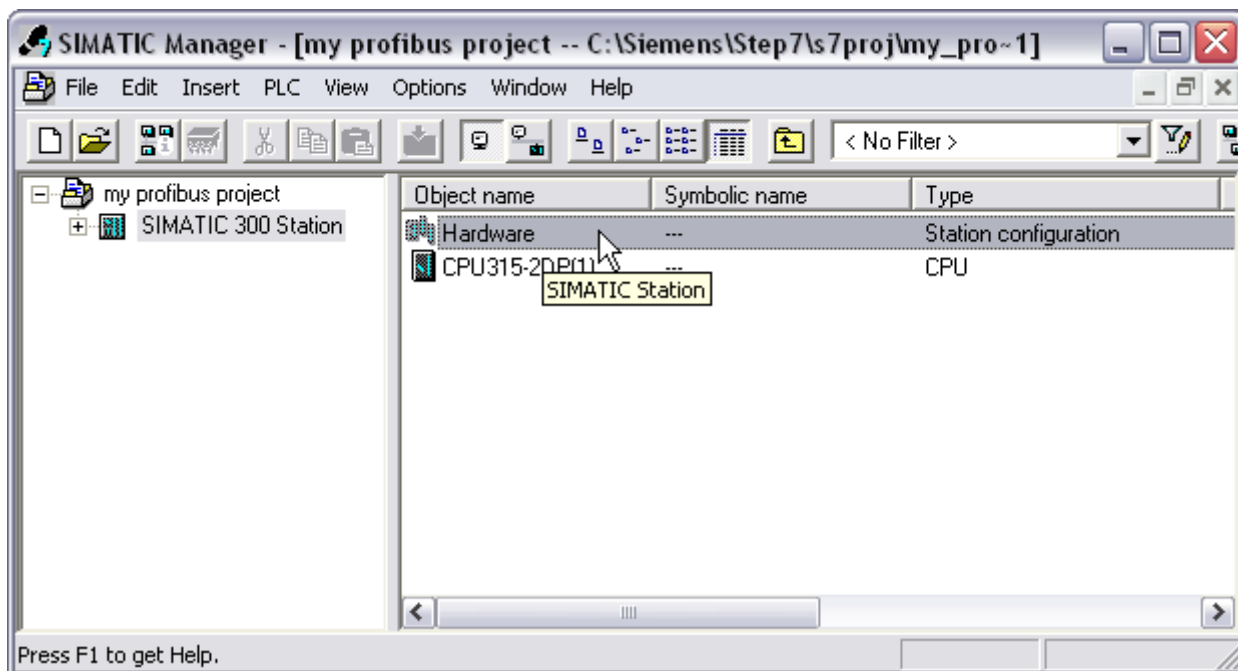

2. Import the GSD file for the drive so that it appears in the Hardware Catalog. Click on **Options...Install New GSD...**, then use the file explorer to select the file.

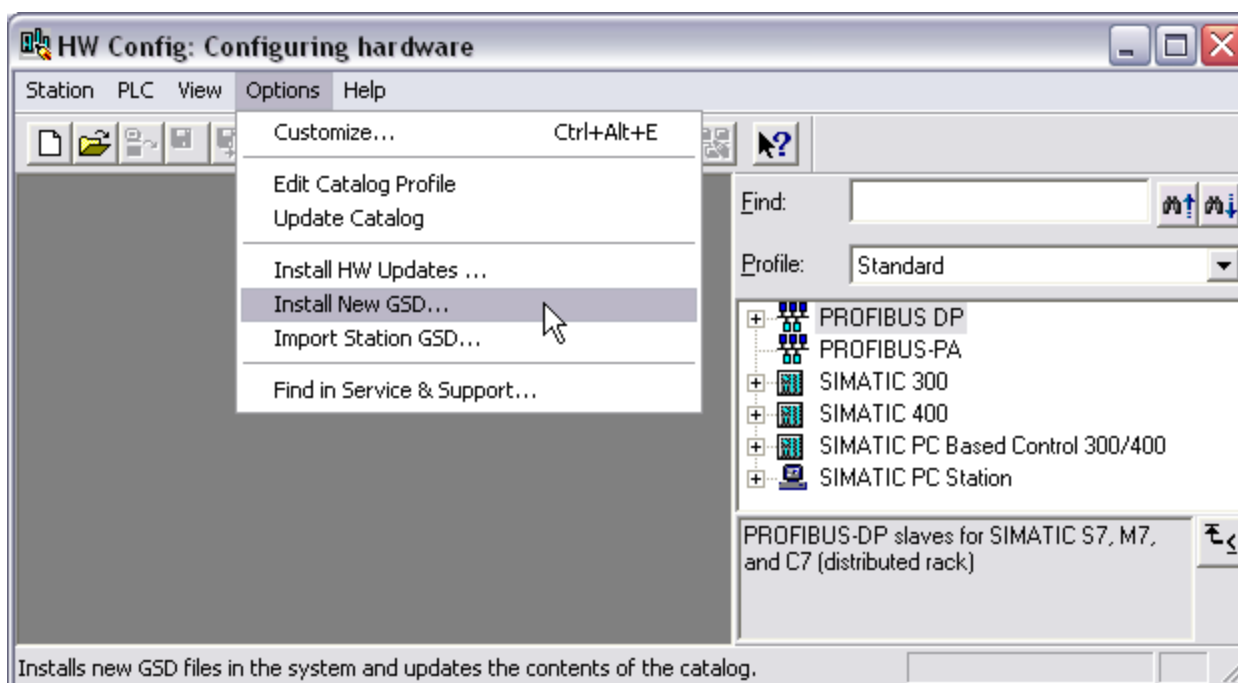

3. Open the project for the Profibus Master. Find the Device Description for the Parker **SSD Drives 650V** which can be found under **PROFIBUS DP:Additional Field Devices: Drives: SSD Drives** in the Hardware Catalog window. Select with the mouse and drag across to the DP Master in the station window. The required node address for the drive must be entered when prompted.

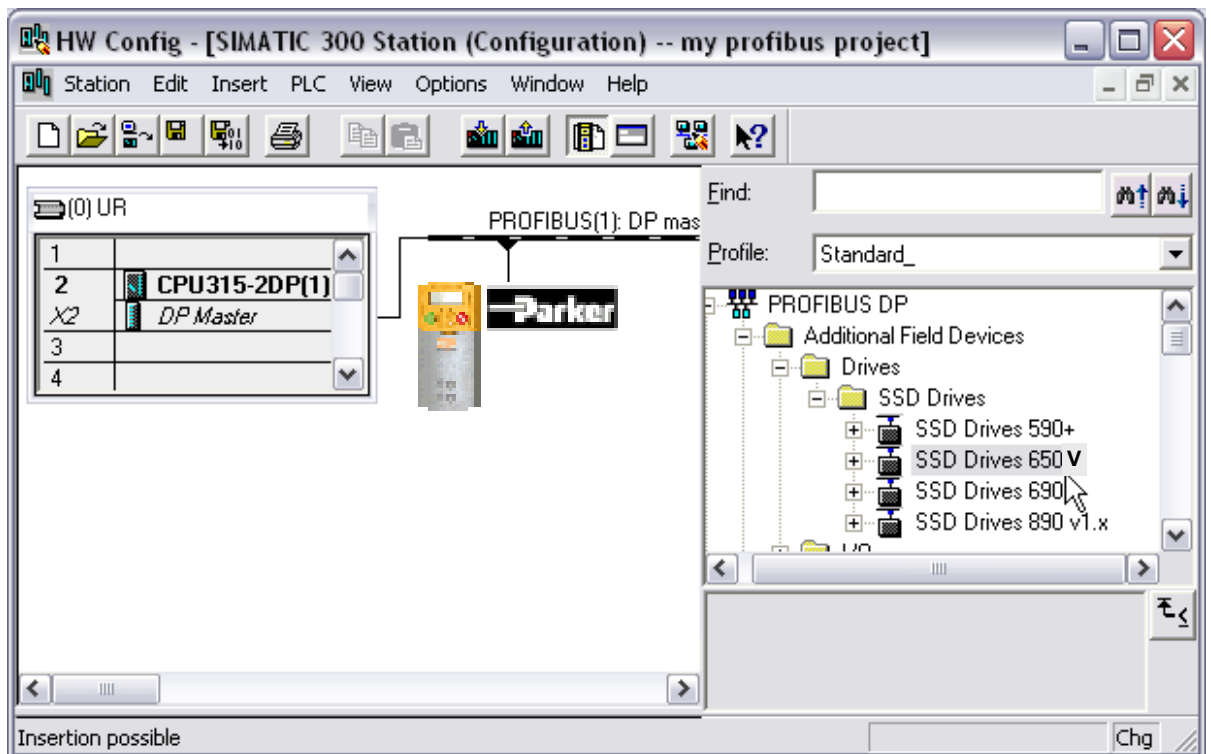

4. Configure which drive parameters are to be exchanged with the Master. These are picked from the drive in the Hardware Catalog window. First click on the 650V icon in the Station window to open the register list for this node in the lower Station window. Select the required module in the Hardware Catalog window and then click or drag to the lower Station window.

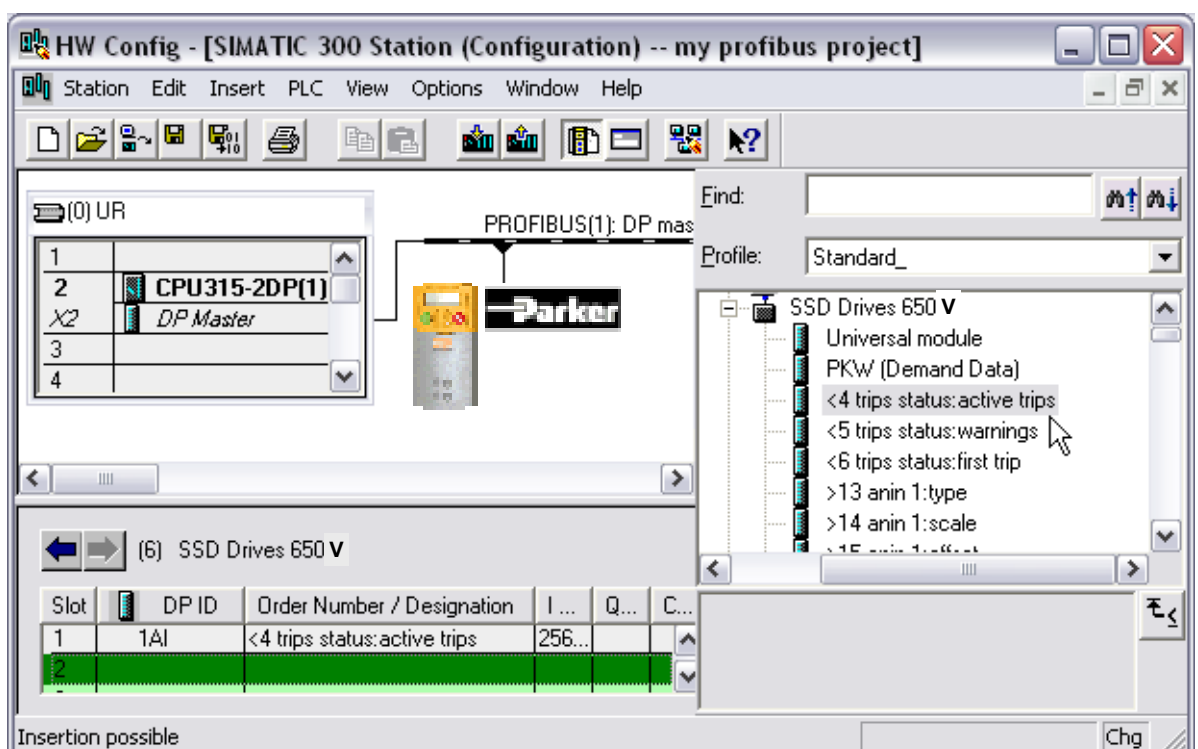

Two types of module can be selected:

1 : PKW (Demand data)

This is to enable cyclic data transfer via the PKW mechanism as defined by PROFIDRIVE V0.

Refer to page 14.

Note: If this feature is required, it must be the first module declared.

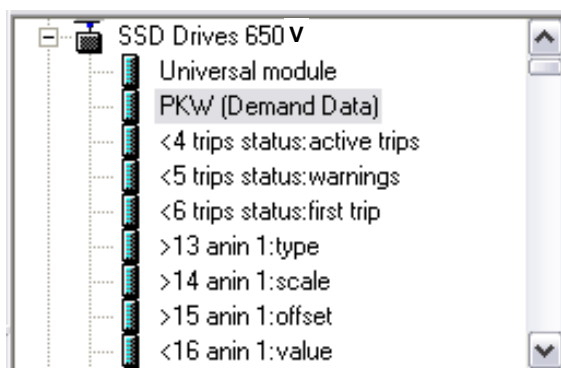

2 : Drive Parameters

Select from the list of parameters to add to the input and output data. For example, adding parameter ">271 comms ctrl:comms command in" adds the COMMS COMMAND parameter (tag 271) to the Output Data from the PLC.

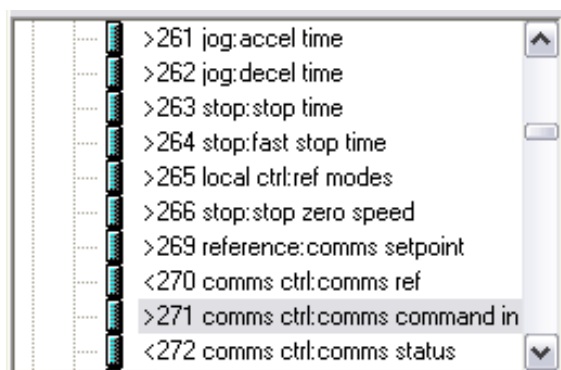

3 : Floating Point Format

Some parameters are available in IEEE floating point format as well as standard 16-bit scaled integers. When adding these parameters to the Output Data from the PLC, be sure to only select the parameter once. The floating point format is indicated by a double chevron ">>" for inputs to the drive, "<<" for outputs from the drive.

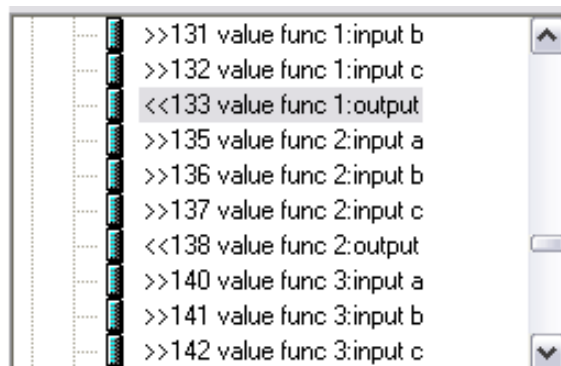

A combination of the above module types may be included, for example:

Slot	DP ID	Order Number / Designation	I Address	Q Addr...	Comment
1	115	PKW (Demand Data)	256...263	256...263	
2	1AI	<4 trips status:active trips	264...265		
3	1AI	<255 reference:speed demand	266...267		
4	1AI	<272 comms ctrl:comms status	268...269		
5	1AO	>271 comms ctrl:comms command in		264...265	
6	1AO	>269 reference:comms setpoint		266...267	
7	209	<<133 value func 1:output	270...273		
8					

The Network Interface

PKW (Demand Data) Processing

PKW is a sub-protocol using the first 8 bytes (octets) in both the request and response message of the cyclic Data Exchange. It allows random read/write access to any parameter within the Drive. It is enabled by the Profibus-DP- Master setting the first byte of the Cfg_Data to 0x73. A PKW module is contained in the GSD file installed when configuring the PLC/SCADA Supervisor.

The sub-protocol consists of 3 parts:

- **Command**
- **Parameter Reference**
- **Parameter Value or Error Code**

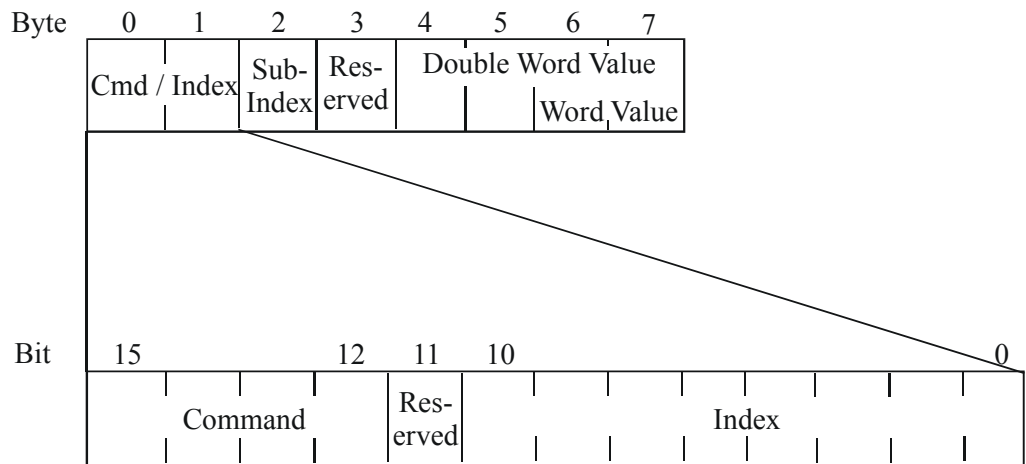

Command

The Command field in the request message selects the required operation. This is either None, Read, Write Word, or Write Double Word.

The Command field in the response message either confirms that no operation has been requested, indicates that a Read or Write request has been completed successfully or indicates that a Read or Write request has failed.

Valid values for the Command field are:

Command	Request (Master to Slave)	Positive Response (Slave to Master)
0	No Command	0
1	Read Request	1 or 2
2	Write Word Request	1

The valid Response Codes are:

Response	Meaning
0	No Response
1	Transfer Word
2	Transfer Double Word
4	Transfer Word (array)
5	Transfer Double Word (array)
7	Request Rejected with error code

Parameter Value or Error Code

The Value/Error Code field is used to receive a Read value, send a Write value or receive an error code.

The Value is either a Word (16-bit) or a Double Word (32-bit):

- ◆ If a Word, the value is transferred in octets 6 and 7 of the request and/or response
- ◆ If a Double Word, the value is transferred in octets 4, 5, 6 and 7.

If the Response Command is 7, i.e. the request has been rejected, this field contains the error code. These are:

Error Code	Meaning
0	Invalid Tag Number
1	Read Only Parameter
2	Value Under/Over-Range
3	Incorrect Data Type
17	Request cannot be processed because of operating state
18	Other error

Parameter Reference

The Parameter Reference is the parameter tag number in the drive. A list of tag numbers may be found for each drive type in the drive software manual. This may be downloaded from the Parker SSD Drives web site.

Profibus Specific Parameters

The following parameters are specific to the Profibus Option.

Tag	Description	Range (HEX values)	Access
901	Instrument Identity	1650 or 2650 1650 = 650V Frames 1, 2 & 3 2650 = 650V Frames C, D, E & F	Read Only
902	Main Software Version	0000 to FFFF	Read Only
903	6051 Software Version	0000 to FFFF (0000 if not fitted)	Read Only
908	Bootloader Software Version	0000 to FFFF	Read Only
909	Last Tag Number	0000 to FFFF	Read Only
911	Command	see below (!1)	Write Only
912	State	see below (!2)	Read Only
913	Save Command	see below (!3)	Write Only
914	Save State	see below (!4)	Read Only
920	Profibus Option Firmware Version	0101 : Version 1.1	Read Only
921	Profibus Option Error Information	0000 to FFFF : indicates the Tag number of the last parameter that could not be written to or read from the drive.	Read Only

!1 : Command	
Write-only: used to modify the state of the drive and to load configuration data from non-volatile memory.	
HEX Value	Description
7777	Reset Command. Acknowledges failed restore. Loads and saves default Product Code and default Configuration (Application 1).
0101	Restores Saved Configuration from drive's non-volatile memory.
0110	Restores Default Configuration (Application 0)
0111	Restores Default Configuration (Application 1)
0112	Restores Default Configuration (Application 2)
0113	Restores Default Configuration (Application 3)
0114	Restores Default Configuration (Application 4)
0115	Restores Default Configuration (Application 5)
4444	Exit Configuration Mode
5555	Enter Configuration Mode

!2 : State	
Read-only: used to determine the major state of the drive.	
HEX Value	Description
0000	Initialising. (Powering up)
0001	Corrupted Product Code and Configuration
0002	Corrupted Configuration
0003	Restoring Configuration
0004	Re-Configuring Mode
0005	Normal Operation Mode

!3 : Save Command	
Write-only: used to save the configuration and product code in non-volatile memory.	
HEX Value	Description
0000	Reset Command. Acknowledges (clears) any previous save error.
0001	Saves Configuration to drive's non-volatile memory.
0100	Saves Product Code to drive's non-volatile memory.

!4 : Save State	
Read only: used to determine the progress of a non-volatile saving operation.	
HEX Value	Description
0000	Idle
0001	Saving
0002	Failed

Option Parameterisation Flags

The Profibus option supports two special parameterisation flags. These are contained in the fourth byte of the parameterisation data.

Parameterisation flags bit 0: Ignore network failure

Default value FALSE.

This flag determines the action of the Profibus option in the event of a network failure, (such as a broken network cable). When this flag is FALSE, the option will set all the cyclic data exchange parameters to be zero on a network failure. When this flag is TRUE, the option will leave these parameters unchanged.

WARNING!

Modifying this flag may cause the drive to continue running after a network failure.

Parameterisation flags bit 1: Byte swap

Default value FALSE.

This flag determines the byte order of data exchanged with the Profibus master. When this flag is FALSE, data is exchanged in little endian format. When this flag is TRUE, data is exchanged in big endian format.

ASCII Table												
BINARY				b ₆	0	0	0	0	1	1	1	1
				b ₅	0	0	1	1	0	0	1	1
				b ₄	0	1	0	1	0	1	0	1
b ₃	b ₂	b ₁	b ₀	HEX	0x	1	2	3	4	5	6	7
0	0	0	0	x0	NUL	DLE	SP	0	@	P	`	p
0	0	0	1	1	SOH	DC ₁	!	1	A	Q	a	q
0	0	1	0	2	STX	DC ₂	"	2	B	R	b	r
0	0	1	1	3	ETX	DC ₃	#	3	C	S	c	s
0	1	0	0	4	EOT	DC ₄	\$	4	D	T	d	t
0	1	0	1	5	ENQ	NAK	%	5	E	U	e	u
0	1	1	0	6	ACK	SYN	&	6	F	V	f	v
0	1	1	1	7	BEL	ETB	'	7	G	W	g	w
1	0	0	0	8	BS	CAN	(8	H	X	h	x
1	0	0	1	9	HT	EM)	9	I	Y	i	y
1	0	1	0	A	LF	SUB	*	:	J	Z	j	z
1	0	1	1	B	VT	ESC	+	;	K	[k	{
1	1	0	0	C	FF	FS	,	<	L	\	l	
1	1	0	1	D	CR	GS	-	=	M]	m	}
1	1	1	0	E	SO	RS	.	>	N	^	n	~
1	1	1	1	F	SI	US	/	?	O	_	o	DEL

Decimal/Hexadecimal Table

	0	1	2	3	4	5	6	7	8	9
0	0000	0001	0002	0003	0004	0005	0006	0007	0008	0009
10	000A	000B	000C	000D	000E	000F	0010	0011	0012	0013
20	0014	0015	0016	0017	0018	0019	001A	001B	001C	001D
30	001E	001F	0020	0021	0022	0023	0024	0025	0026	0027
40	0028	0029	002A	002B	002C	002D	002E	002F	0030	0031
50	0032	0033	0034	0035	0036	0037	0038	0039	003A	003B
60	003C	003D	003E	003F	0040	0041	0042	0043	0044	0045
70	0046	0047	0048	0049	004A	004B	004C	004D	004E	004F
80	0050	0051	0052	0053	0054	0055	0056	0057	0058	0059
90	005A	005B	005C	005D	005E	005F	0060	0061	0062	0063
100	0064	0065	0066	0067	0068	0069	006A	006B	006C	006D
110	006E	006F	0070	0071	0072	0073	0074	0075	0076	0077
120	0078	0079	007A	007B	007C	007D	007E	007F	0080	0081
130	0082	0083	0084	0085	0086	0087	0088	0089	008A	008B
140	008C	008D	008E	008F	0090	0091	0092	0093	0094	0095
150	0096	0097	0098	0099	009A	009B	009C	009D	009E	009F
160	00A0	00A1	00A2	00A3	00A4	00A5	00A6	00A7	00A8	00A9
170	00AA	00AB	00AC	00AD	00AE	00AF	00B0	00B1	00B2	00B3
180	00B4	00B5	00B6	00B7	00B8	00B9	00BA	00BB	00BC	00BD
190	00BE	00BF	00C0	00C1	00C2	00C3	00C4	00C5	00C6	00C7
200	00C8	00C9	00CA	00CB	00CC	00CD	00CE	00CF	00D0	00D1
210	00D2	00D3	00D4	00D5	00D6	00D7	00D8	00D9	00DA	00DB
220	00DC	00DD	00DE	00DF	00E0	00E1	00E2	00E3	00E4	00E5
230	00E6	00E7	00E8	00E9	00EA	00EB	00EC	00ED	00EE	00EF
240	00F0	00F1	00F2	00F3	00F4	00F5	00F6	00F7	00F8	00F9
250	00FA	00FB	00FC	00FD	00FE	00FF	0100	0101	0102	0103
260	0104	0105	0106	0107	0108	0109	010A	010B	010C	010D
270	010E	010F	0110	0111	0112	0113	0114	0115	0116	0117
280	0118	0119	011A	011B	011C	011D	011E	011F	0120	0121
290	0122	0123	0124	0125	0126	0127	0128	0129	012A	012B
300	012C	012D	012E	012F	0130	0131	0132	0133	0134	0135
310	0136	0137	0138	0139	013A	013B	013C	013D	013E	013F
320	0140	0141	0142	0143	0144	0145	0146	0147	0148	0149
330	014A	014B	014C	014D	014E	014F	0150	0151	0152	0153
340	0154	0155	0156	0157	0158	0159	015A	015B	015C	015D
350	015E	015F	0160	0161	0162	0163	0164	0165	0166	0167
360	0168	0169	016A	016B	016C	016D	016E	016F	0170	0171
370	0172	0173	0174	0175	0176	0177	0178	0179	017A	017B
380	017C	017D	017E	017F	0180	0181	0182	0183	0184	0185
390	0186	0187	0188	0189	018A	018B	018C	018D	018E	018F
400	0190	0191	0192	0193	0194	0195	0196	0197	0198	0199
410	019A	019B	019C	019D	019E	019F	01A0	01A1	01A2	01A3
420	01A4	01A5	01A6	01A7	01A8	01A9	01AA	01AB	01AC	01AD
430	01AE	01AF	01B0	01B1	01B2	01B3	01B4	01B5	01B6	01B7
440	01B8	01B9	01BA	01BB	01BC	01BD	01BE	01BF	01C0	01C1
450	01C2	01C3	01C4	01C5	01C6	01C7	01C8	01C9	01CA	01CB
460	01CC	01CD	01CE	01CF	01D0	01D1	01D2	01D3	01D4	01D5
470	01D6	01D7	01D8	01D9	01DA	01DB	01DC	01DD	01DE	01DF
480	01E0	01E1	01E2	01E3	01E4	01E5	01E6	01E7	01E8	01E9
490	01EA	01EB	01EC	01ED	01EE	01EF	01F0	01F1	01F2	01F3

Decimal/Hexadecimal Table

	0	1	2	3	4	5	6	7	8	9
500	01F4	01F5	01F6	01F7	01F8	01F9	01FA	01FB	01FC	01FD
510	01FE	01FF	0200	0201	0202	0203	0204	0205	0206	0207
520	0208	0209	020A	020B	020C	020D	020E	020F	0210	0211
530	0212	0213	0214	0215	0216	0217	0218	0219	021A	021B
540	021C	021D	021E	021F	0220	0221	0222	0223	0224	0225
550	0226	0227	0228	0229	022A	022B	022C	022D	022E	022F
560	0230	0231	0232	0233	0234	0235	0236	0237	0238	0239
570	023A	023B	023C	023D	023E	023F	0240	0241	0242	0243
580	0244	0245	0246	0247	0248	0249	024A	024B	024C	024D
590	024E	024F	0250	0251	0252	0253	0254	0255	0256	0257
600	0258	0259	025A	025B	025C	025D	025E	025F	0260	0261
610	0262	0263	0264	0265	0266	0267	0268	0269	026A	026B
620	026C	026D	026E	026F	0270	0271	0272	0273	0274	0275
630	0276	0277	0278	0279	027A	027B	027C	027D	027E	027F
640	0280	0281	0282	0283	0284	0285	0286	0287	0288	0289
650	028A	028B	028C	028D	028E	028F	0290	0291	0292	0293
660	0294	0295	0296	0297	0298	0299	029A	029B	029C	029D
670	029E	029F	02A0	02A1	02A2	02A3	02A4	02A5	02A6	02A7
680	02A8	02A9	02AA	02AB	02AC	02AD	02AE	02AF	02B0	02B1
690	02B2	02B3	02B4	02B5	02B6	02B7	02B8	02B9	02BA	02BB
700	02BC	02BD	02BE	02BF	02C0	02C1	02C2	02C3	02C4	02C5
710	02C6	02C7	02C8	02C9	02CA	02CB	02CC	02CD	02CE	02CF
720	02D0	02D1	02D2	02D3	02D4	02D5	02D6	02D7	02D8	02D9
730	02DA	02DB	02DC	02DD	02DE	02DF	02E0	02E1	02E2	02E3
740	02E4	02E5	02E6	02E7	02E8	02E9	02EA	02EB	02EC	02ED
750	02EE	02EF	02F0	02F1	02F2	02F3	02F4	02F5	02F6	02F7
760	02F8	02F9	02FA	02FB	02FC	02FD	02FE	02FF	0300	0301
770	0302	0303	0304	0305	0306	0307	0308	0309	030A	030B
780	030C	030D	030E	030F	0310	0311	0312	0313	0314	0315
790	0316	0317	0318	0319	031A	031B	031C	031D	031E	031F
800	0320	0321	0322	0323	0324	0325	0326	0327	0328	0329
810	032A	032B	032C	032D	032E	032F	0330	0331	0332	0333
820	0334	0335	0336	0337	0338	0339	033A	033B	033C	033D
830	033E	033F	0340	0341	0342	0343	0344	0345	0346	0347
840	0348	0349	034A	034B	034C	034D	034E	034F	0350	0351
850	0352	0353	0354	0355	0356	0357	0358	0359	035A	035B
860	035C	035D	035E	035F	0360	0361	0362	0363	0364	0365
870	0366	0367	0368	0369	036A	036B	036C	036D	036E	036F
880	0370	0371	0372	0373	0374	0375	0376	0377	0378	0379
890	037A	037B	037C	037D	037E	037F	0380	0381	0382	0383
900	0384	0385	0386	0387	0388	0389	038A	038B	038C	038D
910	038E	038F	0390	0391	0392	0393	0394	0395	0396	0397
920	0398	0399	039A	039B	039C	039D	039E	039F	03A0	03A1
930	03A2	03A3	03A4	03A5	03A6	03A7	03A8	03A9	03AA	03AB
940	03AC	03AD	03AE	03AF	03B0	03B1	03B2	03B3	03B4	03B5
950	03B6	03B7	03B8	03B9	03BA	03BB	03BC	03BD	03BE	03BF
960	03C0	03C1	03C2	03C3	03C4	03C5	03C6	03C7	03C8	03C9
970	03CA	03CB	03CC	03CD	03CE	03CF	03D0	03D1	03D2	03D3
980	03D4	03D5	03D6	03D7	03D8	03D9	03DA	03DB	03DC	03DD
990	03DE	03DF	03E0	03E1	03E2	03E3	03E4	03E5	03E6	03E7

Decimal/Hexadecimal Table

	0	1	2	3	4	5	6	7	8	9
1000	03E8	03E9	03EA	03EB	03EC	03ED	03EE	03EF	03F0	03F1
1010	03F2	03F3	03F4	03F5	03F6	03F7	03F8	03F9	03FA	03FB
1020	03FC	03FD	03FE	03FF	0400	0401	0402	0403	0404	0405
1030	0406	0407	0408	0409	040A	040B	040C	040D	040E	040F
1040	0410	0411	0412	0413	0414	0415	0416	0417	0418	0419
1050	041A	041B	041C	041D	041E	041F	0420	0421	0422	0423
1060	0424	0425	0426	0427	0428	0429	042A	042B	042C	042D
1070	042E	042F	0430	0431	0432	0433	0434	0435	0436	0437
1080	0438	0439	043A	043B	043C	043D	043E	043F	0440	0441
1090	0442	0443	0444	0445	0446	0447	0448	0449	044A	044B
1100	044C	044D	044E	044F	0450	0451	0452	0453	0454	0455
1110	0456	0457	0458	0459	045A	045B	045C	045D	045E	045E
1120	0460	0461	0462	0463	0464	0465	0466	0467	0468	0469
1130	046A	046B	046C	046D	046E	046F	0470	0471	0472	0473
1140	0474	0475	0476	0477	0478	0479	047A	047B	047C	047D
1150	047E	047F	0480	0481	0482	0483	0484	0485	0486	0487
1160	0488	0489	048A	048B	048C	048D	048E	048F	0490	0491
1170	0492	0493	0494	0495	0496	0497	0498	0499	049A	049B
1180	049C	049D	049E	049F	04A0	04A1	04A2	04A3	04A4	04A5
1190	04A6	04A7	04A8	04A9	04AA	04AB	04AC	04AD	04AE	04AF
1200	04B0	04B1	04B2	04B3	04B4	04B5	04B6	04B7	04B8	04B9
1210	04BA	04BB	04BC	04BD	04BE	04BF	04C0	04C1	04C2	04C3
1220	04C4	04C5	04C6	04C7	04C8	04C9	04CA	04CB	04CC	04CD
1230	04CE	04CF	04D0	04D1	04D2	04D3	04D4	04D5	04D6	04D7
1240	04D8	04D9	04DA	04DB	04DC	04DD	04DE	04DF	04E0	04E1
1250	04E2	04E3	04E4	04E5	04E6	04E7	04E8	04E9	04EA	04EB
1260	04EC	04ED	04EE	04EF	04F0	04F1	04F2	04F3	04F4	04F5
1270	04F6	04F7	04F8	04F9	04FA	04FB	04FC	04FD	04FE	04FF
1280	0500	0501	0502	0503	0504	0505	0506	0507	0508	0509
1290	050A	050B	050C	050D	050E	050F	0510	0511	0512	0513
1300	0514	0515	0516	0517	0518	0519	051A	051B	051C	051D
1310	051E	051F	0520	0521	0522	0523	0524	0556	0526	0527
1320	0528	0529	052A	052B	052C	052D	052E	052E	0530	0531
1330	0532	0533	0534	0535	0536	0537	0538	0539	053A	053B
1340	053C	053D	053E	053F	0540	0541	0542	0543	0544	0545
1350	0546	0547	0548	0549	054A	054B	054C	054D	054E	054F
1360	0550	0551	0552	0553	0554	0555	0556	0557	0558	0559
1370	055A	055B	055C	055D	055E	055F	0560	0561	0562	0563
1380	0564	0565	0566	0567	0568	0569	056A	056B	056C	056D
1390	056E	056F	0570	0571	0572	0573	0574	0575	0576	0577
1400	0578	0579	057A	057B	057C	057D	057E	057F	0580	0581
1410	0582	0583	0584	0585	0586	0587	0588	0589	058A	058B
1420	058C	058D	058E	058F	0590	0591	0592	0593	0594	0595
1430	0596	0597	0598	0599	059A	059B	059C	059D	059E	059F
1440	05A0	05A1	05A2	05A3	05A4	05A5	05A6	05A7	05A8	05A9
1450	05AA	05AB	05AC	05AD	05AE	05AF	05B0	05B1	05B2	05B3
1460	05B4	05B5	05B6	05B7	05B8	05B9	05BA	05BB	05BC	05BD
1470	05BE	05BF	05C0	05C1	05C2	05C3	05C4	05C5	05C6	05C7
1480	05C8	05C9	05CA	05CB	05CC	05CD	05CE	05CF	05D0	05D1
1490	05D2	05D3	05D4	05D5	05D6	05D7	05D8	05D9	05DA	05DB

Troubleshooting

NETWORK	MODULE	Cause/Symptom	Remedy
<input type="checkbox"/> (OFF)	<input type="checkbox"/>	No power at the drive.	Check and apply power to the drive.
<input type="checkbox"/>	<input type="checkbox"/>	Module not installed correctly.	Check connections between Module and drive. On 650V Frames C, D, E & F, check the P3 lead.
<input type="checkbox"/>	<input type="checkbox"/>	Hardware fault.	If HEALTH and RUN LEDs are OFF, replace the drive, else replace the Module.
<input type="checkbox"/>	<input checked="" type="checkbox"/>	The self-test has failed.	Replace the Module.
<input type="checkbox"/>	<input checked="" type="checkbox"/>	Incorrect Module fitted or selected.	Fit the correct Module or select FIELDBUS in the COMMS PORTS function block.
<input type="checkbox"/>	<input checked="" type="checkbox"/>	Set-up fault. A COMMS PORTS parameter is out-of-range.	Select the correct value for the parameter in the COMMS PORTS function block.
<input type="checkbox"/>	<input checked="" type="checkbox"/>	No communications or intermittent failure	Check wiring, verifying the continuity of A and B connections to the master, and ensure that the correct terminals have been used. Pay particular attention to the integrity of the screening.
<input type="checkbox"/>	<input checked="" type="checkbox"/>	No communications or intermittent failure	Ensure that the maximum line length of transmission line has not been exceeded for the Baud rate in use. Refer to "Maximum Line Length Per Segment", page 4.
<input type="checkbox"/>	<input checked="" type="checkbox"/>	No communications or intermittent failure	Ensure that the first and last units on the transmission line are terminated correctly. Note that some equipment has built-in resistors which may be switched in and out of circuit.
<input checked="" type="checkbox"/>	<input checked="" type="checkbox"/>	Waiting for valid Parameterisation data	Check the COMMS ADDRESS parameter. Check that it is unique.
<input checked="" type="checkbox"/>	<input checked="" type="checkbox"/>	Waiting for valid Parameterisation data	Ensure that the network has been correctly configured and that the configuration has been correctly downloaded to the master.
<input checked="" type="checkbox"/>	<input checked="" type="checkbox"/>	Waiting for valid Parameterisation data	Verify that the GSD file being used is correct by loading it into the GSD file configurator to check the format.
<input checked="" type="checkbox"/>	<input checked="" type="checkbox"/>	Waiting for valid Configuration data	
<input checked="" type="checkbox"/>	<input checked="" type="checkbox"/>	Read/Write failure	Use the Tag 921, Profibus Option Error Information, to determine which tag is the source of the read/write error.
<input checked="" type="checkbox"/>	<input checked="" type="checkbox"/>	The unit should now be working.	If there is still a problem, please check your Tag numbers.