

---

# 8903/IM, 8903/IP & 8903/PN Ethernet Communications Option

## Technical Manual

HA500522U002 Issue 2

© Copyright 2010 Parker Hannifin Ltd.

All rights strictly reserved. No part of this document may be stored in a retrieval system, or transmitted in any form or by any means to persons not employed by a Parker Hannifin Ltd., Automation Group, SSD Drives Europe without written permission from Parker Hannifin Ltd., Automation Group, SSD Drives Europe. Although every effort has been taken to ensure the accuracy of this document it may be necessary, without notice, to make amendments or correct omissions. Parker Hannifin Ltd., Automation Group, SSD Drives Europe cannot accept responsibility for damage, injury, or expenses resulting there from.

### WARRANTY

Parker Hannifin Ltd., Automation Group, SSD Drives Europe, warrants the goods against defects in design, materials and workmanship for the period of 24 months from the date of manufacture, or 12 months from the date of delivery (whichever is the longer period) on the terms detailed in Parker SSD Drives Standard Conditions of Sale IA500504.

Parker Hannifin Ltd., Automation Group, SSD Drives Europe reserves the right to change the content and product specification without notice.

**FAILURE OR IMPROPER SELECTION OR IMPROPER USE OF THE PRODUCTS DESCRIBED HEREIN OR RELATED ITEMS CAN CAUSE DEATH, PERSONAL INJURY AND PROPERTY DAMAGE.**

This document and other information from Parker-Hannifin Corporation, its subsidiaries and authorized distributors provide product or system options for further investigation by users having technical expertise.

The user, through its own analysis and testing, is solely responsible for making the final selection of the system and components and assuring that all performance, endurance, maintenance, safety and warning requirements of the application are met. The user must analyze all aspects of the application, follow applicable industry standards, and follow the information concerning the product in the current product catalog and in any other materials provided from Parker or its subsidiaries or authorized distributors.

To the extent that Parker or its subsidiaries or authorized distributors provide component or system options based upon data or specifications provided by the user, the user is responsible for determining that such data and specifications are suitable and sufficient for all applications and reasonably foreseeable uses of the components or systems.

# Safety Information



## Requirements

**IMPORTANT:** Please read this information BEFORE installing the equipment.

### Intended Users

This manual is to be made available to all persons who are required to install, configure or service equipment described herein, or any other associated operation.

The information given is intended to highlight safety issues, EMC considerations, and to enable the user to obtain maximum benefit from the equipment.

Complete the following table for future reference detailing how the unit is to be installed and used.

INSTALLATION DETAILS	
<b>Model Number</b> <i>(see product label)</i>	
<b>Where installed</b> <i>(for your own information)</i>	
<b>Unit used as a:</b> <i>(refer to Certification for the Inverter)</i>	<input type="radio"/> Component <input type="radio"/> Relevant Apparatus
<b>Unit fitted:</b>	<input type="radio"/> Wall-mounted <input type="radio"/> Enclosure



### Application Area

The equipment described is intended for industrial motor speed control utilising DC motors, AC induction or AC synchronous machines

### Personnel

Installation, operation and maintenance of the equipment should be carried out by qualified personnel. A qualified person is someone who is technically competent and familiar with all safety information and established safety practices; with the installation process, operation and maintenance of this equipment; and with all the hazards involved.

### Product Warnings

	<b>Caution</b> Risk of electric shock		<b>Caution</b> Refer to documentation		<b>Earth/Ground</b> Protective Conductor Terminal
---	--	---	--	---	--

# Safety Information



## Hazards

### **DANGER! - Ignoring the following may result in injury**

1. This equipment can endanger life by exposure to rotating machinery and high voltages.
2. The equipment must be permanently earthed due to the high earth leakage current, and the drive motor must be connected to an appropriate safety earth.
3. Ensure all incoming supplies are isolated before working on the equipment. Be aware that there may be more than one supply connection to the drive.
4. There may still be dangerous voltages present at power terminals (motor output, supply input phases, DC bus and the brake, where fitted) when the motor is at standstill or is stopped.
5. For measurements use only a meter to IEC 61010 (CAT III or higher). Always begin using the highest range. CAT I and CAT II meters must not be used on this product.
6. Allow at least 5 minutes for the drive's capacitors to discharge to safe voltage levels (<50V). Use the specified meter capable of measuring up to 1000V dc & ac rms to confirm that less than 50V is present between all power terminals and earth.
7. Unless otherwise stated, this product must NOT be dismantled. In the event of a fault the drive must be returned. Refer to "Routine Maintenance and Repair".

### **WARNING! - Ignoring the following may result in injury or damage to equipment**

#### **SAFETY**

Where there is conflict between EMC and Safety requirements, personnel safety shall always take precedence.

- Never perform high voltage resistance checks on the wiring without first disconnecting the drive from the circuit being tested.
- Whilst ensuring ventilation is sufficient, provide guarding and /or additional safety systems to prevent injury or damage to equipment.
- When replacing a drive in an application and before returning to use, it is essential that all user defined parameters for the product's operation are correctly installed.
- All control and signal terminals are SELV, i.e. protected by double insulation. Ensure all external wiring is rated for the highest system voltage.
- Thermal sensors contained within the motor must have at least basic insulation.
- All exposed metalwork in the Inverter is protected by basic insulation and bonded to a safety earth.
- RCDs are not recommended for use with this product but, where their use is mandatory, only Type B RCDs should be used.

#### **EMC**

- In a domestic environment this product may cause radio interference in which case supplementary mitigation measures may be required.
- This equipment contains electrostatic discharge (ESD) sensitive parts. Observe static control precautions when handling, installing and servicing this product.
- This is a product of the restricted sales distribution class according to IEC 61800-3. It is designated as "professional equipment" as defined in EN61000-3-2. Permission of the supply authority shall be obtained before connection to the low voltage supply.

### **CAUTION!**

#### **APPLICATION RISK**

- The specifications, processes and circuitry described herein are for guidance only and may need to be adapted to the user's specific application. We can not guarantee the suitability of the equipment described in this Manual for individual applications.

#### **RISK ASSESSMENT**

Under fault conditions, power loss or unintended operating conditions, the drive may not operate as intended.

In particular:

- Stored energy might not discharge to safe levels as quickly as suggested, and can still be present even though the drive appears to be switched off
- The motor's direction of rotation might not be controlled
- The motor speed might not be controlled
- The motor might be energised

A drive is a component within a drive system that may influence its operation or effects under a fault condition.

Consideration must be given to:

- Stored energy
- Supply disconnects
- Sequencing logic
- Unintended operation

# Contents

Contents

Page

## **ETHERNET COMMUNICATIONS OPTION**

**1**

<b>Introduction .....</b>	<b>1</b>
Product Features .....	1
• Modbus/TCP (8903/IM) .....	1
• Ethernet/IP (8903/IP) .....	1
• Profinet/IO (8903/PN) .....	1
Product Order Codes .....	2
Compatible Firmware.....	2
Restrictions.....	2
<b>Installation.....</b>	<b>3</b>
Wiring the System .....	6
<b>LED Indications .....</b>	<b>7</b>
Network Status (NS) and Module Status (MS) LEDs .....	7
• Modbus/TCP .....	7
• Ethernet/IP .....	8
• Profinet/IO .....	8
LINK/Activity LED.....	9
<b>Drive Diagnostics.....</b>	<b>10</b>
• The Ethernet MMI View.....	10
• Parameter Descriptions .....	10
<b>Configuring the Ethernet System.....</b>	<b>12</b>
Step 1: Configuring the Ethernet Option using DSE.....	12
• Step 1.1: Inserting an Ethernet Function Block .....	12
• Step 1.2: Attaching Fieldbus Connectors .....	13
• Step 1.3 : Configuring the Fieldbus Connectors.....	14
• DSE Data Types .....	16
• Ethernet Data Types .....	16
• Conversion of DSE Type < > Ethernet Type .....	16
• DSE Input and Output Behaviour (Modbus TCP/IP and Ethernet IP Only)...	16
• DSE Input and Output Behaviour (Profinet IO Only).....	16
Step 2: Configuring the PLC/SCADA Supervisor .....	17
• Modbus/TCP .....	17
• Ethernet/IP .....	24
• Profinet/IO .....	28
<b>Configuring DSE to Connect over Ethernet .....</b>	<b>34</b>
<b>Appendix A: Network States .....</b>	<b>35</b>
<b>Appendix B : DSE/Ethernet Conversion Rules .....</b>	<b>36</b>
• LOGIC Type Connector .....	36
• INTEGER Type Connector.....	36
• VALUE Type Connector .....	37



# ETHERNET COMMUNICATIONS OPTION

## Introduction

---

This manual describes the Parker SSD Drives' Ethernet Communications Interface Options.

### Product Features

- Suitable for use with 890CD Common Bus Drive, 890SD Standalone Drive and 890PX Drive
- Galvanically isolated bus electronics
- LEDs to indicate network and module status
- Software configurable
- Up to 256 bytes of input data and 256 bytes of output data
- Up to 128 DSE input registers and 128 DSE output registers
- Supports RTNX protocol to connect to Drive System Explorer (DSE)
- Web Server and FTP Server

### Modbus/TCP (8903/IM)

- Modbus TCP/IP
- 10/100Mbit/s
- Up to 4 simultaneous connections

### Ethernet/IP (8903/IP)

- Ethernet IP
- 10/100Mbit/s
- Level 2 I/O Server CIP
- Supports 4 class 1 connections (for cyclic I/O data transfer)
- Supports 16 class 3 connections (for explicit messaging)
- EDS file available

### Profinet/IO (8903/PN)

- Real-Time (RT) Profinet IO
- 100Mbit/s
- GSD file available



1	NETWORK and MODULE status LEDs	3	LINK Activity LED
2	RJ45 Ethernet Interface	4	Connector to Control Board

Figure 1. Ethernet Option

### Product Order Codes

	Not fitted order code:	Factory fitted order code:
Ethernet Modbus/TCP Option	8903-IM-00	not available
Ethernet/IP Option	8903-IP-00	not available
Ethernet Profinet/IO Option	8903-PN-00	not available

### Compatible Firmware

This option will work with the following versions of 890 firmware:

8903/IM and 8903/IP:	Version 1.11 onwards	Version 3.2 onwards	Version 4.1 onwards
8903/PN:	Version 3.3 onwards	Version 4.1 onwards	

### Restrictions

Option must be fitted in Slot A.



# Installation

## WARNING!

Before installing, ensure that the drive wiring is electrically isolated and cannot be made "live" unintentionally by other personnel. Wait 5 minutes after disconnecting power before working on any part of the system or removing the covers from the drives.

### To Remove the Control Board

1. Remove the blanking plates, each secured by a single screw, that fits over the option slots (1).
2. Loosen the top and bottom screws from the handles of the Control Board (2).
3. Pull gently on the handles and slide the Control Board (2) out of the drive.

*Note:* Save the blanking plate and screw for future use. The drive should not be operated without either an Option or blanking plate fitted. When fitted, these maintain the drive's IP20 rating.

### Caution

This Option contains ESD (Electrostatic Discharge) sensitive parts. Observe static control precautions when handling, installing and servicing this Option.



Figure 2. 890 showing Control Board withdrawn, with Options fitted

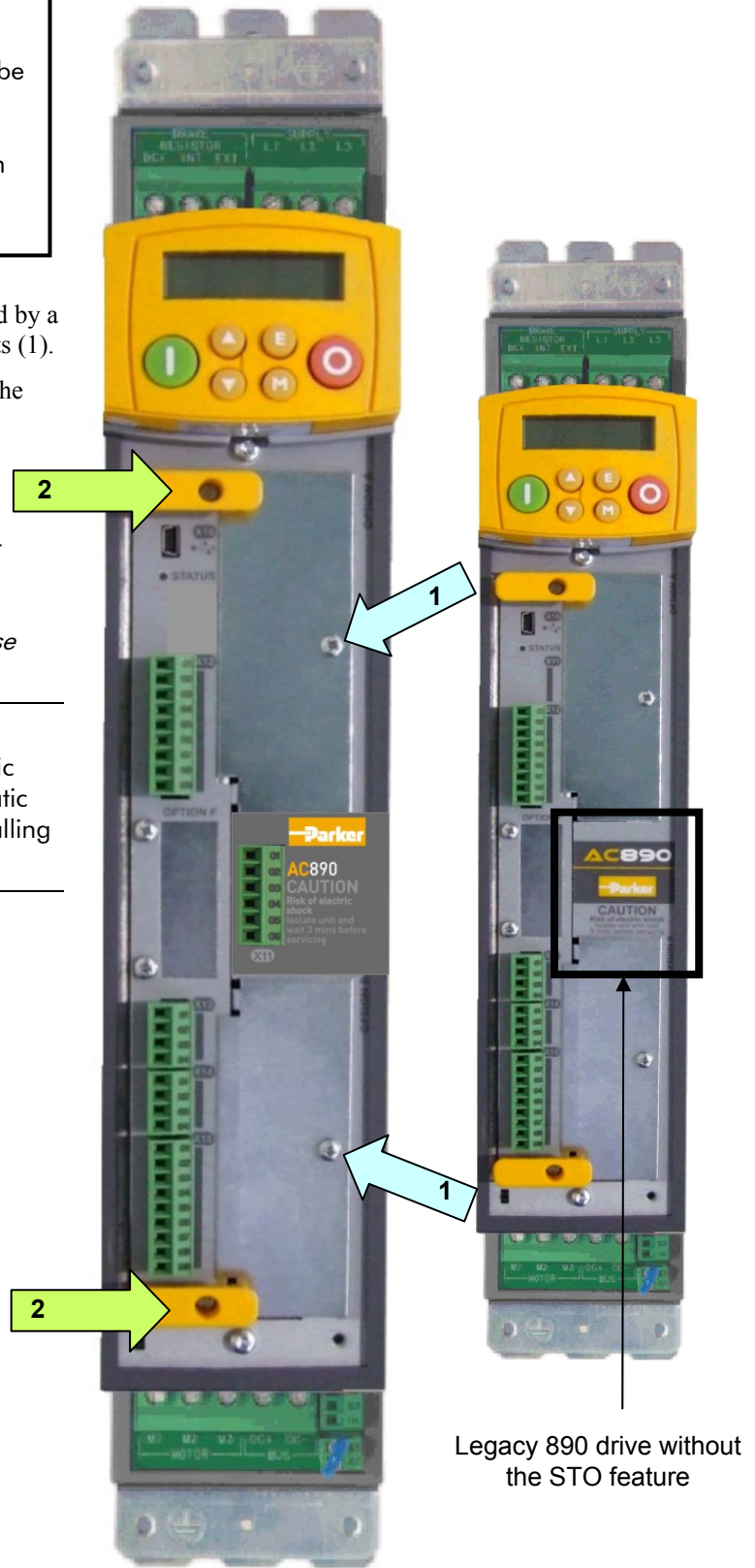

Legacy 890 drive without the STO feature

Figure 3. Front of 890 drive showing Control Board fitted

### Fitting the Option

The Option fits onto the Control Board.

1. Insert the connector into the Option as shown. The legs of the connector will protrude through into the connector on the other side of the Option.
2. Press the assembly into the **TOP** connector (adjacent to terminals X10, X11 and X12) on the Control Board. Ensure that the front panel of the Option overlaps the front of the Control Board.

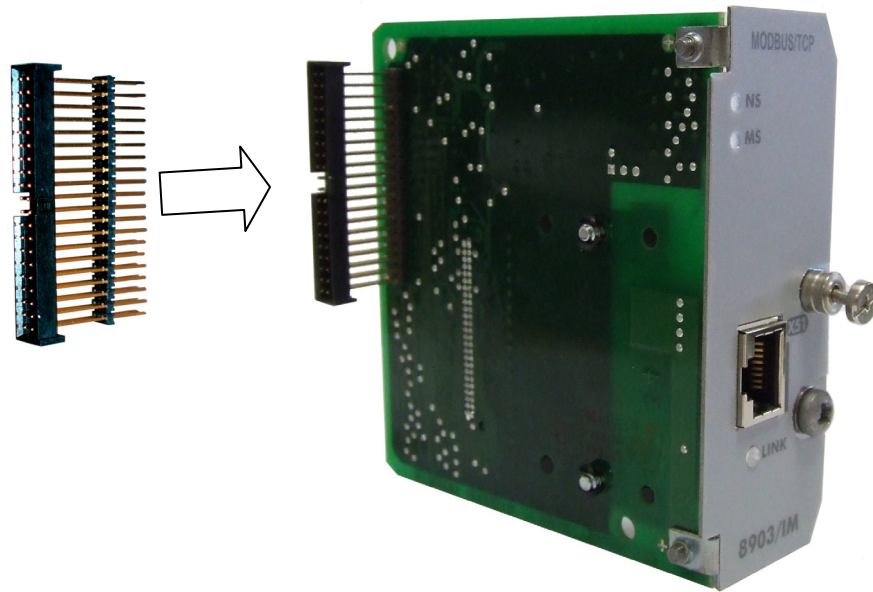

Figure 4. Fitting the connector to the Option

### Re-fitting the Control Board

1. Slide the board into the drive, engaging the edges of the boards into the slots. Push until the back edge of the Control Board PCB locates with the connectors in the drive.
2. Tighten in position using the top and bottom screws in the handles of the Control Board.
3. Screw the Option in position using the captive screw on the front of the Option.

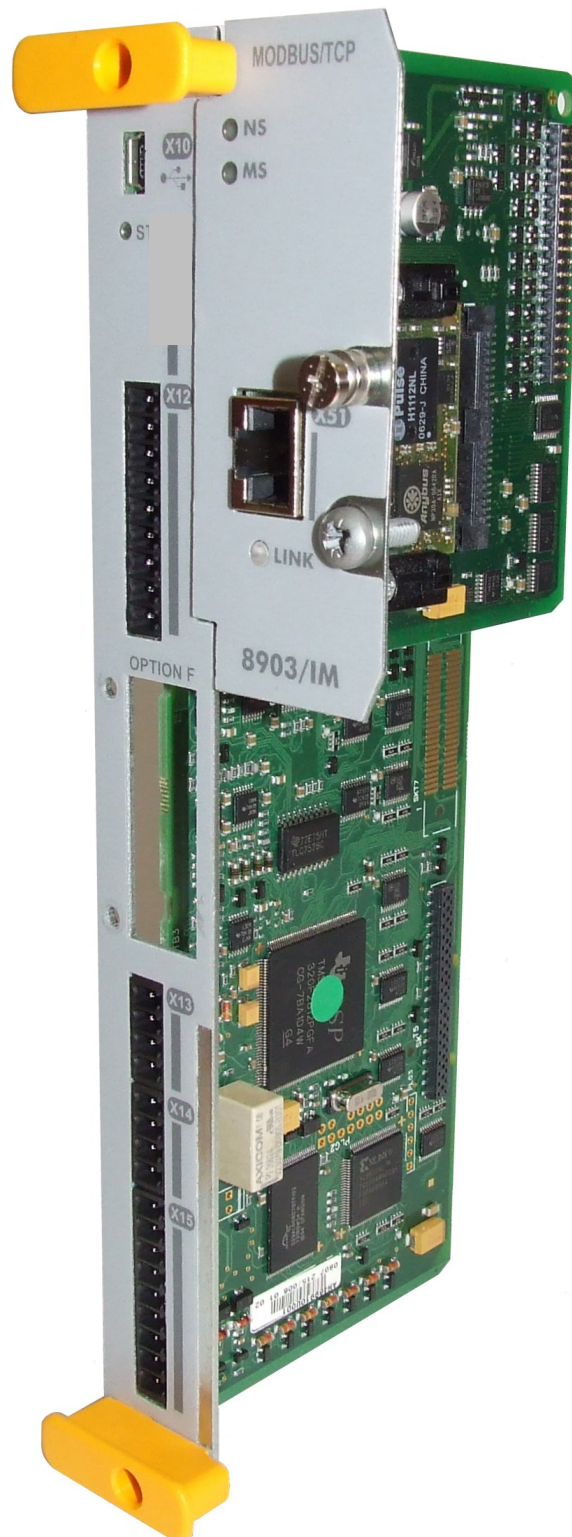

Figure 5. 890 Control Board with Option fitted

## Wiring the System

Connection to the drive(s) from a PC, or PLC for example, is made using a cable fitted with standard RJ45 connectors at both ends. The cable plugs into the PLC, for example, and into the socket on the Ethernet techbox.

**Note:** When connecting to one drive direct from PC/PLC, you must use a crossover cable.

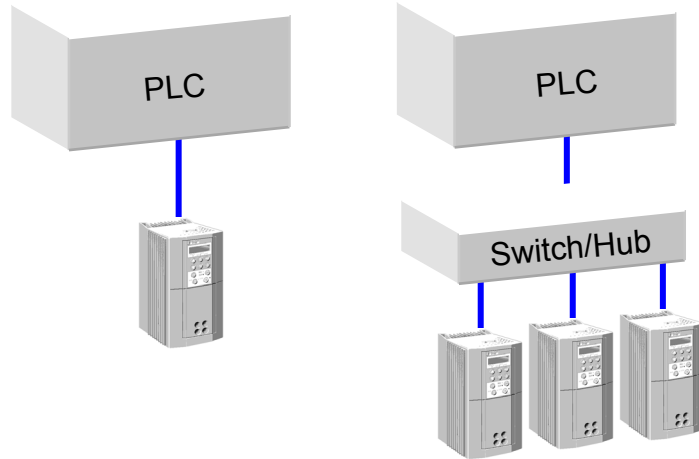
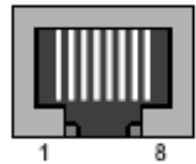

Figure 6. Typical connections to a PLC

### RJ45 (Standard) Pin Details

Pin	Signal
1	TD+
2	TD-
3	RD+
4	Termination
5	Termination
6	RD-
7	Termination
8	Termination



### Cable Specifications

Cable Type	Maximum Node-to-Node Distance (m)
CAT5	100
CAT5E	100

## LED Indications

### Network Status (NS) and Module Status (MS) LEDs

*Note:* A test sequence is performed on these LEDs during start-up.

#### Modbus/TCP

##### Network Status LED (NS)





Colour	LED Indication	Description
 OFF	OFF	No power or no IP Address set
 GREEN	ON	Normal operation
 GREEN	FLASHING	Waiting for connections
 RED	ON	Duplicate IP Address

Figure 7. Modbus/TCP NS LED

##### Module Status LED (MS)





Colour	LED Indication	Description
 OFF	OFF	No power
 GREEN	ON	Normal operation
 GREEN	FLASHING	Major fault
 RED	ON	Duplicate IP Address
 RED	FLASHING	Minor fault

Figure 8. Modbus/TCP MS LED

## Ethernet/IP

### Network Status LED (NS)





Colour	LED Indication	Description
 OFF	OFF	No power or no IP Address set
 GREEN	ON	On-line, one or more connections established
 GREEN	FLASHING	On-line, no connections established
 RED	ON	Duplicate IP address
 RED	FLASHING	One or more connections timed out

Figure 9. Ethernet/IP NS LED

### Module Status LED (MS)





Colour	LED Indication	Description
 OFF	OFF	No power
 GREEN	ON	Controlled by a Scanner in Run state
 GREEN	FLASHING	Not configured, or Scanner in idle state
 RED	ON	Major fault
 RED	FLASHING	Recoverable fault(s)

Figure 10. Ethernet/IP MS LED

## Profinet/IO

### Network Status LED (NS)



Colour	LED Indication	Description
 OFF	OFF	No power No connection with IO controller
 GREEN	ON	Connection with IO controller IO Controller in RUN state
 GREEN	FLASHING	Connection with IO controller IO controller in STOP state

Figure 11. Profinet/IO NS LED

**Module Status LED (MS)**









Colour	LED Indication	Description
 OFF	OFF	No Power Not initialised
 GREEN	ON	Normal operation
 GREEN	1 FLASH	Diagnostic Event
 GREEN	2 FLASHES	Used by engineering tools to identify the node on the network
 RED	ON	Exception error
 RED	1 FLASH	Configuration error
 RED	2 FLASHES	IP address not set
 RED	3 FLASHES	Station name not set
 RED	4 FLASHES	Internal error

Figure 12. Profinet/IO MS LED

**LINK/Activity LED**



Colour	LED Indication	Description
 OFF	OFF	No link, no activity
 GREEN	ON	Link established
 GREEN	Flickering	Activity

Figure 13. LINK/Activity LED



## Drive Diagnostics

### The Ethernet MMI View

Diagnostic information is available through the MMI.

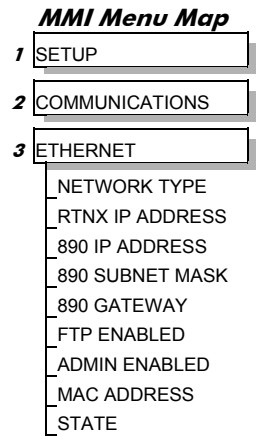

### Parameter Descriptions

<b>NETWORK TYPE</b>	<i>Read Only</i>	<i>Range: Enumerated - see below</i>
Network type of the Ethernet option.		
<i>Enumerated Value: NETWORK TYPE</i>		
0: NONE		
1: UNKNOWN		
2: ETHERNET IP		
3: MODBUS TCP		
4: PROFINET IO		
<b>RTNX IP ADDRESS</b>	<i>Read Only</i>	<i>Range: NOT CONNECTED, XXX.XXX.XXX.XXX</i>
The IP Address of the computer running Drive System Explorer (DSE) is displayed if connected to the 890 via Ethernet.		
If DSE is not connected, then <i>NOT CONNECTED</i> is displayed. Note – this is also displayed if there has been no communications activity from the connected DSE in the last 5 minutes.		
<b>890 IP ADDRESS</b>	<i>Read Only</i>	<i>Range: XXX.XXX.XXX.XXX</i>
IP Address of the 890.		
<b>890 SUBNET MASK</b>	<i>Read Only</i>	<i>Range: XXX.XXX.XXX.XXX</i>
Subnet Mask being used.		
<b>890 GATEWAY</b>	<i>Read Only</i>	<i>Range: XXX.XXX.XXX.XXX</i>
Gateway Address being used.		
<b>FTP ENABLED</b>	<i>Read Only</i>	<i>Range: FALSE / TRUE</i>
Enables the FTP server. This allows access to the file system on the Ethernet option.		
<b>ADMIN ENABLED</b>	<i>Read Only</i>	<i>Range: FALSE / TRUE</i>
Enables the Admin mode. This allows unrestricted access to the file system (without the need for a username and password) on the Ethernet option.		
<b>MAC ADDRESS</b>	<i>Read Only</i>	<i>Range: XX XX XX XX XX XX</i>
Unique MAC address of the Ethernet option.		



**STATE***Read Only**Range: Enumerated - see below*

Operating state of the Ethernet option. The meaning of these depends on the Network Type. See APPENDIX A for details.

*Enumerated Value : STATE*

- 0: UNKNOWN
- 1: SETUP
- 2: INITIALISATION
- 3: WAIT PROCESS
- 4: IDLE
- 5: PROCESS ACTIVE
- 6: ERROR
- 7: EXCEPTION
- 8: WAIT TO CONNECT
- 9: STOPPED
- 10: RUNNING
- 11: FAULT
- 12: NOT ACTIVE
- 13: ACTIVE
- 14: NOT SUPPORTED

## Configuring the Ethernet System

To configure the Ethernet system, complete the steps below.

### Step 1: Configuring the Ethernet Option using DSE

#### Step 1.1: Inserting an Ethernet Function Block

Display your configuration page. Click on the Block menu at the top of the screen.

1. Move the cursor down to select "890 Comms" and select "Ethernet".
2. Click to attach the block icon to the cursor. Move the icon to where you want on the screen. Click again to release the icon.

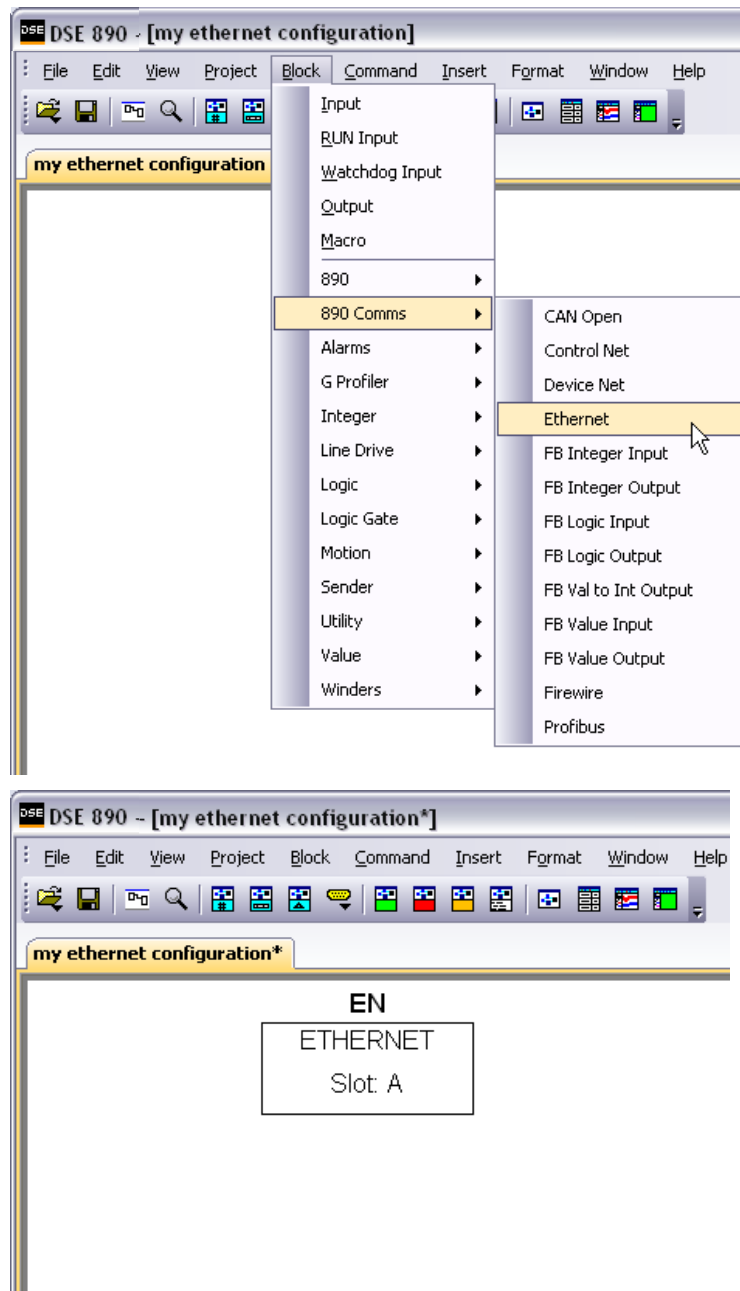

Figure 14. Configuration showing EN Function Block

## Step 1.2: Attaching Fieldbus Connectors

Seven fieldbus connector types are available:

FB Logic Input    FB Integer Input    FB Value Input  
 FB Logic Output    FB Integer Output    FB Value Output    FB Val to Int Output

**Input connector** : the data is sent from PLC to 890

**Output connector** : the data is sent from 890 to PLC

The fieldbus connectors must be added before they will appear in the EtherNet function block.

*Note:* The function block and connectors can be renamed by using the right mouse button and selecting **Rename Block**.

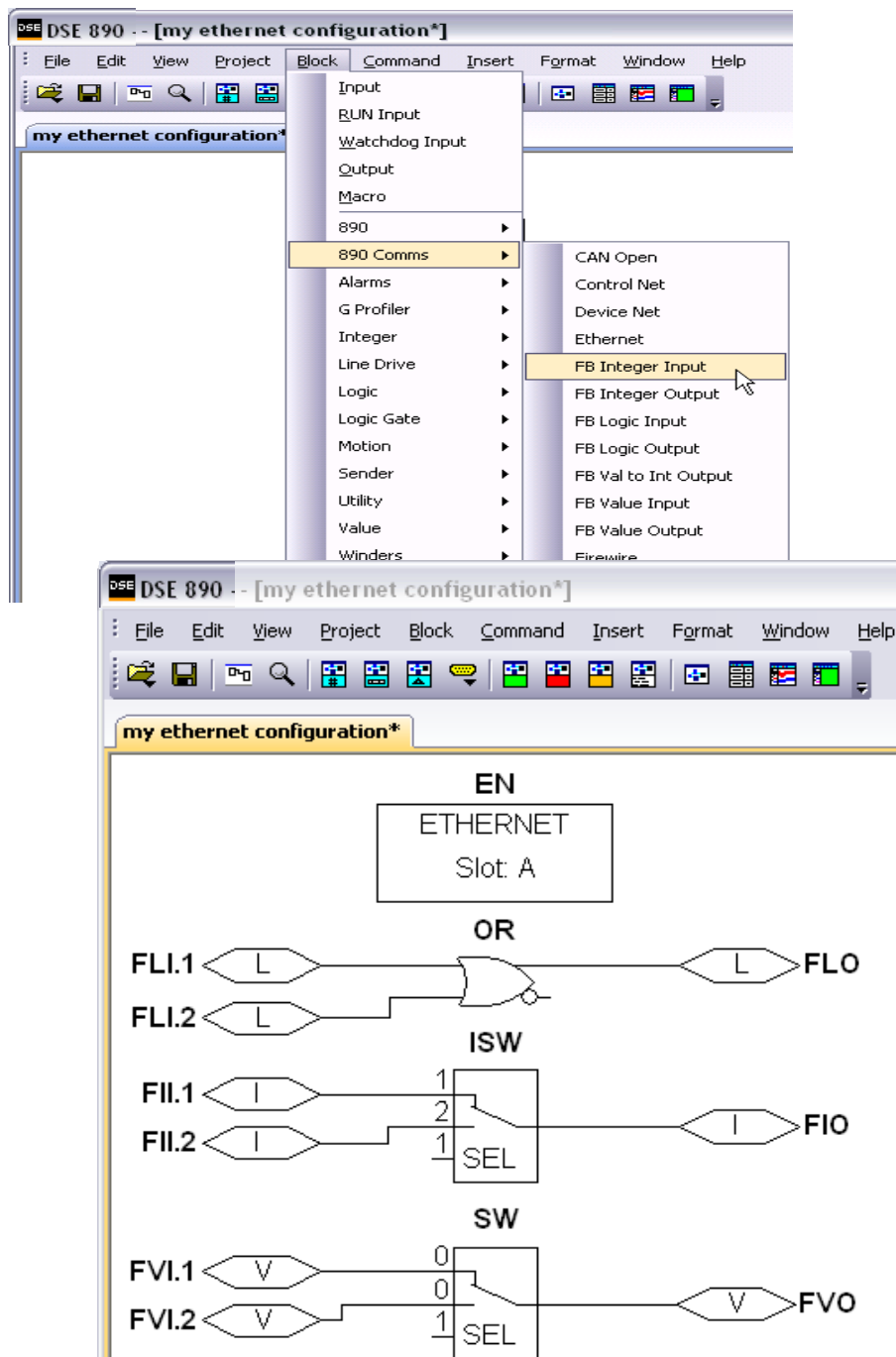
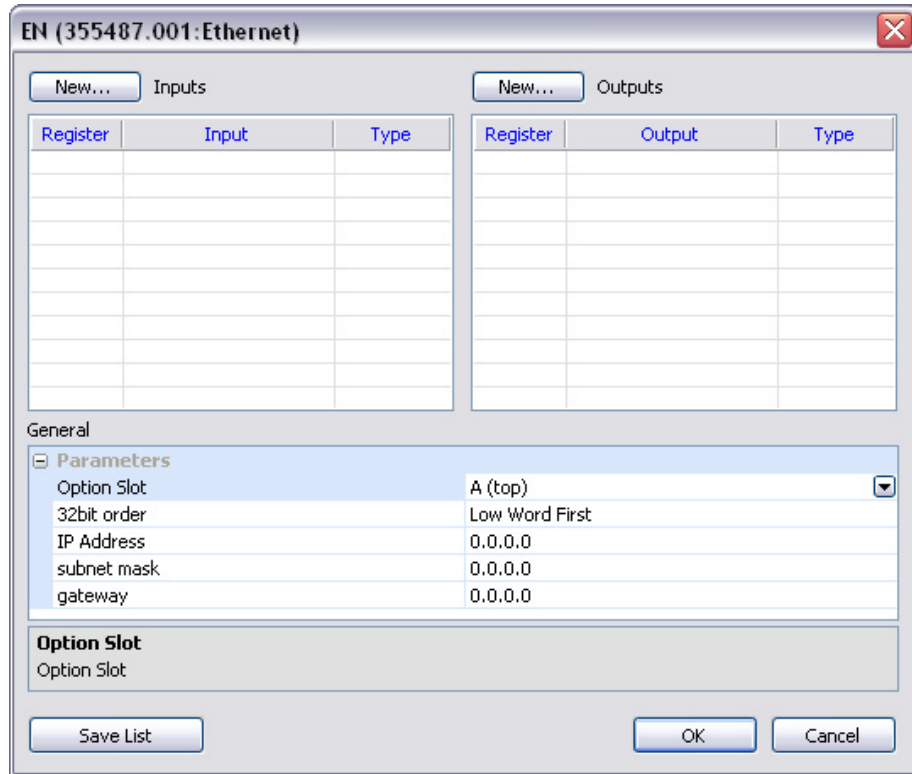

Figure 15. Configuration showing EN Function Block and Fieldbus Connectors

### Step 1.3 : Configuring the Fieldbus Connectors

Double-click on the function block to display the dialog below. The fieldbus connectors (inputs and outputs) are assignable in the function block along with their data type to/from the PLC. The Option Slot, 32-bit Order, IP Address, Subnet Mask and Gateway Address can also be selected.



To configure the input and output connectors you have placed in the configuration:

1. Click on **New...** to add Inputs or Outputs to table.
2. Select the drop-down menu below **Input** to choose the required input connector to be mapped to the Register. For example below, Register 1 "Input" is shown with the possible fieldbus selections that have been placed in the configuration: FII.1 (Fieldbus Integer Input 1), FLI.1 (Fieldbus Logic Input 1), FVI.1 (Fieldbus Value Input 1) etc.

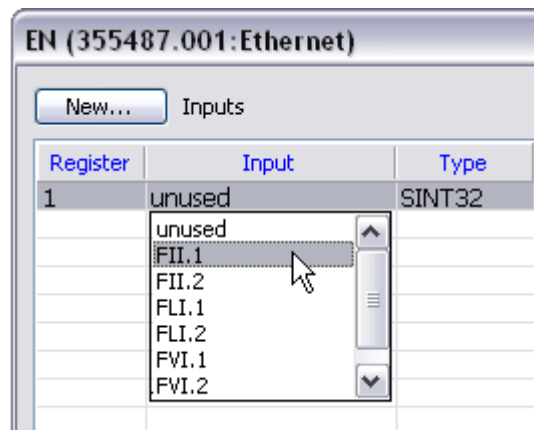
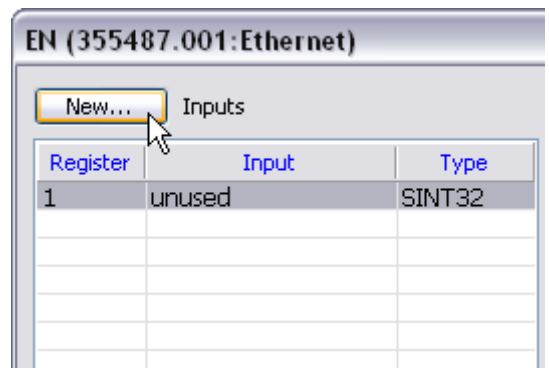

3. Select the drop down menu in the **Type** column to choose the required PLC type on Register 1, for example.

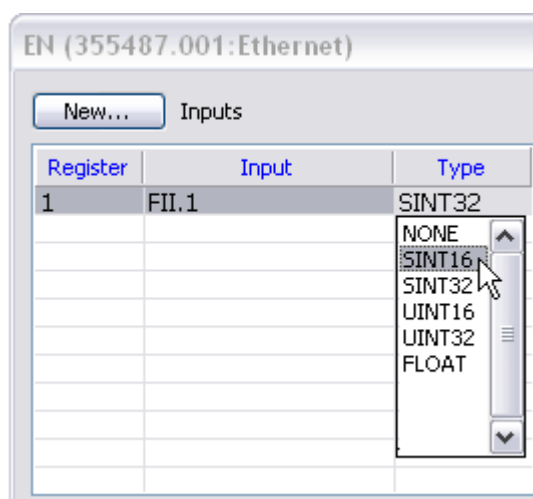

4. Set up all the input/output registers in a similar way.

**Remember:**

- ◆ The order and size of the *inputs* in the DSE Ethernet configuration MUST match the order and size of the *outputs* from the PLC configuration.
- ◆ The order and size of the *outputs* in the DSE ControlNet configuration MUST match the order and size of the *inputs* to the PLC configuration.

5. Set up the option parameters:

General	
Parameters	
Option Slot	A (top)
32bit order	Low Word First
IP Address	192.168.1.6
subnet mask	255.255.255.0
gateway	192.168.1.1

"Option Slot" = A (top). The Ethernet Option can only be fitted in the OPTION A slot of the drive. This is the default setting for "Option Slot".

"32bit order" is set to either "Low Word First" or "High Word First". This refers to how 32-bit data types, i.e. SINT32, UINT32 and FLOAT are encoded on Ethernet. If Ethernet/IP is being used, this should always be Low Word First. If Modbus/TCP is being used, it depends on the master. This parameter has no effect if Profinet/IO is being used.

- **Low Word First** is sometimes referred to as "Modicon Mode" and is used when the least significant 16-bits are sent in a lower register number than the most significant 16-bits, i.e. Little-endian.
- **High Word First** is sometimes referred to as "IEEE Mode" and is used when the most significant 16-bits are sent in a lower register number than the least significant 16-bits, i.e. Big-endian. This mode must be selected when connecting to the TS8000 HMI.

"IP Address", "subnet mask" and "gateway" are used to set the IP parameters. If set to 0.0.0.0 they may be configured over Ethernet, e.g. by using the Address Resolution Protocol (ARP).

## DSE Data Types

Data Type	Description	Range
LOGIC	Logic	False (F) and True (T)
INTEGER	32-bit signed integer	-2,147,483,648 to 2,147,483,647
VALUE	32-bit fixed point value	-32768.0 to 32767.9999

## Ethernet Data Types

Data Type	Description	Range	Bytes Used
SINT16	16-bit signed integer	-32,768 to 32,767	2
SINT32	32-bit signed integer	-2,147,438,648 to 2,147,483,647	4
UINT16	16-bit unsigned integer	0 to 65,535	2
USINT32	32-bit unsigned integer	0 to 4,294,967,295	4
FLOAT	32-bit IEEE-754 floating-point value	1.19209290e-38 to 3.4028235e+38	4

## Conversion of DSE Type < > Ethernet Type

The DSE fieldbus connectors are each assigned an Ethernet "Type" as described in "Step 1.3 : Configuring the Fieldbus Connectors" on page 14.

The conversion between the DSE type and the PLC type is performed automatically (refer to Appendix B : DSE/Ethernet Conversion Rules, page 36).

Any PLC type can be assigned to a fieldbus connector.

## DSE Input and Output Behaviour (Modbus TCP/IP and Ethernet IP Only)

To prevent persistent data within the 890 User Application from being overwritten before it can be used, both the **Inputs** and **Outputs** have a special *Initial Value*. This allows a change-in-value event to be detected.

The *Initial Values* are 8000h for 16-bit data types and 80000000h for 32-bit data types.

Outputs will have this value until a block diagram event causes them to update.

Inputs will only be updated in the block diagram when the incoming value (from PLC) is different from the *Initial Value*.

## DSE Input and Output Behaviour (Profinet IO Only)

### Inputs

No events on the DSE inputs occur until the Profinet IO module transitions into the RUNNING state, when all DSE inputs are updated.

All DSE inputs will be set to zero if the Profinet IO module leaves the RUNNING state due to the PLC being put into STOP mode or due to a loss of connection.

### Outputs

DSE outputs have an initial value of zero until an event in the block diagram causes them to change.

## Step 2: Configuring the PLC/SCADA Supervisor

### Modbus/TCP

The following Modbus TCP/IP functions are supported:

Function Code	Function
3	Read Holding Registers
6	Write Single Register
16	Write Multiple Registers
23	Read/Write Multiple Registers
43 (subcode 14)	Read Device Identification

Holding Registers (4x) are mapped as follows:

Range (decimal)	Contents
00001...00256	Registers To 890
00257...00512	Registers From 890
00516	Connection Timeout in milliseconds. Default 0 (disabled). <i>Note: a value written to this register is persistent, i.e., will not be cleared when power to the Drive is removed.</i>  See Append A "Network States".
00517	Enter/Exit IDLE state. 0: NOT IDLE, >0: IDLE

**Modicon Momentum**

1. Start a new program and select the PLC processor and chassis type used in your project. Our example uses an M1 980-20 Momentum PLC. Stay offline until you are ready to download the program.
2. Place an MSTR block in the ladder logic. MSTR blocks move data from the PLC data table to the drive or from the drive to the PLC data table. Two MSTR blocks are necessary for a Read and Write operation.
3. Right click over the MSTR block. This will access the Register Editor. Use the Register Editor to configure the block. The MSTR block has two types of operations: Read or Write. The first register defines the type of operation. In our case address 40100 is used for write command and address 40200 is used for read command. A value of 1 in the data column defines a Write operation. A value of 2 in the data column defines a Read operation.

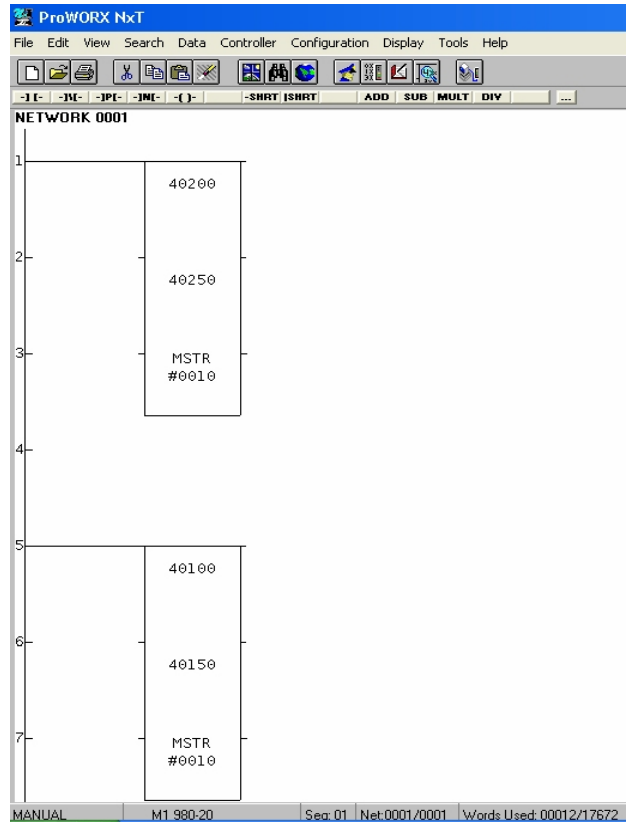

**Figure 16. PLC Ladder Logic showing MSTR Blocks**

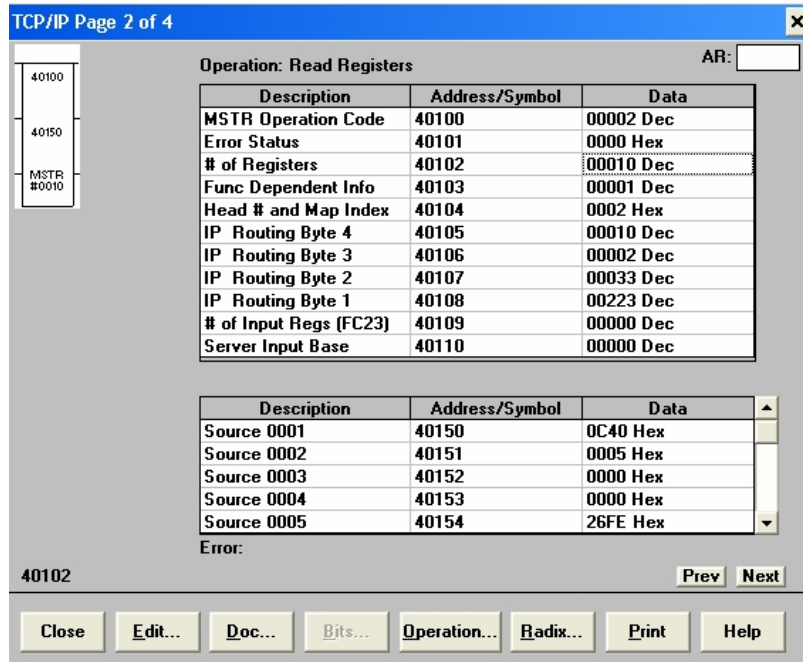

**Figure 17. Read Registers**



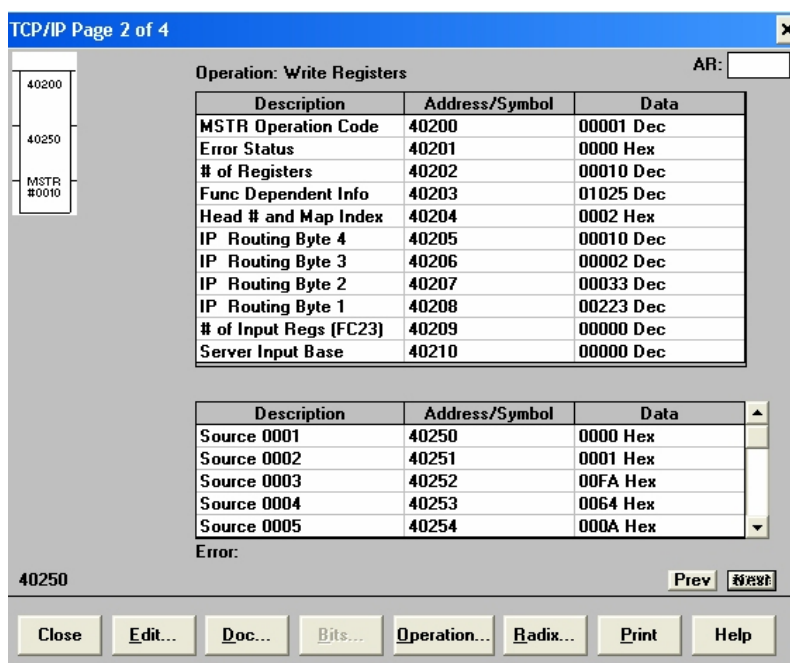
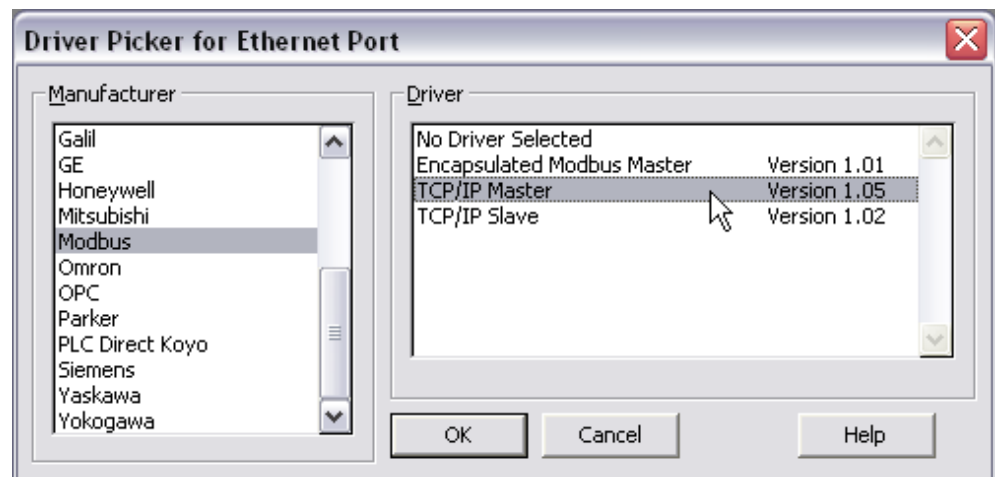
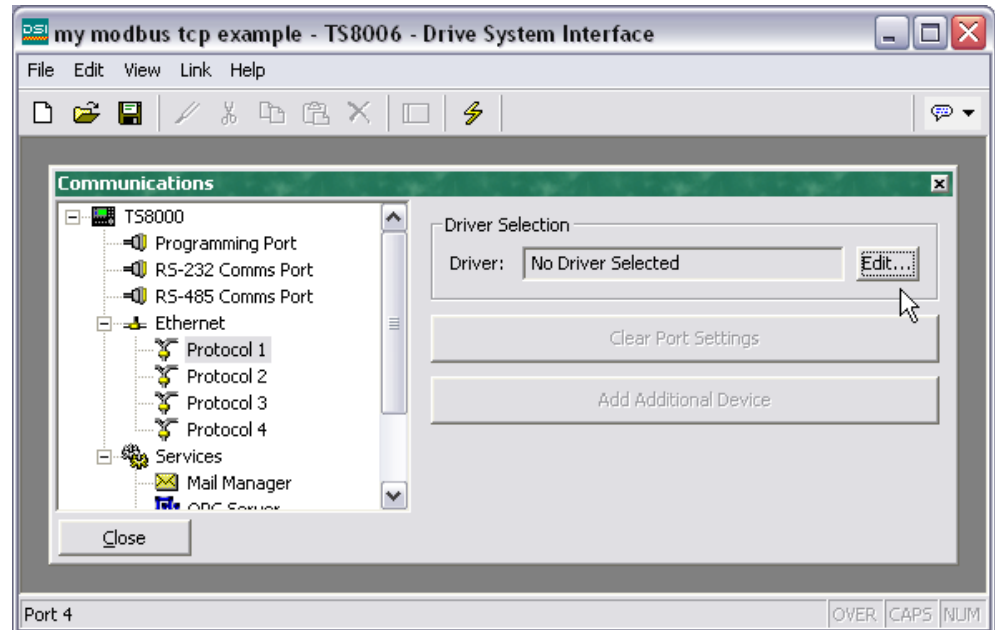

Figure 18 Write Registers

4. The second register contains the error status. Refer to the PLC software help files for a list of error codes.
5. The third register defines the data length (address 40102 or address 40202). The value in the data column depends on which parameter set that has been selected in the drive. The value can be smaller than or equal to the selected parameter set.
6. The fourth register defines the Read and Write locations of the data in the PLC (address 40103 or address 40203). **For a Read function, this value is set to 1, and for a Write function this value is set to 257.**
7. Registers 5, 6, 7 and 8 define the IP address on the Ethernet network (address 40104 or address 40204). Our example shows the data registers starting at locations 40150 and 40250.
8. When using a Modicon PLC, the “32bit Word Order” parameter in the Ethernet function block must be set to “Low Word First”. This applies to Modicon products and most other manufactures using the ModBus/TCP protocol.

## TS8000 Operator Station using DSI8000

1. Select Modbus TCP/IP protocol for Ethernet Port. The TS8000 is the Master.



- Set the Slave IP address to match the one configured in the 890.

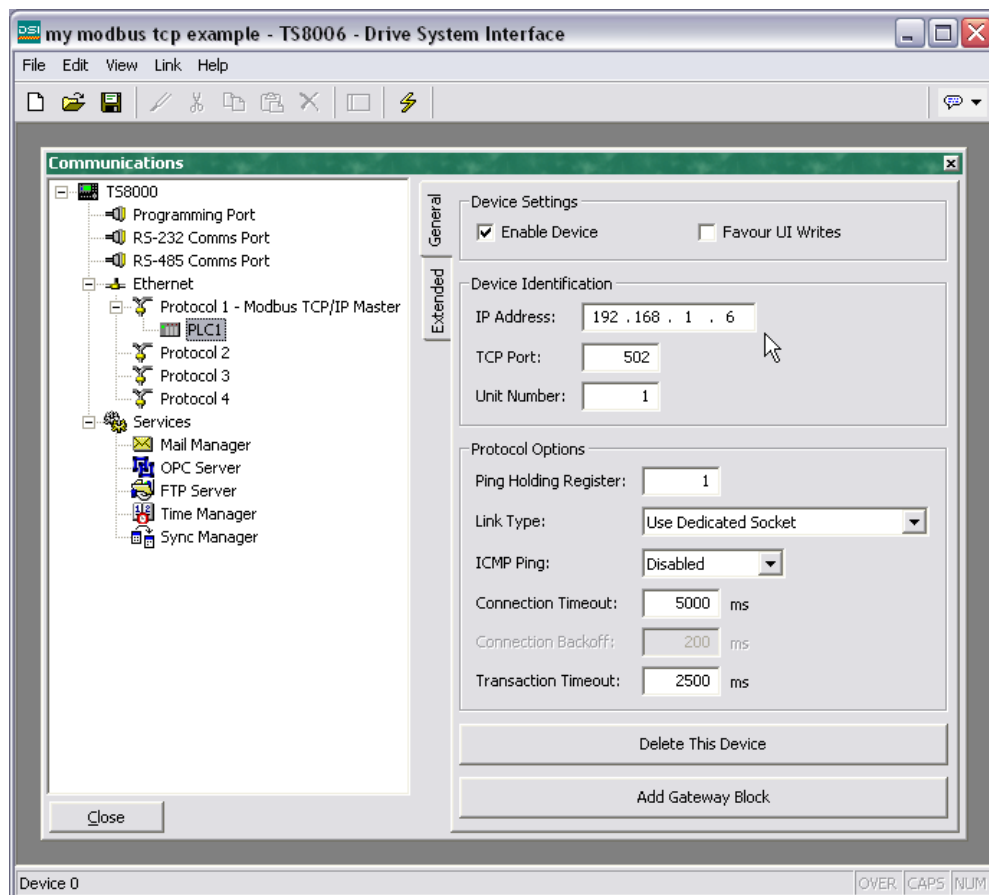

- The name of the Slave can be changed and additional Slaves added.

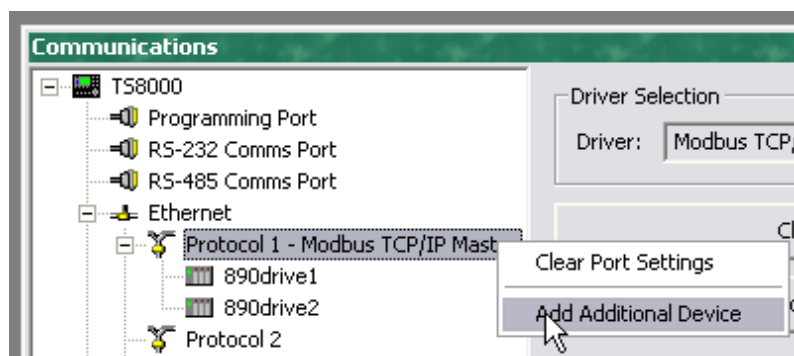

4. Create Tags for reading and writing variables.

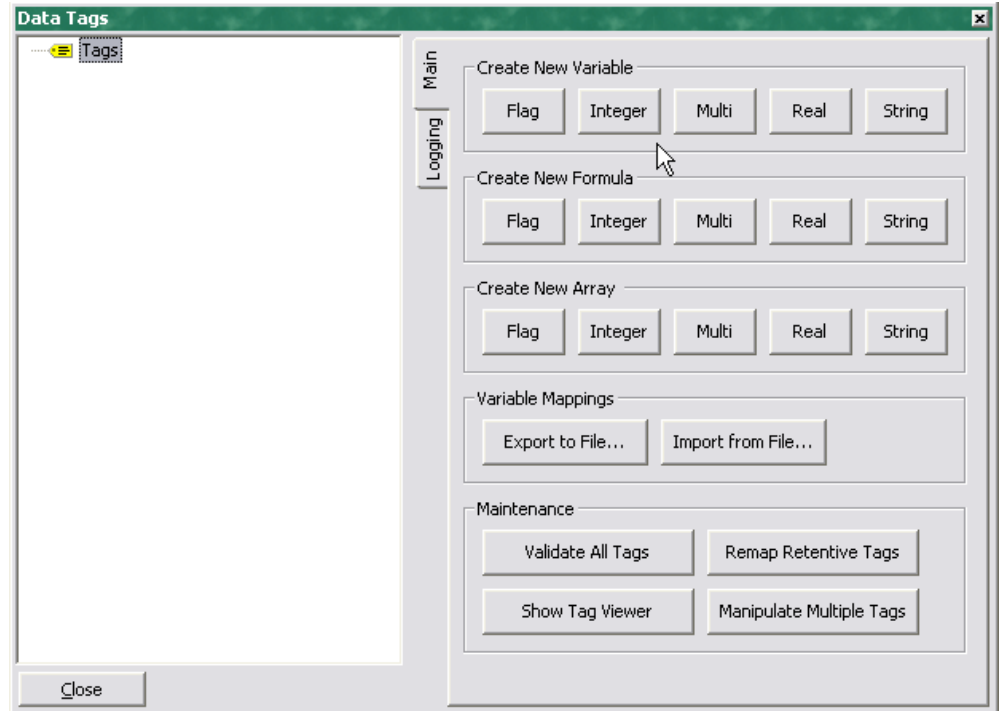

Create either an Integer or a Real variable and map it to the correct Slave.

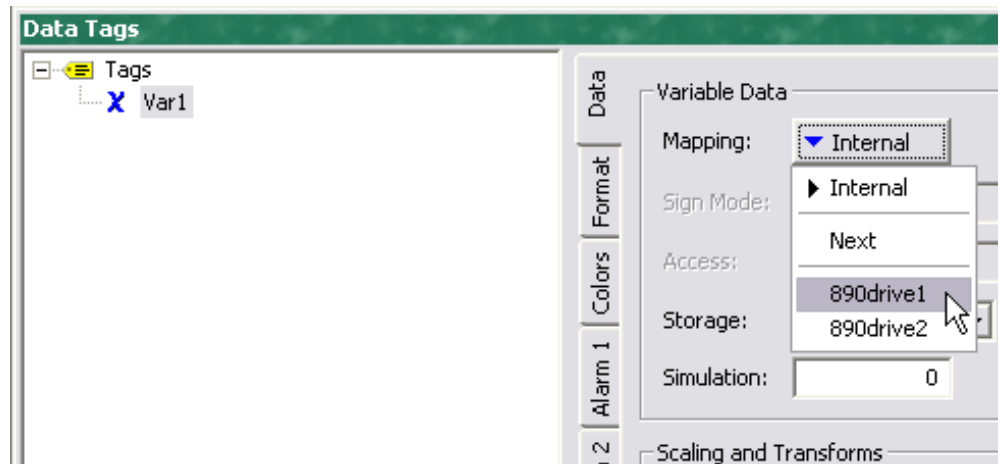

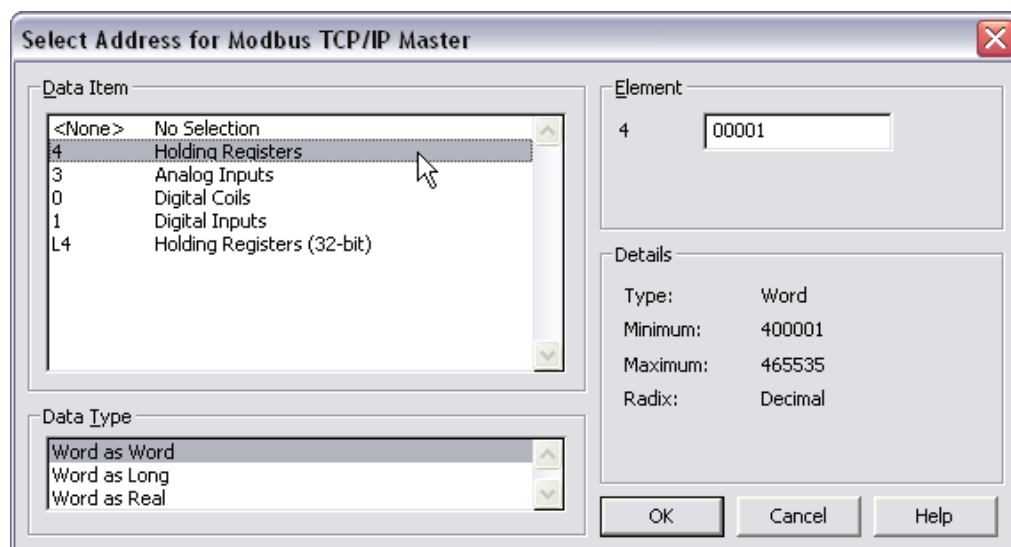
**Data Item:**

Always select **Holding Registers** for both 16-bit and 32-bit data types. **DO NOT SELECT “Holding Registers (32-bit)”**.

**Element:**

Set to **00001** to write to the first Input variable declared in DSE.

Set to **00257** to read the first Output variable declared in DSE.

The element number then increments by 1 if the Data Type of the previous variable is **Word as Word**, otherwise it increments by 2.

**Data Type:**

Set as follows:

DSE Type	TS8000 Data Type
SINT16	Word as Word
UINT16	
SINT32	Word as Long
UINT32	
REAL	Word as Real

## Ethernet/IP

### Allen Bradley ControlLogix

1. Start a new program and select the PLC processor and chassis type that is used in your project. Our example uses a 1756-L55A processor and 1756-A7/B rack. Remain Offline until you are ready to download the program.
2. Using the I/O Configuration insert the Ethernet interface that will be installed. Right click on the I/O Configuration, select New Module. Our example uses 1756-ENBT/A. Input the desired IP address and slot in the PLC..

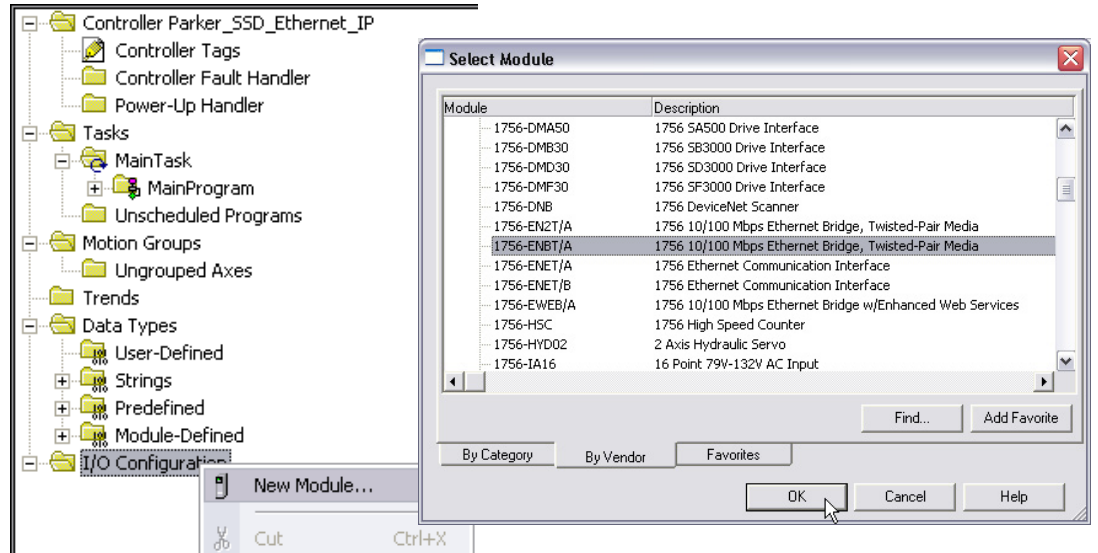

Figure 19. Ethernet Interface Selection

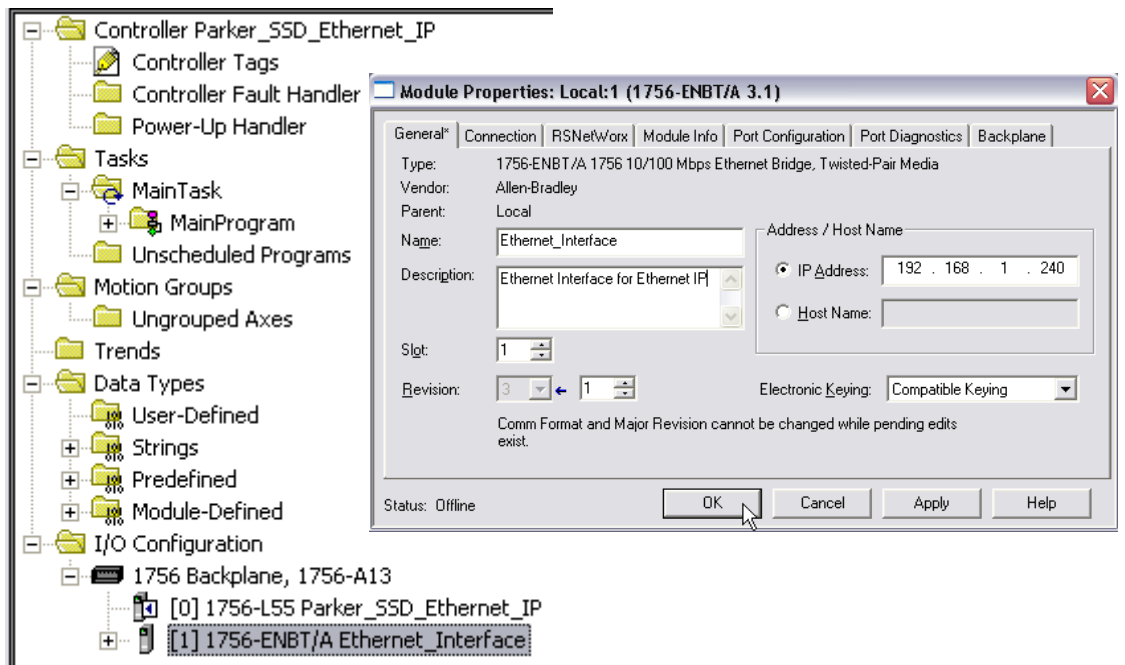

Figure 20. Ethernet Interface Setup

- Right click on the Ethernet Interface Module, select New Module. This screen will allow the selection of the Generic Ethernet Module. Refer to Figure 21.

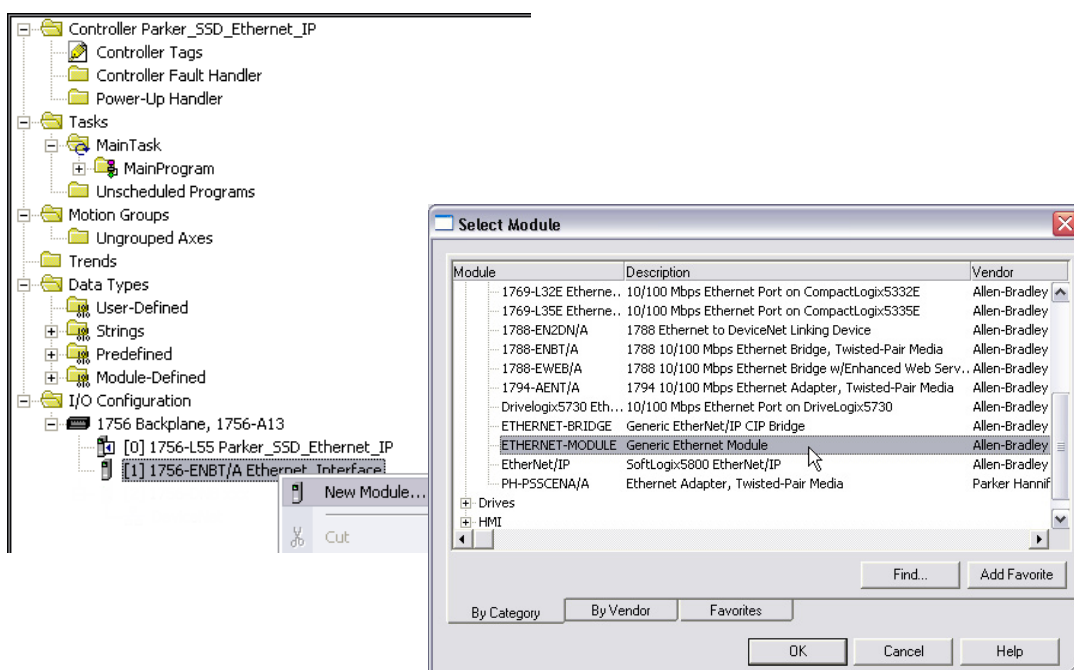

Figure 21. Generic Ethernet Module Select

- Input the desired module name and IP address. The Comms format will be DATA Int if 16-bit signed integer, or Data-REAL if 32-bit floating point. The Input Assembly Instance is 100 and the Output Assembly Instance is 150. Refer to Figure 22.
- Click on Next to change the Requested Packet Interval (RPI). The default value of 10ms should be sufficient. If the RPI is set below 5ms unreliable communications may be experienced. Refer to Figure 22.

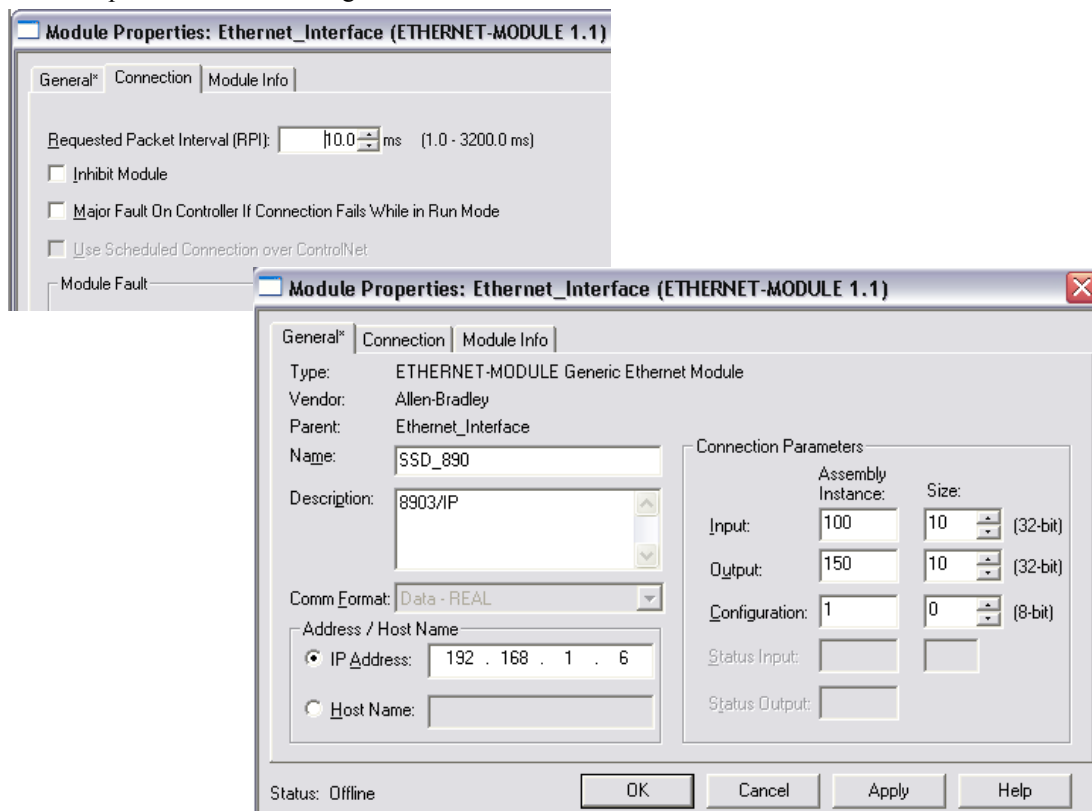

Figure 22 Generic Ethernet Module Setup

- When completed with the setup of the Generic Ethernet Module it can be downloaded to the PLC. For testing purposes it is not necessary to program Ladder Logic in the PLC. The data can be accessed and monitored via Controller Tags. Refer to Figure 23.

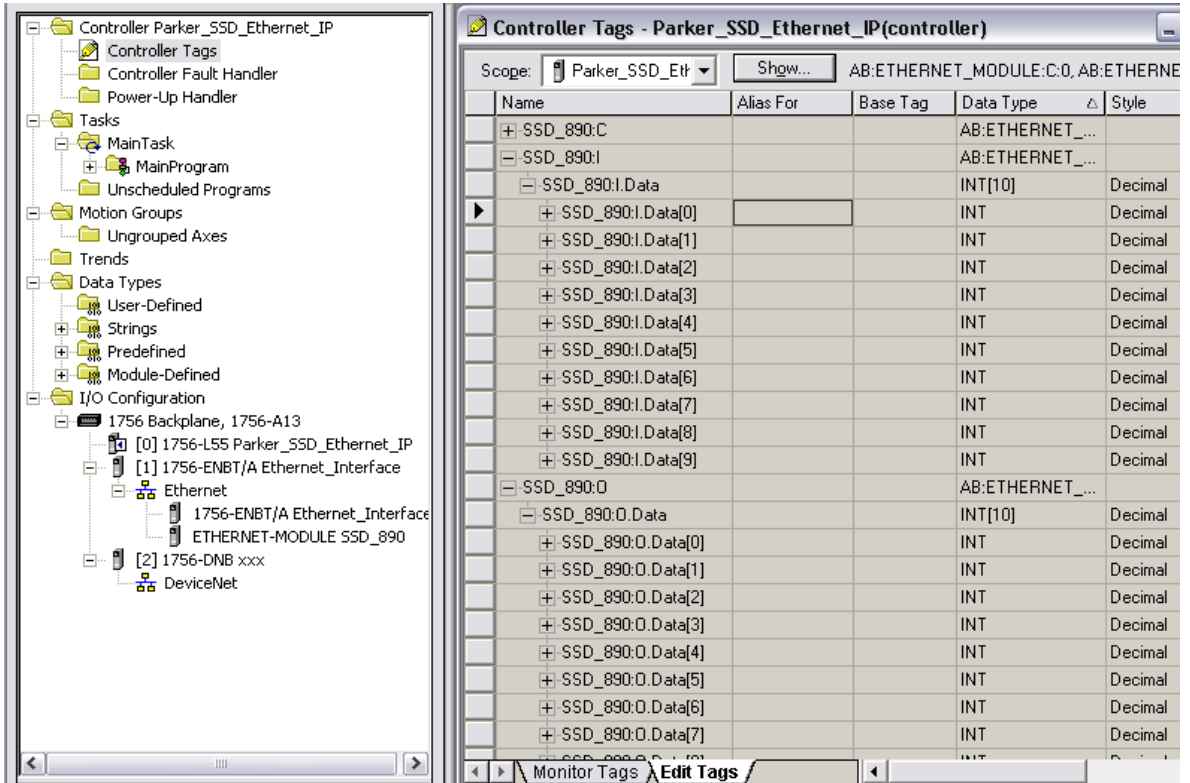
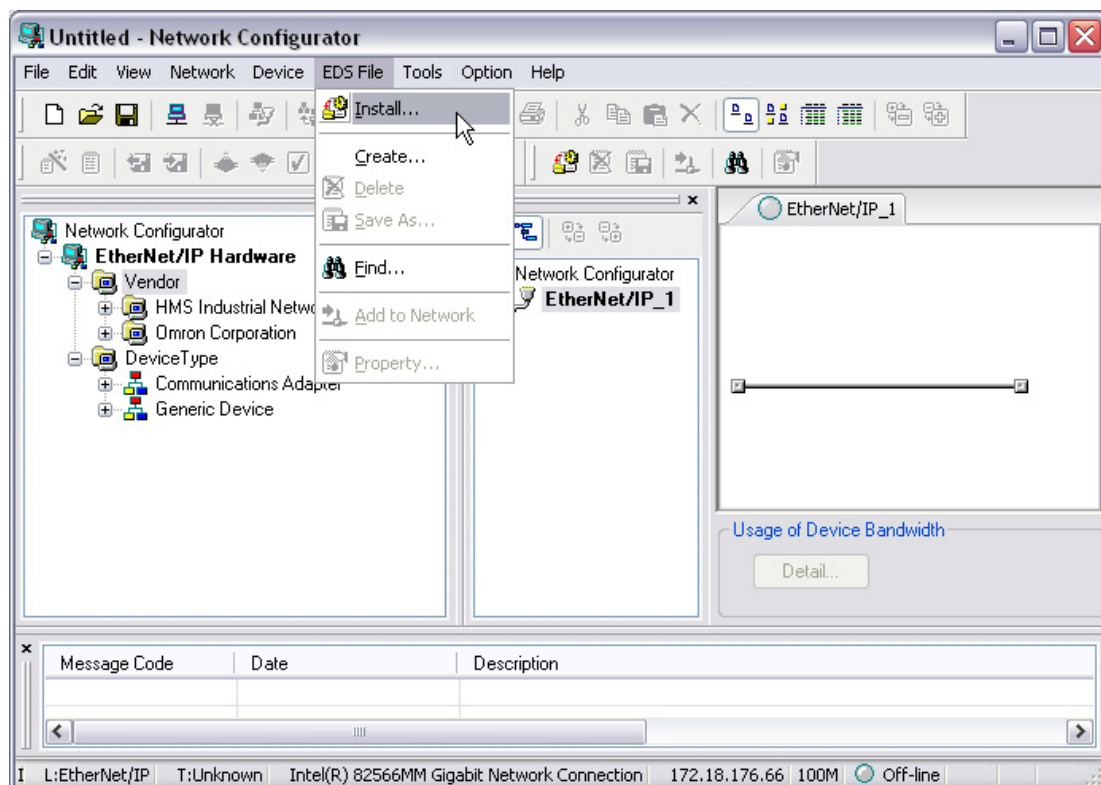

Figure 23. Controller Tags



## Omron Network Configurator

This configuration tool, unlike ControlLogix, requires an Electronic Data Sheet (.eds). This can be downloaded from <http://www.ssdrives.com> together with a matching icon (.ico).



Install the EDS file and icon. Now the 890 can then be added to the EtherNet IP network.

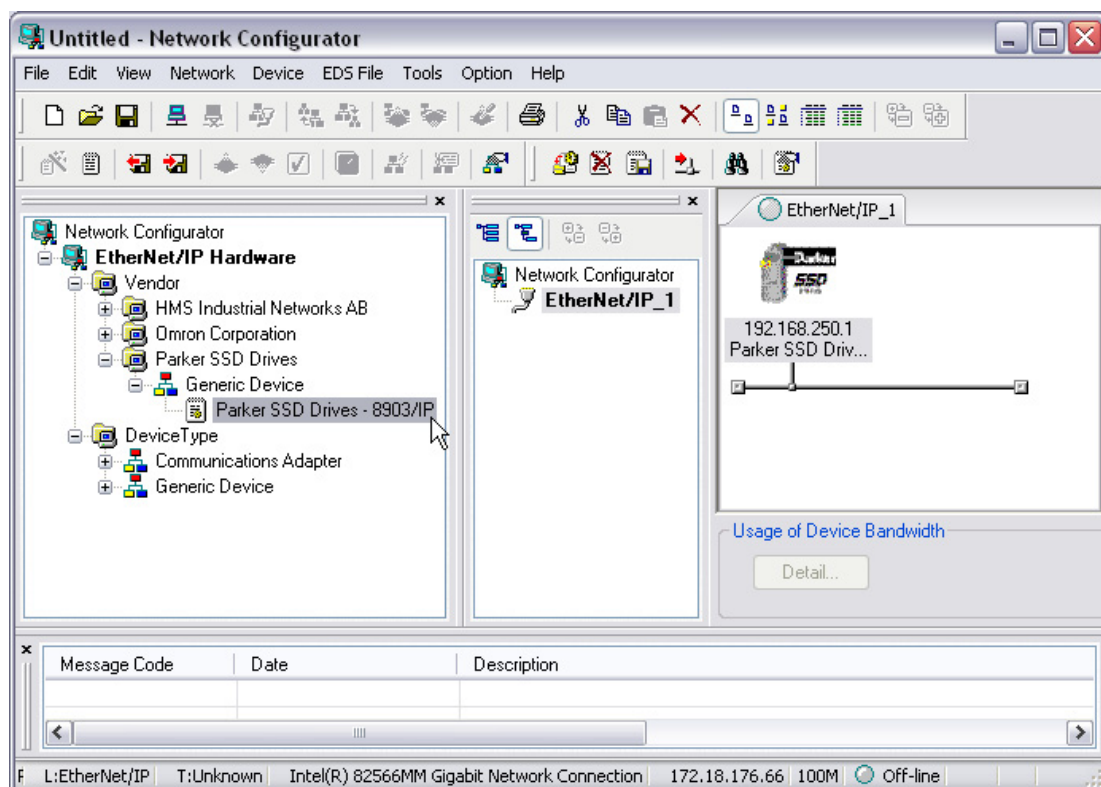

## Profinet/IO

### Siemens SIMATIC 300

Prior knowledge of the SIMATIC 300 PLC and SIMATIC Manager software is assumed. The following is an example of configuring the PLC; programming is left to the user.

1. Create a project.

Start **SIMATIC Manager** and create a new project. Right-click on the project name at the top level and from **Insert New Object** select **SIMATIC 300 Station**.

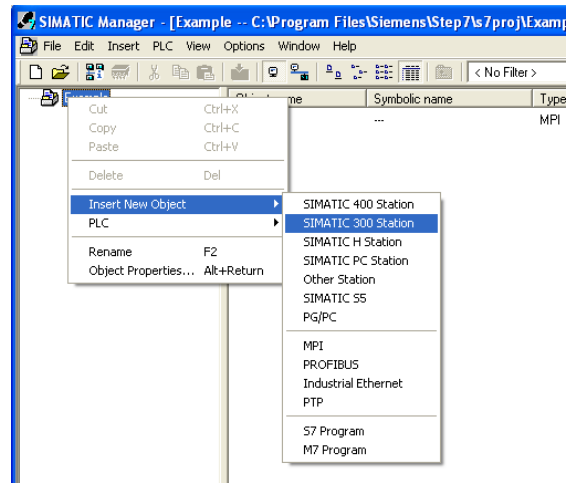

2. PLC interface

The interface to the PLC is selected by clicking on the **Options** menu and choosing **Set PG/PC Interface**.

In this example the interface chosen is via a PC Ethernet card.

Alternatively, a PC adapter (MPI or Profibus) may be used for the interface.

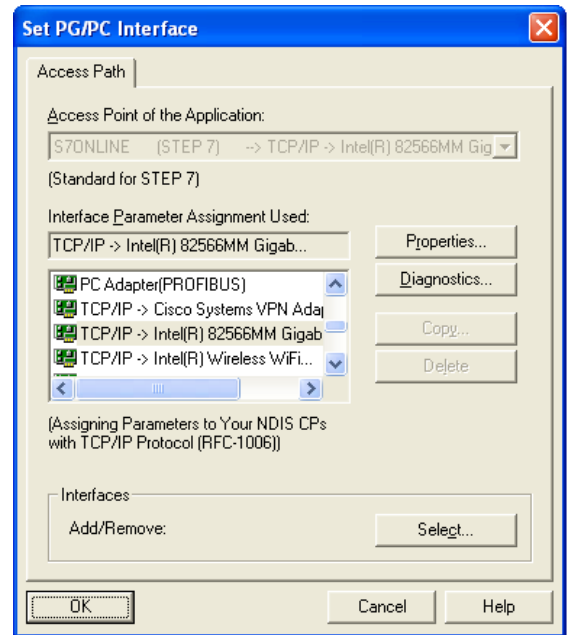

3. Start HW Config

To configure the PLC, right-click on **SIMATIC 300** and select **Open Object** to start **HW Config**.

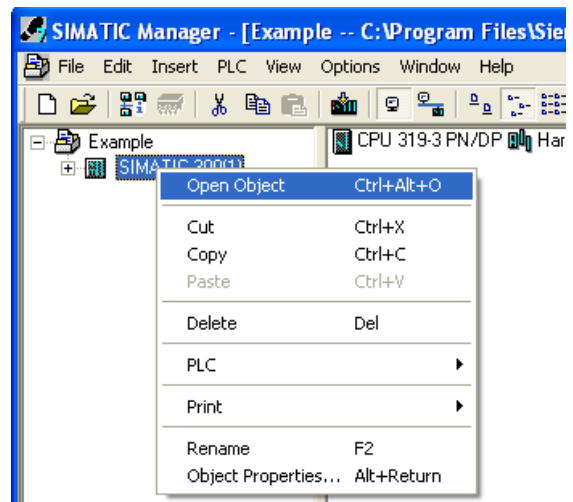

## 4. Configure the PLC hardware

In **HW Config**, select **Insert** from the menu followed by **Insert Object**. From the pop-up menu choose **SIMATIC 300** → **RACK-300** → **Rail**. The rail should then appear as shown.

Right-click on slot 1 to add the appropriate power supply.

Right-click on slot 2 to add the appropriate CPU.

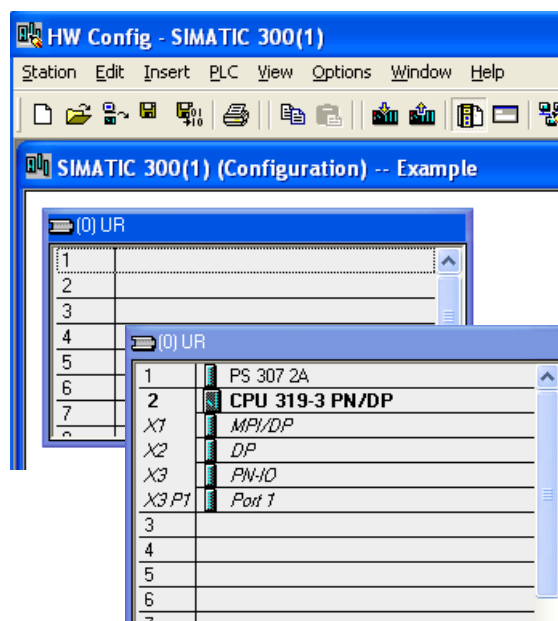

Double click on the Profinet IO (**PN-IO**) Controller module to reveal the dialog box. Click on **Properties...** to set up the IP address and Subnet mask.

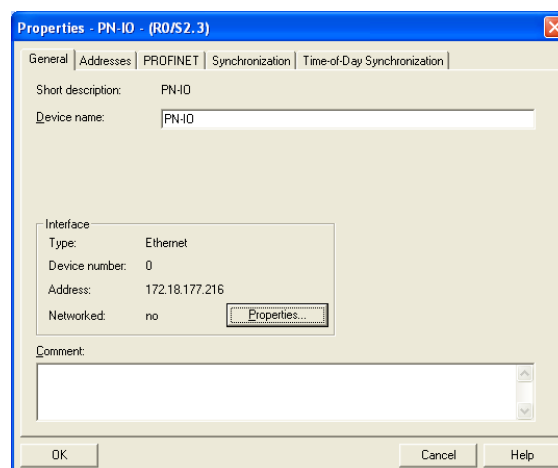

Click on **New...** to create a new network and select this. In this example **Ethernet(1)** has been selected.

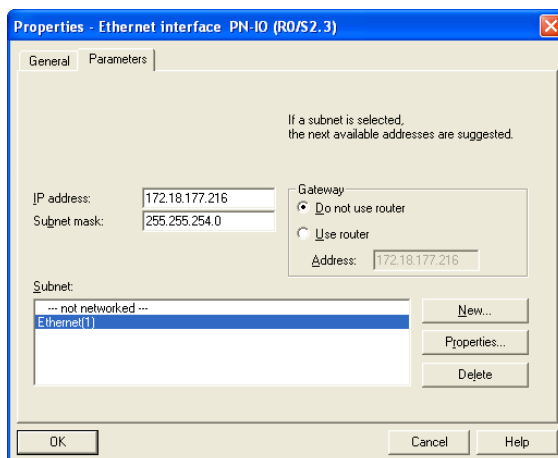

Right-click on the Profinet IO (PN-IO) Controller module and select **Insert PROFINET IO system**. The name of the Profinet IO system may be changed if required.

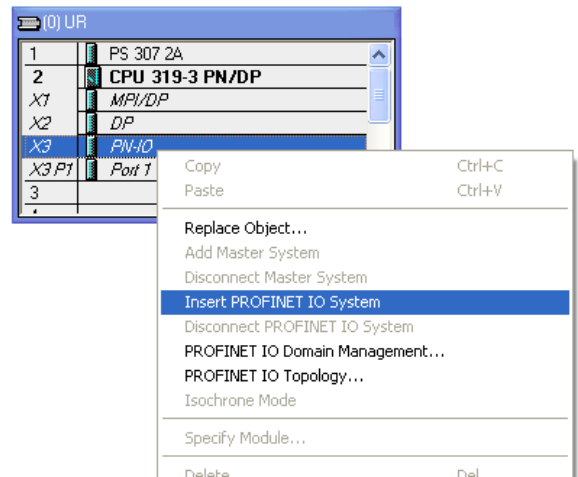

5. Install the GSD file

Install the 8903/PN Profinet IO GSD XML file and bitmap file. These files can be downloaded from <http://www.ssddrives.com>

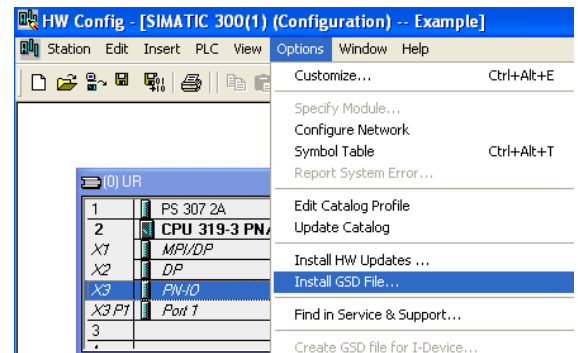

This will then become available in the **catalogue** shown on the right-hand side of the window under **PROFINET IO** → **Additional Field Devices** → **Parker SSD 8903**

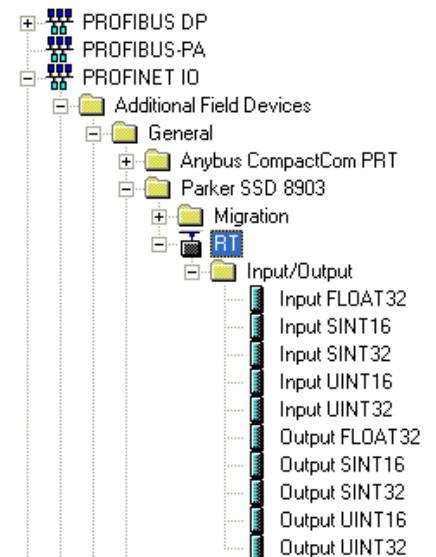

Click and drag the Device Access Point **RT** from the catalogue and drop onto the **Ethernet: Profinet IO System**. This represents the 890 Drive slave. If the IO controller does not support extended Profinet diagnostics, select the Device Access Point under **Migration** in the catalogue.

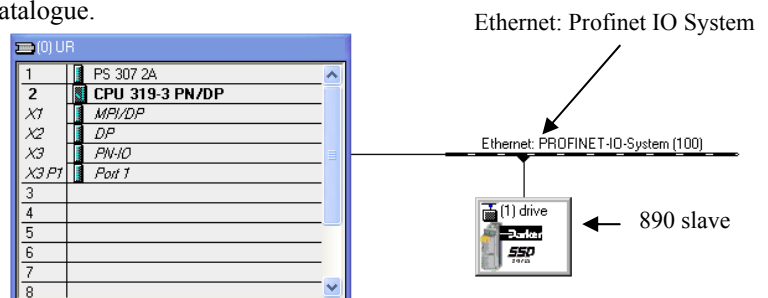

## 6. Configure the process data for the slave

By selecting the slave, the input and output process data may be configured. This must match the configuration in the DSE (including data types) with the **PLC output parameters coming first**, followed by the input parameters.

The appropriate inputs and outputs may be dragged from the catalogue and dropped into the appropriate slot.

The screenshot shows the HW Config window for a slave rack. The rack configuration is as follows:

Slot	Module
1	PS 307 2A
2	CPU 319-3 PN/DP
X1	MPI/DP
X2	DP
X3	PN-IO
X3 PT	Port 1
3	
4	
5	
6	
7	
8	

The diagram shows the rack connected to an Ethernet PROFINET-IO-System (100) with a drive connected to the system.

Slot	Module	Order Number ...	I Address	Q address	Diagnostic...	Comment
0	drive	SSD8903-PN			8186*	
X1	Interface				8185*	
P1	Port 1				8184*	
1	Output SINT16	SSD8903-PN		256...257		
2	Output SINT16	SSD8903-PN		258...259		
3	Output UINT16	SSD8903-PN		260...261		
4	Output UINT16	SSD8903-PN		262...263		
5	Output FLOAT32	SSD8903-PN		264...267		
6	Output FLOAT32	SSD8903-PN		268...271		
7	Output SINT32	SSD8903-PN		272...275		
8	Output SINT32	SSD8903-PN		276...279		
9	Output UINT32	SSD8903-PN		280...283		
10	Output UINT32	SSD8903-PN		284...287		
11	Input SINT16	SSD8903-PN	256...257			
12	Input SINT16	SSD8903-PN	258...259			
13	Input UINT16	SSD8903-PN	260...261			
14	Input UINT16	SSD8903-PN	262...263			
15	Input FLOAT32	SSD8903-PN	264...267			
16	Input FLOAT32	SSD8903-PN	268...271			
17	Input SINT32	SSD8903-PN	272...275			
18	Input SINT32	SSD8903-PN	276...279			
19	Input UINT32	SSD8903-PN	280...283			
20	Input UINT32	SSD8903-PN	284...287			
21						
22						

The corresponding DSE configuration is shown here.

The screenshot shows the EN (355487.001:Ethernet) configuration window. The input and output registers are configured as follows:

Register	Input	Type	Register	Output	Type
1	PAW256	SINT16	1	PEW256	SINT16
2	PAW258	SINT16	2	PEW258	SINT16
3	PAW260	UINT16	3	PEW260	UINT16
4	PAW262	UINT16	4	PEW262	UINT16
5	PAD264	FLOAT	5	PED264	FLOAT
6	PAD268	FLOAT	6	PED268	FLOAT
7	PAD272	SINT32	7	PED272	SINT32
8	PAD276	SINT32	8	PED276	SINT32
9	PAD280	UINT32	9	PED280	UINT32
10	PAD284	UINT32	10	PED284	UINT32

The General section shows the following parameters:

- Option Slot: A (top)
- 32bit order: High Word First
- IP Address: 172.18.177.224
- subnet mask: 255.255.254.0

7. Configure the slave

To configure the slave (890) double click on the slave icon. This allows the device name to be changed. In this example it is named **drive**.

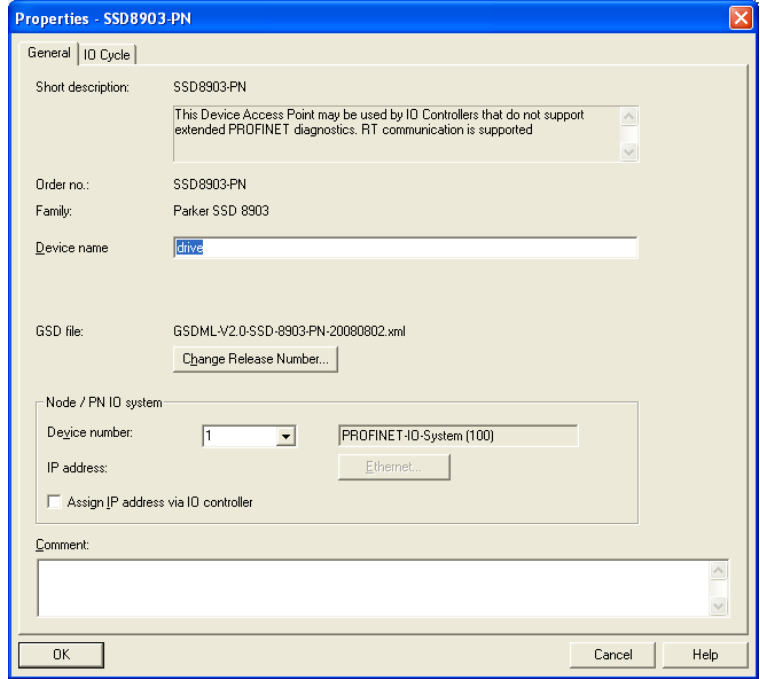

8. Assign the station name of the Profinet slave

Double-click on the **Ethernet: PROFINET IO-System** to reveal the dialog box. Make sure the check-box **Use Name in IO-Device / Controller** is cleared, otherwise the station name will require a dot extension.

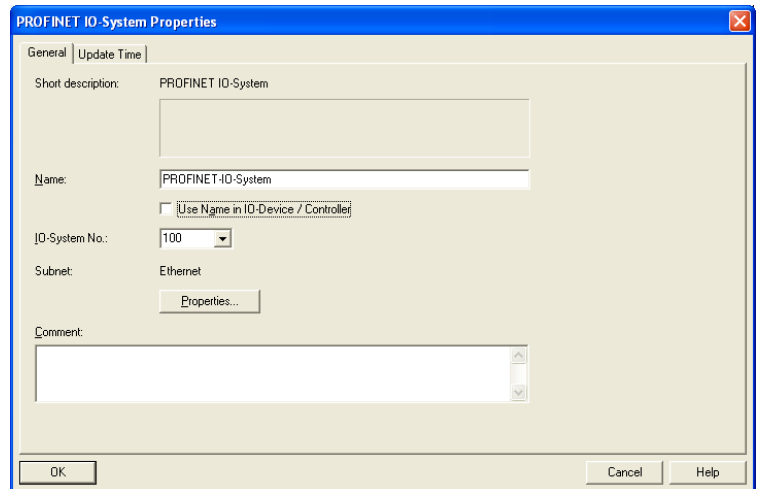

Select **PLC** from the menu and choose **Edit Ethernet Node...** to reveal the dialog box.

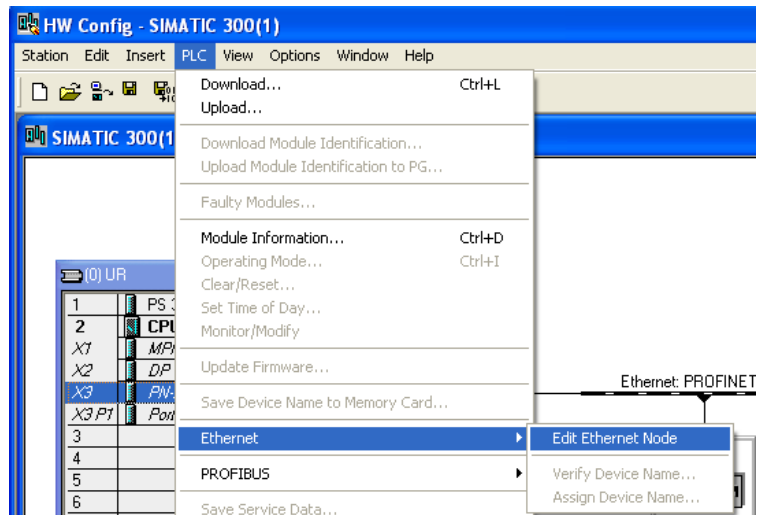

With the slave connected to the network, click **Browse...** to find the MAC address of the slave to be configured, select the device and click OK (alternatively type in the MAC address directly, if known).

Type in the **Device name** and click on **Assign Name**. This will set the slave Station Name. This must match that set in step 7 above.

The IP address of the slave may also be assigned here if it is not set using DSE.

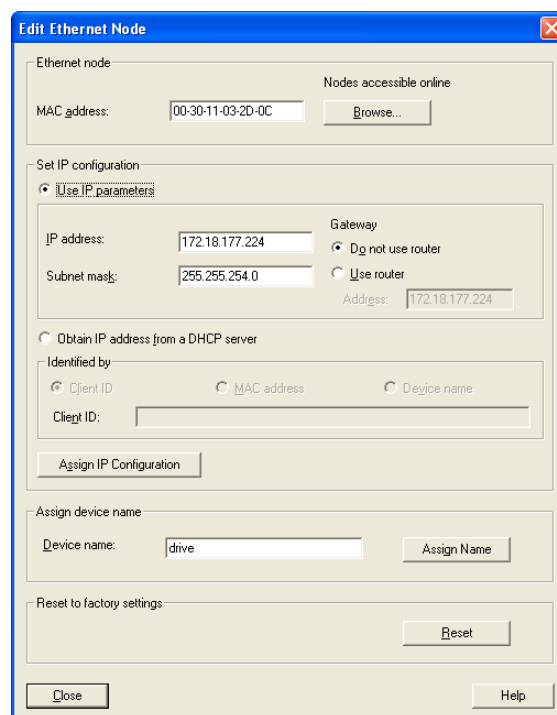

9. Save, compile and download

Make sure the PC/PLC interface is connected. Select **Station** from the menu and **Save and Compile** then select **PLC** and **Download...**

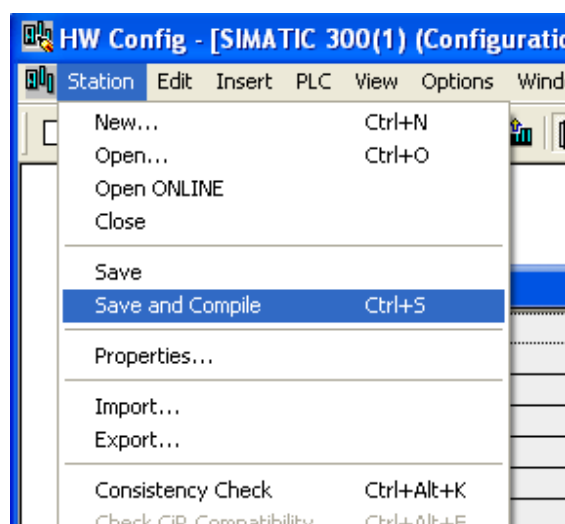

### Tips

- The Profinet IO only operates on a 100Mbit/s network.
- The Module Status (MS) LED will remain off until there is a physical connection to a network.
- The Module Status (MS) LED state will display 1 red flash if the configuration does not match the configuration in DSE. See Step 6 above.
- The Module Status (MS) LED state will display 2 red flashes if the IP address is not set. See Step 8 above.
- The Module Status (MS) LED state will display 3 red flashes if the station name is not set. See Step 8 above.
- A flashing Bus Fault (BF) LED on the PLC indicates that a module in the hardware configuration (HW Config) does not match the physical module or that the module is not connected to the network.
- The process data of the slave must be configured in the PLC so that the output parameters come first followed by the input parameters. See Step 6 above.
- The Device Name of the slave cannot be changed if there is an open connection to the PLC.

## Configuring DSE to Connect over Ethernet

It is possible to connect DSE to any 890 Drive with an Ethernet option to allow Configuration Installation, Update and On-Line Monitoring. This is an alternative to the USB connection, with the advantage of speed and remote connection. Note – it is not possible to Install Firmware over Ethernet, this must always be done over USB.

Click on the Comm Port icon and select IP.

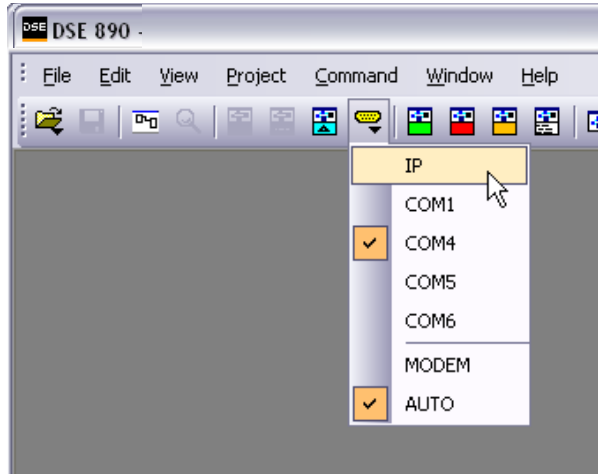

Enter IP address of 890 Drive to connect to.

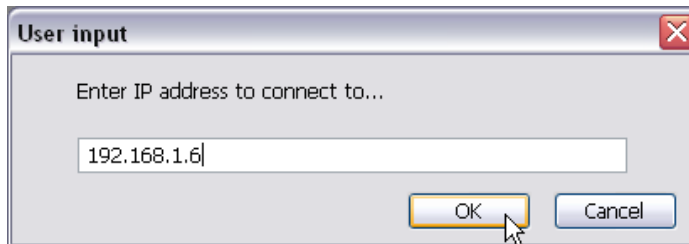

If a 890 Drive is already connected on the same LAN as the PC running DSE when DSE is launched, the Drive will appear in the list of available Comm Ports.

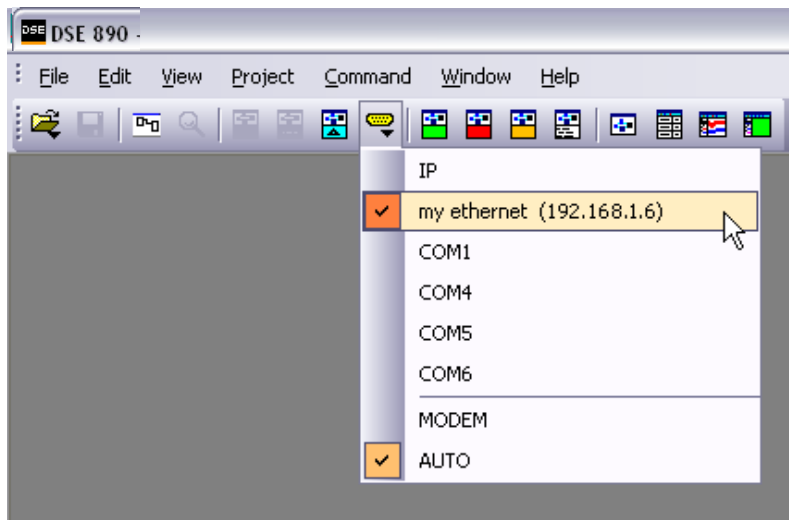



## Appendix A: Network States

### Modbus TCP/IP

State	Description
NOT ACTIVE	Waiting for Modbus TCP/IP requests
ACTIVE	A Modbus TCP/IP request addressed to this node has been received within the specified Connection Timeout time. This time defaults to 0 (disabled) but can be set by writing to Holding Register 0516 (204h). The value is in milliseconds.
IDLE	This state can be entered by writing a non-zero value to Holding Register 0517 (205h)
FAULT	Fatal error. Further Modbus TCP/IP requests will be ignored

### Ethernet IP

State	Description
WAIT TO CONNECT	Waiting for a Class 1 connection to be opened
ERROR	<ul style="list-style-type: none"> <li>• Class 1 connection error</li> <li>• Duplicate IP address detected</li> </ul>
RUNNING	Error free Class 1 connection active (RUN-bit set in the 32-bit Run/Idle header of an Exclusive Owner connection).
IDLE	Class 1 connection idle
EXCEPTION	Unexpected error. Major fault.

### Profinet IO

State	Description
WAIT TO CONNECT	Waiting for IO connection with an IO controller to be opened
ERROR	Configuration data mismatch or initial parameter error
RUNNING	IO connection established with IO controller
STOPPED	IO controller with which an IO connection is established is in STOP mode
EXCEPTION	Unexpected behaviour. Ethernet MAC held in reset..

## Appendix B : DSE/Ethernet Conversion Rules

The rules governing the conversion between DSE data types and Ethernet data types are given below. Note carefully that some conversions will result in rounding, limiting and truncation of the original value

### LOGIC Type Connector

	Data from PLC	Data to DSE
<b>From SINT16 to LOGIC</b>	Zero Non-zero	False True
<b>From SINT32 to LOGIC</b>	Zero Non-zero	False True
<b>From UINT16 to LOGIC</b>	Zero Non-zero	False True
<b>From UINT32 to LOGIC</b>	Zero Non-zero	False True
<b>From FLOAT to LOGIC</b>	Zero Non-zero	False True

	Data from DSE	Data to PLC
<b>From LOGIC to SINT16</b>	False True	0 1
<b>From LOGIC to SINT32</b>	False True	0 1
<b>From LOGIC to UINT16</b>	False True	0 1
<b>From LOGIC to UINT32</b>	False True	0 1
<b>From LOGIC to FLOAT</b>	False True	0.0 1.0

### INTEGER Type Connector

	Data from PLC	Data to DSE
<b>From SINT16 to INTEGER</b>	-32,768 to 32,767	-32,768 to 32,767
<b>From SINT32 to INTEGER</b>	-2,147,483,648 to 2,147,483,547	-2,147,483,648 to 2,147,483,547
<b>From UINT16 to INTEGER</b>	0 to 65,535	0 to 65,535
<b>From UINT32 to INTEGER</b>	0 to 4,294,967,295	0 to 2,147,483,647 limits apply
<b>From FLOAT to INTEGER</b>	32-bit IEEE floating-point	-2,147,483,648 to 2,147,483,547 Fractional part rounded

	Data from DSE	Data to PLC
<b>From INTEGER to SINT16</b>	-2,147,483,648 to 2,147,483,647	-32768 to 32767 limits apply
<b>From INTEGER to SINT32</b>	-2,147,483,648 to 2,147,483,647	-2,147,483,648 to 2,147,483,647
<b>From INTEGER to UINT16</b>	-2,147,483,648 to 2,147,483,647	0 to 65,535 limits apply
<b>From INTEGER to UINT32</b>	-2,147,483,648 to 2,147,483,647	0 to 2,147,483,647 limits apply
<b>From INTEGER to FLOAT</b>	-2,147,483,648 to 2,147,483,647	32-bit IEEE floating-point

**VALUE Type Connector**

	<b>Data from PLC</b>	<b>Data to DSE</b>
<b>From SINT16 to VALUE</b>	-32,768 to 32,767	-32,768.0 to 32,767.0
<b>From SINT32 to VALUE</b>	-2,147,483,648 to 2,147,483,547	-32,768.0 to 32,767.0 limits apply
<b>From UINT16 to VALUE</b>	0 to 65,535	0.0 to 32,767.0 limits apply
<b>From UINT32 to VALUE</b>	0 to 4,294,967,295	0.0 to 32,767.0 limits apply
<b>From FLOAT to VALUE</b>	32-bit IEEE floating-point	-32,768.0 to 32,767.9999 limits apply

	<b>Data from DSE</b>	<b>Data to PLC</b>
<b>From VALUE to SINT16</b>	-32,768.0 to 32,767.9999	-32,768 to 32,767 limits apply/ rounding applies
<b>From VALUE to SINT32</b>	-32,768.0 to 32,767.9999	-32768 to 32,767 limits apply/ rounding applies
<b>From VALUE to UINT16</b>	-32,768.0 to 32,767.9999	0 to 32767 limits apply/ rounding applies
<b>From VALUE to UINT32</b>	-32,768.0 to 32,767.9999	0 to 32767 limits apply/ rounding applies
<b>From VALUE to REAL</b>	-32,768.0 to 32,767.9999	32-bit IEEE floating- point

ISS.	MODIFICATION	ECN No.	DATE	DRAWN	CHK'D
1	Initial Issue (HA500522U002) Addition of Profinet Option and protocol information: 8903/PN	20633	05/05/09	CM	MF
2	Page 3 Replaced photo, now showing STO. Page 17 Added "Default 0 ... "Network States". Replaced TechCard with Option. Other minor corrections and amendments	(20808)			
		20814	11 Feb 10	FEP	MF
FIRST USED ON		MODIFICATION RECORD 8903/IM, 8903/IP and 8903/PN Ethernet Communications Interfaces			
		DRAWING NUMBER  ZZ500522C002			SHT. 1  OF 1