



Option Modules

Profibus DP-V1 Communications Option

HA501837U001 Issue 1
Technical Manual

aerospace
climate control
electromechanical
filtration
fluid & gas handling
hydraulics
pneumatics
process control
sealing & shielding



AC30 Profibus DP-V1 Option

Technical Manual HA501837U001 Issue 1

Copyright 2012 Parker Hannifin Manufacturing Limited

All rights strictly reserved. No part of this document may be stored in a retrieval system, or transmitted in any form or by any means to persons not employed by a Parker company without written permission from Parker Hannifin Ltd. Although every effort has been taken to ensure the accuracy of this document it may be necessary, without notice, to make amendments or correct omissions. Parker cannot accept responsibility for damage, injury, or expenses resulting therefrom.

Parker Hannifin Manufacturing Limited is referred to throughout this document as Parker.

WARRANTY

The general terms and conditions of sale of goods and/or services of Parker Hannifin Europe Sàrl's, Luxembourg, Switzerland Branch, Etoy, apply to this product unless otherwise agreed. The terms and conditions are available on our website www.parker.com/termsandconditions/switzerland.

FAILURE OR IMPROPER SELECTION OR IMPROPER USE OF THE PRODUCTS DESCRIBED HEREIN OR RELATED ITEMS CAN CAUSE DEATH, PERSONAL INJURY AND PROPERTY DAMAGE.

This document and other information from Parker-Hannifin Corporation, its subsidiaries and authorized distributors provide product or system options for further investigation by users having technical expertise.

The user, through its own analysis and testing, is solely responsible for making the final selection of the system and components and assuring that all performance, endurance, maintenance, safety and warning requirements of the application are met. The user must analyze all aspects of the application, follow applicable industry standards, and follow the information concerning the product in the current product catalog and in any other materials provided from Parker or its subsidiaries or authorized distributors.

To the extent that Parker or its subsidiaries or authorized distributors provide component or system options based upon data or specifications provided by the user, the user is responsible for determining that such data and specifications are suitable and sufficient for all applications and reasonably foreseeable uses of the components or systems.

The above disclaimer is being specifically brought to the user's attention and is in addition to and not in substitution to the Exclusions and Limitations on Liability which are set out in the terms and conditions of sale.

Safety Information



Requirements

IMPORTANT: Please read this information BEFORE installing the equipment.

Intended Users

This manual is to be made available to all persons who are required to install, configure or service equipment described herein, or any other associated operation.

The information given is intended to highlight safety issues, EMC considerations, and to enable the user to obtain maximum benefit from the equipment.

Complete the following table for future reference detailing how the unit is to be installed and used.

INSTALLATION DETAILS	
Model Number (see product label)	
Where installed (for your own information)	

Application Area

The equipment described is intended for industrial motor speed control utilising AC induction or AC synchronous machines.

Personnel

Installation, operation and maintenance of the equipment should be carried out by competent personnel. A competent person is someone who is technically qualified and familiar with all safety information and established safety practices; with the installation process, operation and maintenance of this equipment; and with all the hazards involved.

Product Warnings

 DANGER Risk of electric shock	 WARNING Hot surfaces	 Caution Refer to documentation	 Earth/Ground Protective Conductor Terminal
---	--	--	--

CAUTION!

APPLICATION RISK

- The specifications, processes and circuitry described herein are for guidance only and may need to be adapted to the user's specific application. We cannot guarantee the suitability of the equipment described in this Manual for individual applications.

RISK ASSESSMENT

Under fault conditions, power loss or unintended operating conditions, the drive may not operate as intended. In particular:

- Stored energy might not discharge to safe levels as quickly as suggested, and can still be present even though the drive appears to be switched off
- The motor's direction of rotation might not be controlled
- The motor speed might not be controlled
- The motor might be energised

A drive is a component within a drive system that may influence its operation or effects under a fault condition. Consideration must be given to:

- Stored energy
- Supply disconnects
- Sequencing logic
- Unintended operation

Safety Information



DANGER! - Ignoring the following may result in injury

1. This equipment can endanger life by exposure to rotating machinery and high voltages.
2. The equipment must be permanently earthed due to the high earth leakage current, and the drive motor must be connected to an appropriate safety earth.
3. Ensure all incoming supplies are isolated before working on the equipment. Be aware that there may be more than one supply connection to the drive.
4. There may still be dangerous voltages present at power terminals (motor output, supply input phases, DC bus and the brake, where fitted) when the motor is at standstill or is stopped.
5. For measurements use only a meter to IEC 61010 (CAT III or higher). Always begin using the highest range. CAT I and CAT II meters must not be used on this product.
6. Allow at least 5 minutes for the drive's capacitors to discharge to safe voltage levels (<50V). Use the specified meter capable of measuring up to 1000V dc & ac rms to confirm that less than 50V is present between all power terminals and between power terminals and earth.
7. Unless otherwise stated, this product must NOT be dismantled. In the event of a fault the drive must be returned. Refer to "Routine Maintenance and Repair".

WARNING! - Ignoring the following may result in injury or damage to equipment

SAFETY

Where there is conflict between EMC and Safety requirements, personnel safety shall always take precedence.

- Never perform high voltage resistance checks on the wiring without first disconnecting the drive from the circuit being tested.
- Whilst ensuring ventilation is sufficient, provide guarding and /or additional safety systems to prevent injury or damage to equipment.
- When replacing a drive in an application and before returning to use, it is essential that all user defined parameters for the product's operation are correctly installed.
- All control and signal terminals are SELV, i.e. protected by double insulation. Ensure all external wiring is rated for the highest system voltage.
- Thermal sensors contained within the motor must have at least basic insulation.
- All exposed metalwork in the Inverter is protected by basic insulation and bonded to a safety earth.
- RCDs are not recommended for use with this product but, where their use is mandatory, only Type B RCDs should be used.

EMC

- In a domestic environment this product may cause radio interference in which case supplementary mitigation measures may be required.
- This equipment contains electrostatic discharge (ESD) sensitive parts. Observe static control precautions when handling, installing and servicing this product.
- This is a product of the restricted sales distribution class according to IEC 61800-3. It is designated as "professional equipment" as defined in EN61000-3-2. Permission of the supply authority shall be obtained before connection to the low voltage supply.

Disposal

Waste Electrical and Electronic Equipment (WEEE)



Waste Electrical and Electronic Equipment - must not be disposed of with domestic waste.

It must be separately collected according to local legislation and applicable laws.



Parker Hannifin Company, together with local distributors and in accordance with EU directive 2002/96/EC, undertakes to withdraw and dispose of its products, fully respecting environmental considerations.

For more information about how to recycle your Parker supplied waste equipment, please contact your local Parker Service Centre.

Packaging

During transport our products are protected by suitable packaging. This is entirely environmentally compatible and should be taken for central disposal as secondary raw material.

Contents	Page No.
AC30 Profibus DP-V1 Option	1
Introduction	1
Features	1
The Product Code	1
Installation.....	2
Connecting to the Profibus Network	4
Wiring Diagram Example	7
LEDs.....	7
Operation (OP) Mode LED.....	7
Status (ST) LED.....	7
Configuration.....	8
Node Address	8
Process Data	8
Example Configuration	10
Configuration Summary	10
Example Using a SIMATIC PLC.....	10
Configuring the AC30.....	14
Acyclic Data Exchange.....	16
Overview.....	16
Parameter Read / Write with Call	17
Example Acyclic Data Exchange	19
Lost Communications Trip.....	21
Supervised Parameter	21
Comms Break Trip.....	21
Diagnostic Event	22
Parameters	23
Configuration Parameters	23
Runtime Parameters	25
Diagnostic Parameters.....	26
Troubleshooting	30
Hardware Mismatch.....	30
Invalid Configuration	30
PLC Indication	30
Appendix A – Array Parameter Numbers.....	31
Array Example	31
Appendix B – Data Types.....	31

AC30 PROFIBUS DP-V1 OPTION

Introduction

Features

- Profibus DP-V1
- Up to 12Mbps transmission rate
- Galvanically isolated bus via DB9F female connector
- Status and Operation Mode LEDs
- Up to a total of 152 bytes of cyclic I/O data
- Up to 68 bytes of Class 1 and Class 2 acyclic data
- Up to 152 bytes of configuration data
- GSD file provided

The Product Code

The product code for the Profibus DP-V1 Option is:

7003-PB-00

Installation

1. Remove the Graphical Keypad (GKP) by pulling from the top down, and remove.

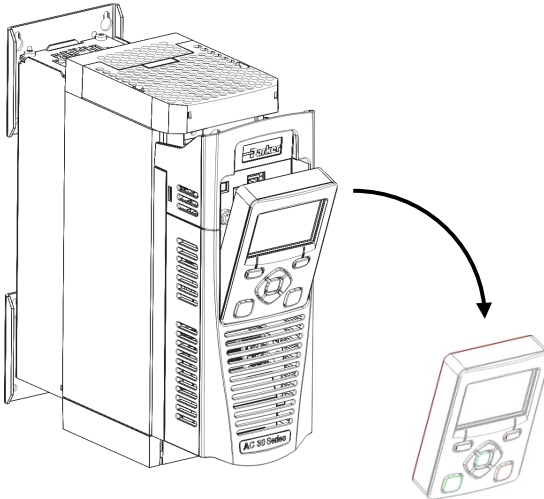

2. After removing the screw slide the control module lower cover down slightly and then remove.

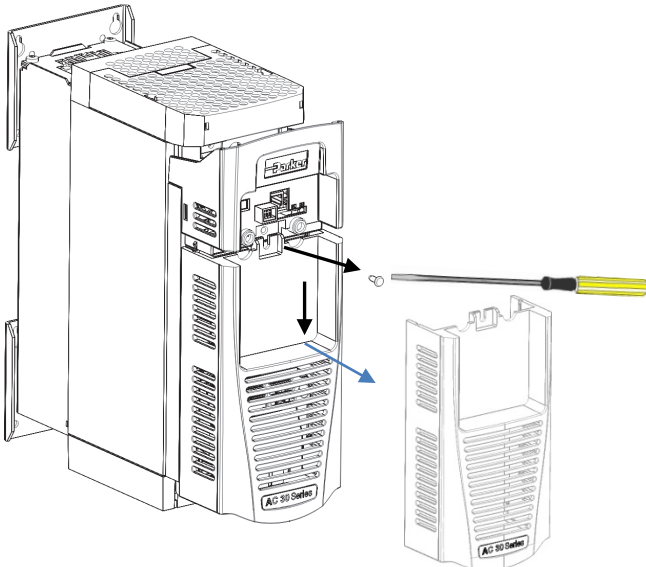

3. Click the Option into place and tighten the retaining screw, as shown.

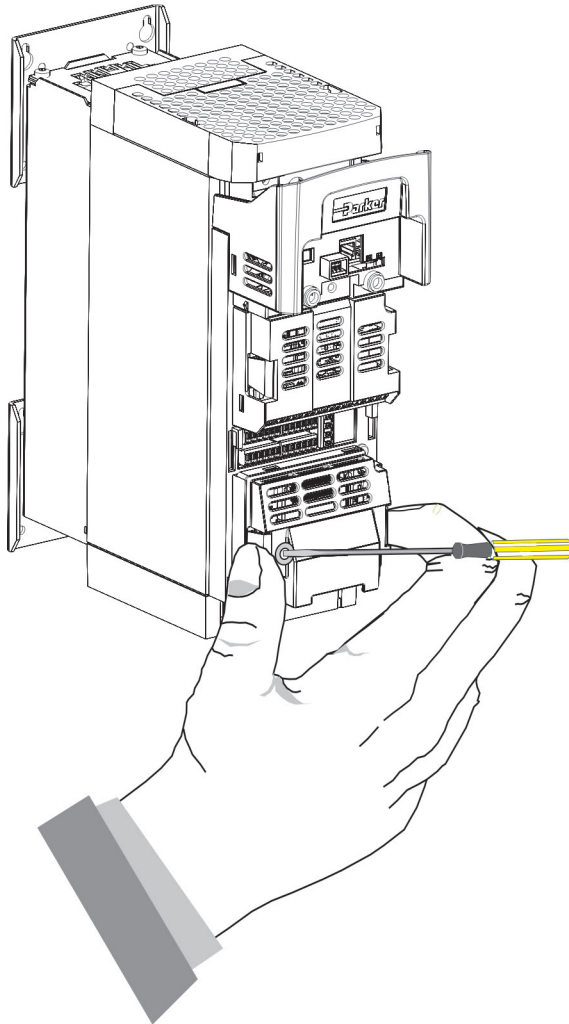

4. Slide and click back the control module lower cover, tighten the retaining screw and slot back the GKP

Connecting to the Profibus Network

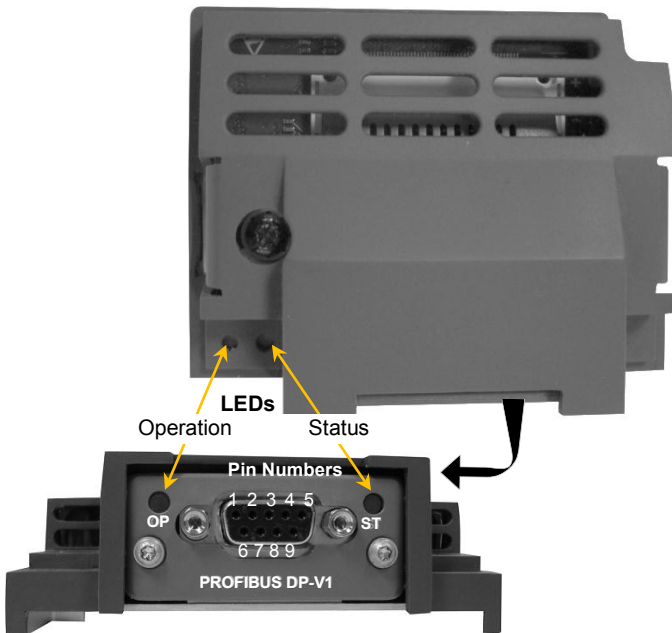

Pin	Signal	Description
1	-	
2	-	
3	B Line	Positive RxD/TxD RS485 level
4	RTS	Request to send
5	GND Bus	Isolated ground
6	+5V Bus Output	Isolated +5V termination (short-circuit protected)
7	-	
8	A Line	Negative RxD/TxD RS485 level
9	-	
Housing	Cable Shield	Connected to protective earth via a filter

Note: It is possible to make serial communications operate without adhering to the following recommendations; however, the recommendations will promote greater reliability.

Cable Specification

PROFIBUS DP-V1 cable uses a specific colour code (red/green). You should maintain this colour code throughout your network. The cable has a single twisted pair with overall shielding.

The bus line is specified in IEC 61158 and it can be used in accordance with the table below.

Cable Parameters	PROFIBUS line
Surge impedance in Ω	135 ... 165
Capacitance per unit length (pF/m)	< 30
Loop resistance (Ω /km)	110
Core diameter (mm)	0.64
Core cross-section (mm ²)	> 0.34

Note: Belden B3079E cable meets the above specification.

PROFIBUS DP-V1 Connectors

You should use connectors recommended by Profibus. These connectors will have a shield clamp providing shield continuity and will help to ensure good noise immunity of your network.

We recommend the use of the horizontal Erbic range of PROFIBUS-DP connectors from ERNI:

- ◆ ERNI Part number 103648, grey - used on all nodes in the middle of the network
- ◆ ERNI Part number 103649, yellow - termination connector
- ◆ ERNI Part number 134728, grey - includes switchable termination

For further information, visit www.erni.com

Terminators

Failure to terminate a network correctly can reduce the noise immunity of the network and affect performance.

A termination resistor must be fitted at each end of the network to prevent interference.

If too many resistors are fitted to the network, the resulting reduced signal levels may cause nodes to miss bits of information. If network overload becomes excessive, the reduced signal levels may prevent the nodes from detecting any activity.

Connect terminating resistors to the end drives as shown below. (All resistors $\pm 5\%$, minimum $\frac{1}{4}$ Watt).

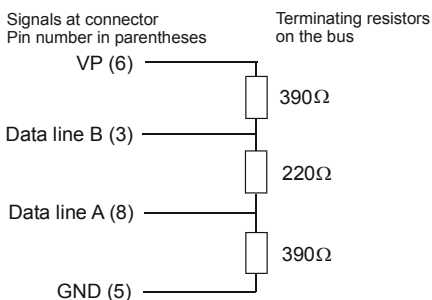

Repeaters

The maximum number of nodes allowed on a single PROFIBUS DP-V1 network segment is 32. A repeater can be used to extend the network length and/or to allow more than 32 nodes to be connected.

Note: CNTR-P (Pin Number 4) is a TTL level signal that can be connected to a repeater. Most repeaters automatically switch between transmitting and receiving and so do not need this connection.

Wiring Diagram Example

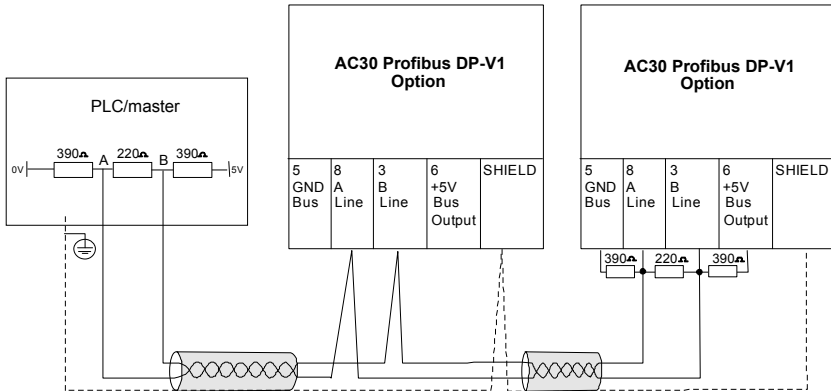

LEDs

Operation (OP) Mode LED

State	Indication
Off	Not online / No power
Green	Online, data exchange
Flashing Green	Online, clear
Flashing Red (1 flash)	Parameterization error
Flashing Red (2 flashes)	Configuration error

Status (ST) LED

State	Indication
Off	No power or not initialised
Green	Initialised
Flashing Green	Initialised, diagnostic event present
Red	Exception error

Configuration

The option requires configuration of the slave node address and mapping of the process data to the master. The baud rate is detected automatically. Note that some communication parameters only become active after the AC30 leaves the configuration state.

The **0044 Comms Required** parameter must be set to **PROFIBUS DPV1**.

Node Address

The **0238 Profibus Node Address** parameter must be set to the required address for the slave. The range is the 0 -125. If the address is set to 126 then the SSA (Set Slave Address) will be used, which enables a master or configuration tool to set the node address.

Note: The default value is 0. This value should be changed before connecting to a network.

Process Data

The cyclic I/O data is configured by using the read and write process data mapping tables in the AC30. These tables are two parameter arrays in which AC30 parameter numbers may be added.

At least one AC30 parameter must be mapped to the process data. String-type parameters may not be mapped.

Read Mapping

The read process data represents cyclic data sent from the PLC to the AC30. Only writable AC30 parameters, that are not configuration parameters, may be added to the read process data.

Write Mapping

The write process data represents cyclic data sent from the AC30 to the PLC.

Mapping Arrays

Parameter arrays may be added into the process data, however this could lead to large amounts of data being passed across the communications. An alternative is to only reference the element(s) of the array required. This is possible as each element of a parameter array has its own parameter number. See the [Appendix A– Array Parameter Numbers](#).

Default Mapping

The process data mapping will contain a factory default mapping. The default mapping may be overwritten if required.

Modules

The GSD file defines a number of modules. When configuring the PLC, the modules may be added to the slave device slots as required. These modules map to the process data in the order in which they are added.

The modules relevant to the AC30 are:

Module	Maps to parameter
Input 1 byte	Write process data – 1-byte parameters
Input 1 word	Write process data – 2-byte parameters
Input 2 words	Write process data – 4-byte parameters
Output 1 byte	Read process data – 1-byte parameters
Output 1 word	Read process data – 2-byte parameters
Output 2 words	Read process data – 4-byte parameters

The size of a parameter may be determined from its data type. The relationship between the AC30 parameter and Profibus data types is given in [Appendix B – Data Types](#).

If parameter arrays are to be included in the process data mapping, then add as many modules as there are indexes in the array. Each module must be the same size as the element of the array.

Cyclic Data Exchange

Cyclic data exchange will occur when an MS0 connection is established, i.e. when the Profibus State is IDLE (master mode = clear) or PROCESS ACTIVE (master mode = operate). However, the read process data will only update the mapped parameters when in the PROCESS ACTIVE state.

On a transition into the PROCESS ACTIVE state all read process mapped parameters will be updated.

When in the PROCESS ACTIVE state the read process mapped parameters will all update only when a change in the read process data occurs.

Example Configuration

Configuration Summary

Communications Settings	
Node Address	3

Read Process Mapping Table	Data Type	Bytes	PLC Module	
000	0627 Comms Control Word	WORD	2	Output 1 word
001	0628 Comms Reference	REAL	4	Output 2 words
002	000			
003	000			

Write Process Mapping Table	Data Type	Bytes	PLC Module	
000	0661 Status Word	WORD	2	Input 1 word
001	0395 Actual Speed Percent	REAL	4	Input 2 words
002	000			
003	000			

Example Using a SIMATIC PLC

Prior knowledge of the SIMATIC 300 PLC and SIMATIC Manager software is assumed. The following is an example of configuring the PLC.

1. Create a project.

Start **SIMATIC Manager** and create a new project. Right-click on the project name at the top level and from **Insert New Object** select **SIMATIC 300 Station**.

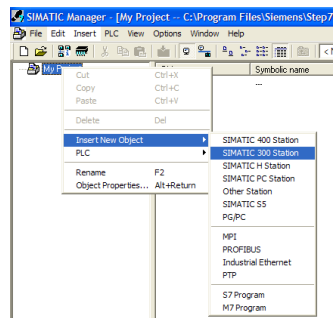

2. PLC Interface.

The interface between the PLC and PC is selected by clicking on the **Options** menu and choosing **Set PG/PC Interface**.

In this example the PC Adapter is chosen.

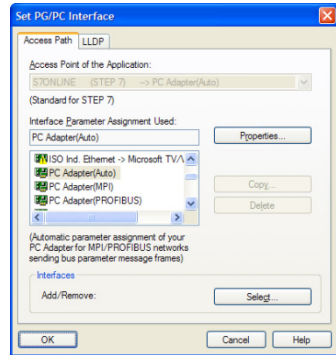

3. Start HW Config.

To configure the PLC, click on **SIMATIC 300** and double-click on **Hardware**. This will start **HW Config**.

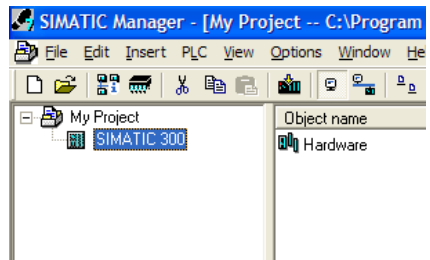

4. Configure the PLC hardware.

In **HW Config**, select **Insert** from the menu followed by **Insert Object**. From the pop-up menu choose **SIMATIC 300 → RACK 300 → Rail**. The rail should then appear as shown.

Right-click on slot 1 to add the appropriate power supply.

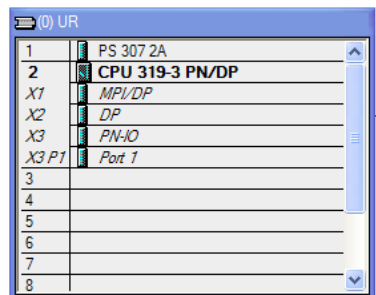

Right-click on slot 2 to add the appropriate CPU.

5. Install the GSD file.

Install the Profibus GSD file.
This can be downloaded from
www.parker.com/ssd

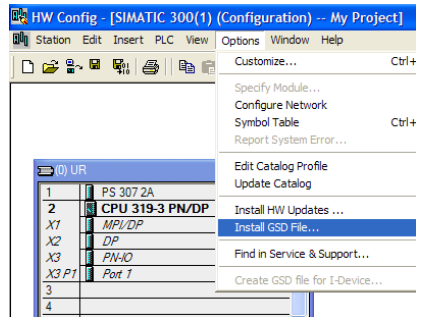

This will then become available in the catalogue shown on the right-hand side of the window under **PROFIBUS DP** → **Additional Field Devices** → **General** → **Anybus CompactCom DPV1**

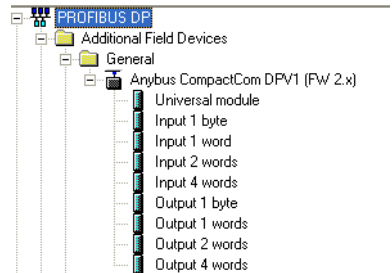

6. Add the Profibus Controller.

Right-click on the Profibus (DP) Controller module and select **Add Master System**. Double click on the **Profibus: DP master system** to modify the master node address, if required.

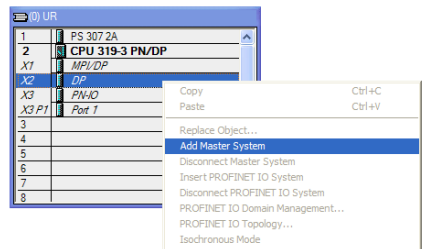

7. Add the slave.

Click and drag the Device from the catalogue and drop onto the **Profibus: DP master system**. This represents the AC30 option slave. When adding the slave device you can select its node address.

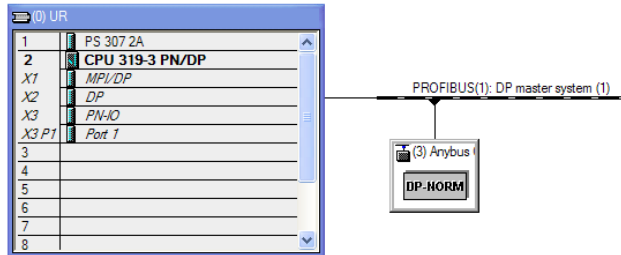

8. Configure the process data for the slave.

By selecting the slave, the input and output process data may be configured. This must match the configuration set up in the AC30.

The appropriate input and output modules may be dragged from the catalogue and dropped into the appropriate slot.

Slot	DP ID	Order Number / Dest...	I Address	Q Address	Comment
1	224	Output 1 words		256...257	
2	225	Output 2 words		258...261	
3	208	Input 1 word	256...257		
4	209	Input 2 words	258...261		
5					
6					

9. Save, compile and download.

Make sure the PC/PLC interface is connected. Select **Station** from the menu and **Save and Compile** then select **PLC** and **Download...**

Configuring the AC30

AC30 Parker Drive Quicktool (PDQ)

When performing an online configuration, the fitted option card will automatically be selected. In offline mode, parameter **0044 Comms required** must be set to PROFIBUS DPV1:

 Create a New Drive - Drive

Choose a Task | Drive | Application | Motor | Motor Control | Input/Output

Power Stack	4.5A 400V
 Comms Required	PROFIBUS DPV1
Range :	NONE
Type of communication option required by application	BACNET IP
IO Option Type	BACNET MSTP
Drive Name	CANOPEN
	CC LINK
	CONTROLNET
	DEVICENET
	ETHERCAT
	ETHERNET IP
	MODBUS RTU
	MODBUS TCP
	PROFIBUS DPV1
	PROFINET IO

Set the **0238 Profibus Node Address** parameter to the required address:

 Profibus Node Address	<input type="text" value="0"/>
Range : 0 ---> 126	
Node address	

Add the required parameters to the Read Process Mapping table (parameter **0055 Read Mapping**) by selecting them from the popup window:

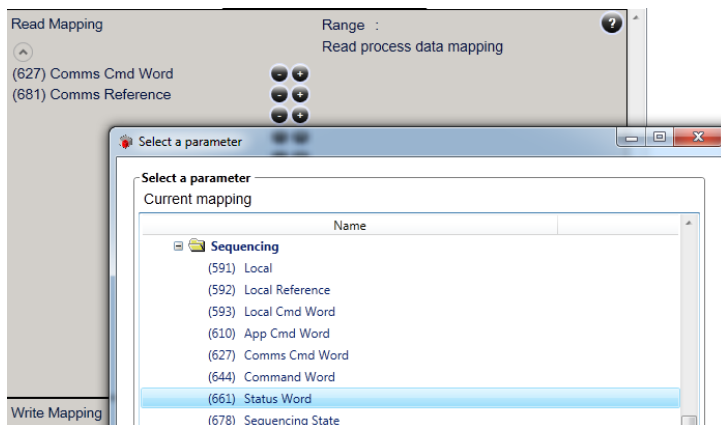

Add the required parameters to the Write Process Mapping table (parameter **0120 Write Mapping**) by selecting them from the popup window:

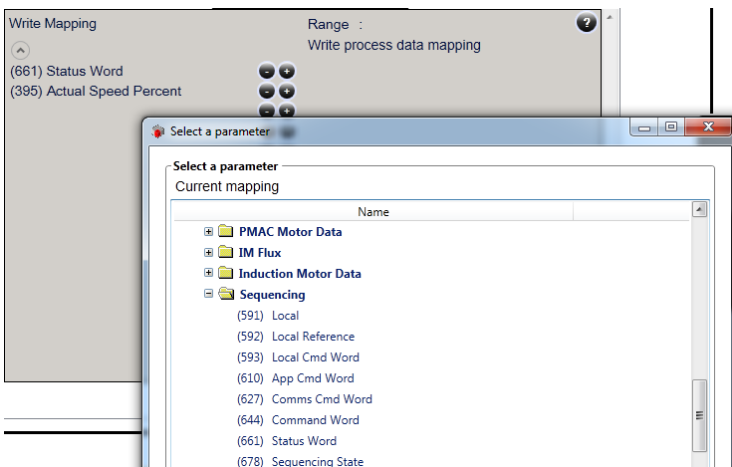

Note the Process Data mapping ends on the first empty entry.

Acyclic Data Exchange

AC30 parameters may be accessed acyclically from the network using DP-V1 MS1/MS2 read / write services.

Overview

The AC30 parameters are mapped to slots and indexes as follows:

parameter number = slot * 255 + index + 1
 slot = (parameter number - 1) / 255
 index = (parameter number - 1) MODULO 255

- The Class 1 and Class 2 Request buffers are each 68 bytes.
- When reading more data than the actual size of the parameter, the response will only contain the actual parameter data without any additional padding.
- When reading less data than the actual size of the parameter, only the requested amount of data is returned.
- Parameter arrays may be accessed; either as a whole or as individual elements. [See the Appendix A– Array Parameter Numbers.](#)
- Parameter string arrays must be accessed by each element. Attempting to access the whole array will only return the first element.
- The following relevant read / write error codes may be returned:

Error Code 1	Error Code 2	Error Type	Description
0xB0	0x04	Invalid index	Parameter number out of range
0xB1	0x0A	Write error length	Too much data
0xB1	0x0B	Write error length	Not enough data
0xB6	0x08	Access denied	Parameter not writable
0xB6	0x09	Access denied	Parameter not readable
0xB7	0x0C	Invalid range	Value out of range

Parameter Read / Write with Call

The Parameter Read/Write with Call enables addressing of parameters based on the parameter number rather than Slot and Index. This uses a DP-V1 write service (function 5Fh) request followed by a DP-V1 read service (function 5Eh) response. The read / write service uses Slot 00h, Index FFh.

Parameter Read Call

The following service request translates to a request to read a parameter:

Byte #	Contents	Field	Value
1	DP-V1 Header	Function no. of write service	5Fh
2		Slot	00h
3		Index	FFh
4		Length of telegram	06h
5	Call	External function no.	08h
6		Reserved	00h
7		Sub-index (high)	00h
8		Sub-index (low)	02h
9		Parameter number (high byte)	0000h...
10		Parameter number (low byte)	FFFFh

The following service translates to the response:

Byte #	Contents	Field	Value
1	DP-V1 Header	Function no. of read service	5Eh
2		Slot	00h
3		Index	FFh
4		Length of telegram	06h...F0h
5	Call	External function no.	08h
6		Reserved	00h
7		Sub-index (high)	00h
8		Sub-index (low)	02h
9		Parameter number (high byte)	0000h...
10		Parameter number (low byte)	FFFFh
11...n	Data		

Parameter Write Call

The following service request translates to a request to write to a parameter:

Byte #	Contents	Field	Value
1	DP-V1 Header	Function no. of write service	5Fh
2		Slot	00h
3		Index	FFh
4		Length of telegram	06h...F0h
5	Call	External function no.	08h
6		Reserved	00h
7		Sub-index (high)	00h
8		Sub-index (low)	01h
9		Parameter number (high byte)	0000h...
10		Parameter number (low byte)	FFFFh
11...n	Data		

The following service translates to the response:

Byte #	Contents	Field	Value
1	DP-V1 Header	Function no. of read service	5Eh
2		Slot	00h
3		Index	FFh
4		Length of telegram	06h
5	Call	External function no.	08h
6		Reserved	00h
7		Sub-index (high)	00h
8		Sub-index (low)	01h
9		Parameter number (high byte)	0000h...
10		Parameter number (low byte)	FFFFh

Example Acyclic Data Exchange

Example using a SIMATIC PLC

The DP-V1 read and write services may be achieved using the functions SFB52 RDREC and SFB53 WRREC.

In this example a parameter of length 2 bytes will be read using the Parameter Read Call.

First, using the WRREC, the parameter number is passed, as shown below.

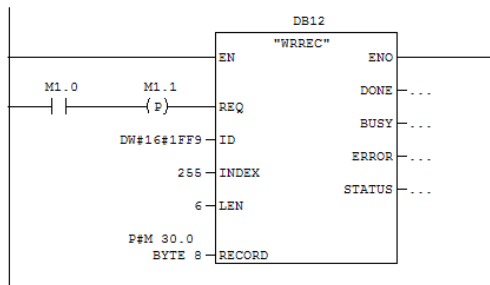

The INDEX is set to 255 as required by the Call. The ID in this case is set to 1FF9h (8185) which is the diagnostic address found in Slot 0. LEN sets the required length of the telegram.

The call request is sent is pointed to by the RECORD parameter. This record will contain the request telegram as given in the previous section, with the last two bytes representing the parameter number, in this case 563 (0233h).

08h	00h	00h	02h	02h	33h
-----	-----	-----	-----	-----	-----

The data from parameter 563 can then be read using the RDREC.

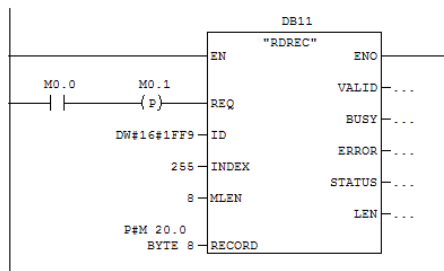

The RECORD parameter will hold the response telegram, the length of which will be 8 bytes which includes the two bytes of the read parameter data. The expected response would be as shown below with the last two bytes representing the parameter data.

08h	00h	00h	02h	02h	33h	data	data
-----	-----	-----	-----	-----	-----	------	------

Lost Communications Trip

Supervised Parameter

The **0047 Comms Supervised** parameter indicates that the Profibus network participation is supervised by another Profibus device.

The Supervised parameter value is set to TRUE when either:

- The Parameterisation and configuration data have been accepted (MS0 connection established)
- An MS2 connection is open

The Supervised parameter will subsequently change to FALSE if the connection is closed or the Profibus watchdog (if enabled) has timed out.

Comms Break Trip

The Comms Break trip will generate a trip if a break in communications is detected. A trip event will be generated when a transition from TRUE to FALSE of the parameter **0047 Comms Supervised** occurs.

To enable the Comms Break trip, the parameter **0048 Comms Trip Enable** must be set to TRUE *and* the **COMMS BREAK** bit set in the parameter **0697 Enable 1-32**.

For more information on enabling trips see Chapter 10 Trips & Fault Finding in the AC30 Product Manual HA501718U001.

Diagnostic Event

A single diagnostic event may be created. This adds a status PDU to the Extended Diagnostics. The severity is fixed as Minor Recoverable.

Four AC30 parameters are associated with the diagnostic event:

0185 Comms Event Code

This code will be used in the status PDU in the diagnostics. This corresponds to the status diagnostic message in the GSD file. For example, code 0x10 represents "Generic Error".

0187 Comms Event Set

A rising edge signal from FALSE to TRUE will create a diagnostic event. The **Comms Event Clear** parameter must be set FALSE.

0188 Comms Event Clear

A rising edge signal from FALSE to TRUE will remove a diagnostic event. The **Comms Event Set** parameter must be set to FALSE.

0186 Comms Event Active

This parameter indicates if a diagnostic event is active or not.

Note: The rising edge signals for Comms Event Set and Comms Event Clear must be held for at least 10ms in FALSE and at least 10ms in TRUE to take effect.

When a diagnostic event is active the Status LED will flash green.

Parameters

Configuration Parameters

0044 Comms Required		Range	RW	Saved	Config
Type	USINT (enumerated)	(1) NONE	✓	✓	✓
Default	NOT FITTED	(2) BACNET IP			
Communications option parameter. Sets the required communications option.		(3) BACNET MSTP			
		(4) CANOPEN			
		(5) CC LINK			
		(6) CONTROLNET			
		(7) DEVICENET			
		(8) ETHERCAT			
		(9) ETHERNET IP			
		(10) MODBUS RTU			
		(11) MODBUS TCP			
		(12) PROFIBUS DPV1			
		(13) PROFINET IO			

0238 Profibus Node Address		Range	RW	Saved	Config
Type	USINT	0	✓	✓	✓
Default	0	...			
Profibus communications option parameter. Sets the required node address. If set to 126 then the SSA (Set Slave Address) will be used.		126			

0055 Read Mapping		Range	RW	Saved	Config
Type	Array of UINT	0 ... Last parameter number	✓	✓	✓
Default	0				
<p>Communications option parameter.</p> <p>Sets the required read process data mapping.</p> <p>Each entry in the table represents the required parameter number.</p>					

0120 Write Mapping		Range	RW	Saved	Config
Type	Array of UINT	0 ... Last parameter number	✓	✓	✓
Default	0				
<p>Communications option parameter.</p> <p>Sets the required write process data mapping.</p> <p>Each entry in the table represents the required parameter number.</p>					

0048 Comms Trip Enable		Range	RW	Saved	Config
Type	BOOL	FALSE TRUE	✓	✓	x
Default	FALSE				
<p>Communications option parameter.</p> <p>Enables the communications trip.</p>					

Runtime Parameters

0185 Comms Event Code		Range	RW	Saved	Config
Type	BYTE	0x00 ... 0xFF	✓	x	x
Default	0				
Communications option parameter. Sets the event code to be used when a diagnostic event is created.					

0187 Comms Event Set		Range	RW	Saved	Config
Type	BOOL	FALSE TRUE	✓	x	x
Default	FALSE				
Communications option parameter. A rising edge (FALSE to TRUE) will create a diagnostic event.					

0188 Comms Event Clear		Range	RW	Saved	Config
Type	BOOL	FALSE TRUE	✓	x	x
Default	TRUE				
Communications option parameter. A rising edge (FALSE to TRUE) will remove a diagnostic event.					

Diagnostic Parameters

0045 Comms Fitted		Range
Type	USINT (enumerated)	(0) UNKNOWN
		(1) NONE
Communications option parameter.		(2) BACNET IP
Indicates the communications option fitted.		(3) BACNET MSTP
		(4) CANOPEN
		(5) CC LINK
		(6) CONTROLNET
		(7) DEVICENET
		(8) ETHERCAT
		(9) ETHERNET IP
		(10) MODBUS RTU
		(11) MODBUS TCP
		(12) PROFIBUS DPV1
		(13) PROFINET IO

0046 Comms State		Range
Type	USINT (enumerated)	(0) SETUP – setup in progress
		(1) NW INIT – network-related initialisation tasks are being performed
Communications option parameter.		(2) WAIT PROCESS – no MS0 connection
Indicates the state of the communications option fitted.		(3) IDLE – MS0 established / MS2 connection may be open (master mode = clear)
		(4) PROCESS ACTIVE– MS0 established / MS2 connection may be open (master mode = operate)
		(5) ERROR – network error
		(6) RESERVED
		(7) EXCEPTION – unrecoverable error
		(8) NONE – option not fitted

0237 Profibus State		Range
Type	USINT (enumerated)	(0) SETUP – setup in progress (1) NW INIT – network-related initialisation tasks are being performed (2) WAIT PROCESS – no MS0 connection (3) IDLE – MS0 established / MS2 connection may be open (master mode = clear) (4) PROCESS ACTIVE– MS0 established / MS2 connection may be open (master mode = operate) (5) ERROR – network error (6) RESERVED (7) EXCEPTION – unrecoverable error (8) NONE – option not fitted
Profibus communications option parameter. Indicates the state of the communications option fitted as the parameter 0046 Comms State , but specifically for Profibus.		

0047 Comms Supervised		Range
Type	BOOL	FALSE TRUE
Communications option parameter. Indicates that the Profibus network participation is supervised by another Profibus device.		

0049 Comms Module Version		Range
Type	DWORD	0x00000000 ... 0xFFFFFFFF The most significant byte is the major version number, followed by the minor version number. The least significant byte is the build number.
Communications option parameter. Firmware version of the option communications module.		

0050 Comms Module Serial		Range
Type	DWORD	0x00000000 ... 0xFFFFFFFF
Communications option parameter. Serial number of the option communications module.		

0051 Comms Diagnostic		Range
Type	USINT (enumerated)	(0) NONE (1) HARDWARE MISMATCH – required communications option does not match that fitted, or no option fitted but one is required. (2) INVALID CONFIGURATION – the configuration of the option is not valid. (3) MAPPING FAILED – the process data mapping is not permitted, e.g. adding read-only parameters to the read process data mapping. (4) EXCEPTION – configuration error (5) UNSUPPORTED OPTION – the fitted option is not currently supported
Communications option parameter. Indicates the state of the communications option fitted.		

0052 Comms Diagnostic Code		Range
Type	DWORD	0x00000000 ... 0xFFFFFFFF
Communications option parameter. Diagnostic code associated with the Diagnostic parameter.		

0053 Comms Exception		Range
Type	BYTE	0x00 ... 0xFF
Communications option parameter. Exception code associated with the Diagnostic parameter being in EXCEPTION		

0054 Comms Net Exception		Range
Type	BYTE	0x00 ... 0xFF
Communications option parameter. Network specific exception code associated with the Diagnostic parameter being in EXCEPTION		

0186 Comms Event Active		Range
Type	BOOL	FALSE TRUE
Communications option parameter. Indicates a diagnostic event is active.		

Troubleshooting

Configuration problems can often be identified by looking at the Operation Mode and Status LEDs and from the **Profibus State** and **Comms Diagnostic** parameters. Under normal operating conditions the parameter **Comms Diagnostic** should indicate NONE. Other values are summarized in the Diagnostic Parameters section.

Hardware Mismatch

Diagnostic = HARDWARE MISMATCH

- The required option does not match the actual fitted option.
- No option is fitted but one is required.

Invalid Configuration

Diagnostic = INVALID CONFIGURATION

- Invalid read or write process data mapping
- No read or write process data mapped
- Invalid communication settings

Diagnostic = MAPPING FAILED

- Attempting to map a parameter that does not exist.
- Attempting to map a configuration parameter.
- Attempting to map a string parameter.
- Attempting to map a read-only parameter to the read process data.

Diagnostic = INVALID CONFIGURATION and Status LED Red and

Exception = 0x06 and

Net Exception = 0x04

- Process data mapping exceeds total size of 152 bytes

Operation LED Flashing Red (2 flashes)

- The AC30 configuration and mapping does not match that of the PLC.

PLC Indication

Flashing Bus Fault (BF) LED on the PLC.

- A module in the hardware configuration (HW Config) does not match the physical module or that the module is not connected to the network.

Appendix A – Array Parameter Numbers

Some parameters have multiple elements and are classified as parameter arrays. A parameter array has a parameter number that accesses the *whole* of the array. It also has parameter numbers that represent each *element* of the array.

Array Example

A parameter array called **My Array** has 4 elements.

Parameter Number	Parameter - My Array
0152	Whole array
0153	index 0
0154	index 1
0155	index 2
0156	index 3

If the parameter number of the whole array is 0152, then the parameter number of the element index 0 of the array will be 0153, the parameter number of the element index 01 will be 0154, etc.

Note that *string* array parameters access their elements via parameter numbers that are calculated in a different way. See the AC30 Product Manual HA501718U001 for more details.

Appendix B – Data Types

The relationship between AC30 parameter and Profibus data type is given in the table below.

AC30 Parameter		Profibus	
Data Type	Description	Data Type	Bytes
BOOL	Boolean	Boolean	1
SINT	Short integer	Integer8	1
INT	Integer	Integer16	2
DINT	Double integer	Integer32	4
USINT	Unsigned short integer	Unsigned8	1
UINT	Unsigned integer	Unsigned16	2
UDINT	Unsigned double integer	Unsigned32	4
REAL	Floating point	Floating Point (32-bit IEEE-754)	4
TIME	Duration	Unsigned32	4
DATE	Date	Unsigned32	4
TIME_OF_DAY	Time of day	Unsigned32	4
DATE_AND_TIME	Date and time of day	Unsigned32	4
STRING	String	Visible string	<i>n</i>
BYTE	Bit string length 8	Unsigned8	1
WORD	Bit string length 16	Unsigned16	2
DWORD	Bit string length 32	Unsigned32	4

Parker Worldwide

AE – UAE, Dubai
Tel: +971 4 8127100
parker.me@parker.com

AR – Argentina, Buenos Aires
Tel: +54 3327 44 4129

AT – Austria, Wiener Neustadt
Tel: +43 (0)2622 23501-0
parker.austria@parker.com

AT – Eastern Europe, Wiener Neustadt
Tel: +43 (0)2622 23501 900
parker.eastereurope@parker.com

AU – Australia, Castle Hill
Tel: +61 (0)2-9634 7777

AZ – Azerbaijan, Baku
Tel: +994 50 2233 458
parker.azerbaijan@parker.com

BE/LU – Belgium, Nivelles
Tel: +32 (0)67 280 900
parker.belgium@parker.com

BR – Brazil, Cachoeirinha RS
Tel: +55 51 3470 9144

BY – Belarus, Minsk
Tel: +375 17 209 9399
parker.belarus@parker.com

CA – Canada, Milton, Ontario
Tel: +1 905 693 3000

CH – Switzerland, Etoy
Tel: +41 (0)21 821 87 00
parker.switzerland@parker.com

CL – Chile, Santiago
Tel: +56 2 623 1216

CN – China, Shanghai
Tel: +86 21 2899 5000

CZ – Czech Republic, Klecany
Tel: +420 284 083 111
parker.czechrepublic@parker.com

DE – Germany, Kaarst
Tel: +49 (0)2131 4016 0
parker.germany@parker.com

DK – Denmark, Ballerup
Tel: +45 43 56 04 00
parker.denmark@parker.com

ES – Spain, Madrid
Tel: +34 902 330 001
parker.spain@parker.com

FI – Finland, Vantaa
Tel: +358 (0)20 753 2500
parker.finland@parker.com

FR – France, Contamine s/Arve
Tel: +33 (0)4 50 25 80 25
parker.france@parker.com

GR – Greece, Athens
Tel: +30 210 933 6450
parker.greece@parker.com

HK – Hong Kong
Tel: +852 2428 8008

HU – Hungary, Budapest
Tel: +36 1 220 4155
parker.hungary@parker.com

IE – Ireland, Dublin
Tel: +353 (0)1 466 6370
parker.ireland@parker.com

IN – India, Mumbai
Tel: +91 22 6513 7081-85

IT – Italy, Corsico (MI)
Tel: +39 02 45 19 21
parker.italy@parker.com

JP – Japan, Tokyo
Tel: +81 (0)3 6408 3901

KR – South Korea, Seoul
Tel: +82 2 559 0400

KZ – Kazakhstan, Almaty
Tel: +7 7272 505 800
parker.eastereurope@parker.com

MX – Mexico, Apodaca
Tel: +52 81 8156 6000

MY – Malaysia, Shah Alam
Tel: +60 3 7849 0800

NL – The Netherlands, Oldenzaal
Tel: +31 (0)541 585 000
parker.nl@parker.com

NO – Norway, Asker
Tel: +47 66 75 34 00
parker.norway@parker.com

NZ – New Zealand, Mt Wellington
Tel: +64 9 574 1744

PL – Poland, Warsaw
Tel: +48 (0)22 573 24 00
parker.poland@parker.com

PT – Portugal, Leca da Palmeira
Tel: +351 22 999 7360
parker.portugal@parker.com

RO – Romania, Bucharest
Tel: +40 21 252 1382
parker.romania@parker.com

RU – Russia, Moscow
Tel: +7 495 645-2156
parker.russia@parker.com

SE – Sweden, Spånga
Tel: +46 (0)8 59 79 50 00
parker.sweden@parker.com

SG – Singapore
Tel: +65 6887 6300

SK – Slovakia, Banská Bystrica
Tel: +421 484 162 252
parker.slovakia@parker.com

SL – Slovenia, Novo Mesto
Tel: +386 7 337 6650
parker.slovenia@parker.com

TH – Thailand, Bangkok
Tel: +662 717 8140

TR – Turkey, Istanbul
Tel: +90 216 4997081
parker.turkey@parker.com

TW – Taiwan, Taipei
Tel: +886 2 2298 8987

UA – Ukraine, Kiev
Tel: +380 44 494 2731
parker.ukraine@parker.com

UK – United Kingdom, Warwick
Tel: +44 (0)1926 317 878
parker.uk@parker.com

US – USA, Cleveland
Tel: +1 216 896 3000

VE – Venezuela, Caracas
Tel: +58 212 238 5422

ZA – South Africa, Kempton Park
Tel: +27 (0)11 961 0700
parker.southafrica@parker.com

European Product Information Centre

Free phone: 00 800 27 27 5374

(from AT, BE, CH, CZ, DE, EE, ES, FI, FR, IE, IL, IS, IT, LU, MT, NL, NO, PT, SE, SK, UK)

© 2012 Parker Hannifin Corporation. All rights reserved.

**Parker Hannifin Manufacturing Limited,
Automation Group, SSD Drives Europe,**
New Courtwick Lane, Littlehampton,
West Sussex BN17 7RZ
United Kingdom
Tel: +44(0)1903 737000
Fax: +44(0)1903 737100
www.parker.com/ssd

