

AC M2n



AC Servo - Motors



**Product
Manual**

UL: 05-01-08



Product-Manual - Planetary Gearbox PG AP

UL: 05-01-06



Product-Manual - Planetary Gearbox PG APL

UL: 05-01-07



Product-Manual - Planetary Gearbox PG AF

UL: 05-02-01



Product-Manual - Planetary Gearbox PG NL

UL: 12-01



Product-Manual - Plugs

UL: 12-02-01



Product-Manual - Cables

UL: 12-02-01



Product-Manual - Cable-Set

©SSD Drives GmbH.

All rights reserved. No portion of this description may be produced or processed in any form without the consent of the company.

Changes are subject to change without notice.

SSD Drives has registered in part trademark protection and legal protection of designs. The handing over of the descriptions may not be construed as the transfer of any rights.

Made in Germany, 2006



	Page
The Most Important Thing First	4
1 General Information.....	5
1.1 Receipt of the Materials	5
1.2 Storage	5
1.3 Description.....	5
1.4 Model Code.....	6
1.4.1 Typical Example.....	6
1.5 Possible Options (Code: g).....	7
1.5.1 Standard	7
1.5.2 Special	8
2 Technical Data	9
2.1 General Technical Data	9
2.2 Power Supply 1 x 230VAC / 3 x 230VAC	10
2.3 Power Supply 1 x 400VAC	11
2.4 Torque/Speed Diagrams.....	12
2.4.1 Motor Size Y and 0	12
2.4.2 Motor Size 1.....	13
2.4.3 Motor Size 2.....	14
2.4.4 Motor Size 3.....	15
3 Dimensions	16
3.1 Connections with Cables and <u>PG - Gland</u> , Motor Size Y	16
3.2 Connections with <u>Plug - Design</u> , Motor Size 0 - 3	17
4 Connector Assignments	18
4.1 Terminal Connections for Motor Sizes BG 0 - 2.....	18
4.1.1 Terminal Connections for Motor Size BG 3	19
4.2 X50 – Terminal Connections for Motor Sizes BG 0 - 2	20
4.3 Resolver Connection	21
4.4 Wiring Instructions	22
4.5 Plug Designations	23
4.5.1 Mating connector for <u>Motor</u> and <u>Brake</u> Connections	23
4.5.2 Mating connector for <u>Resolver</u> and Thermal Connections	23
4.6 Cable Designations.....	23
4.6.1 Motor Cable	23
4.6.2 Resolver Cable	23
5 Holding Brake	24
5.1 Technical Data of the Holding Brake	24
6 Shaft Loads	25
6.1 Representation of the Definition	25
6.2 Technical Data of the Maximum Radial F_R (N) und Axial F_A (N) Shaft Loads (Rated Speed)	25
6.3 Ball Bearing Types Employed.....	25
7 Nominal Power - Dependence	26
7.1 Nominal Power – Dependence upon the Installation Altitude of the Servo Motor	26
8 Mounting / Installation.....	27
8.1 Security and Safety Instructions	27
8.2 Mounting and Installation Instructions	28
8.2.1 General Preparation	28
8.2.2 Mechanical Installation Preparation.....	28
8.2.3 Electrical Connections	28
8.2.4 Rotational Direction of the Servo Motor.....	28
9 Certifications.....	29
9.1 Manufacturer's Declaration.....	29
10 Modification Record	30

Thank you for your confidence in choosing our product.

These operating instructions are intended to provide an overview of the technical data and features of our products.

Please read the operating instructions completely before operating the product.

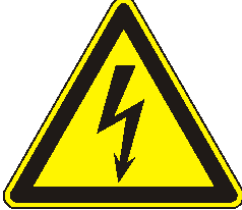
Should you have any questions, please contact your nearest SSD Drives representative.

	Improper application of this product in combination with dangerous high voltage can lead to serious injury or death.
	Damage can also occur to motors or other products. Therefore, we request that you strictly observe our safety and installation instructions.

Safety Precautions

We assume that as an expert, you are familiar with and will observe all of the relevant safety regulations, especially in accordance with VDE 0100, VDE 0113, VDE 0160, EN 50178, the accident prevention regulations of the employer's liability insurance company and the DIN regulations. Additionally, it is imperative that all relevant European Union Safety Directives be observed.

Depending on the kind of application, additional regulations, e.g. UL, DIN, must also be fully observed.

If our products are operated in connection with components from other manufacturers, their operating instructions are also subject to be strictly observed.

1.1 Receipt of the Materials

All servo motors have been completely checked before shipping.

- After carefully unpacking the materials, please check to make certain that the servo motor is in good condition.
- Please do not pull on the power cord when moving the servo motor.
- Please check that the information on the product name plate matches the specifications of your order.
- In the event that the product has been damaged during transport, it is imperative that the shipping company be notified of the problem within 24 hours of receipt of the materials.

Note: The package may contain other important documentation or additional parts.

1.2 Storage

If the servo motor is not going to be placed immediately in service, then it needs to be stored in an environment which is dry and has a constant temperature in order to prevent the risk of condensation. Should the motor be placed in storage for a longer period of time, it is important to make certain that the drive shaft and the surface of the flange are completely covered by a rust-proofing agent. After storage for a longer period of time, (more than 3 months), it is important to first operate the motor at a low speed to allow the grease to be evenly distributed within the motor.

1.3 Description

By utilizing high-energy magnetic materials it is possible to design small diameter disk motors. Due to the high-energy magnetic materials and the carefully optimized technical construction of the rotor, the motors have a low moment of inertia.

The stability of the magnetic material and the design of the magnetic field in opposition with demagnetization allow for maximum currents of up to **3- 4 times the rated current**.

This is the result of the high acceleration capacity of the low-inertia three-phase AC servo motors.

Through the permanent excitation of the magnets, no heat loss due to electrical current occurs within the rotor.

With the three-phase AC-servo motor, heat loss, due to electrical current, occurs only in the stator, which can then be directly drawn off.

These favorable cooling conditions allow for high-capacity windings.

Since all of the heat loss, due to electrical current, can be directly drawn from the surface, the motors can be designed at low cost, utilizing an enclosure type which provides protection in accordance with **IP xx**. The motors are therefore very resistant to moisture and dirt.

The resolver is built into B-side bearing bracket.

The signals for the integrated measuring system for the actual speed value, the rotor position and the indirect position are taken from the motor through a 12-pin connector.

Synchronous three-phase AC-servomotors have a number of advantages over DC motors:

- There are no electromechanical parts to wear out, and are therefore "maintenance-free".
- The low moment of inertia of the rotor, due to power density, allows for a high acceleration capacity.
- No commutation of the limit curve, providing for high acceleration moments in higher speed ranges as well.
- There are no heat losses in the rotor of the motor, providing for favorable thermal characteristics, in addition to a high degree of protection, due to the closed construction of the unit.

Three-phase AC-servomotors built in the way described, are specifically more efficient, (higher rated torque), than DC servomotors, and allow for operation at a lower moment of inertia. Therefore, the required motor size for a specific application will be smaller with a three-phase AC-servo motor than with a DC motor.

1.4 Model Code

Code	Standard						Optional	
	a	b	c	d	e	f	g	h
Model:	AC	<u>M2n</u>	XXX	-X	/X	-X	XXX	+...

Code	Description
a	AC = Three-phase
b	Motor Models: <u>M2n</u> = <u>Motor series 2 new version</u>
c	XXX = approx. rated torque in Ncm
d	Speed: -4 = 4000 1/min. -6 = 6000 1/min. (only available with motor type /Y) -X = additional configurations are available upon request (designation does not apply to motor / gearbox systems)
e	= Motor size (BG): /Y = BG Y, Flange □ 40 mm /0 = BG 0, Flange □ 55 mm /1 = BG 1, Flange □ 88 mm /2 = BG 2, Flange □ 105 mm /3 = BG 3, Flange □ 145 mm (designation does not apply to motor / gearbox systems)
f	-3 = 325 V DC intermediate circuit rated voltage (\cong 230 VAC) -6 = 565 V DC intermediate circuit rated voltage (\cong 400 VAC)
g	Identification for <u>standard</u> options and <u>special</u> options: XXX = see Chapter " Possible Options "
h	+ ... = with attached gearbox: (for a short description of potential gearbox types please consult gearbox documentation)

Note:

From code "g" forward -motor modifications are only available with options or custom features.

1.4.1 Typical Example

A typical example of an order corresponding to the model key code would be:

AC M2n0090-4/1-3

AC	= Three-phase
M2n	= <u>Motor series 2 new version</u>
0090	= Approx. rated torque in Ncm
-4	= 4000 rpm
/1	= Motor size BG 1, Flange □ 88 mm
-3	= 325 V DC intermediate circuit rated voltage (\cong 230 VAC)

1.5 Possible Options (Code: g)

1.5.1 Standard

Code	Options
GW0	Smooth motor shaft
BR0	Holding brake, 24V DC
BBR	Holding brake type B, 24V DC
P65	Degree of protection IP 65
BG0	Smooth motor shaft Holding brake, 24V DC
BBG	Smooth motor shaft Holding brake type B, 24V DC
AI0	Absolute or incremental encoder - preparation for attachment
BI0	Holding brake, 24V DC Absolute or incremental encoder - preparation for attachment
PL0	Electrical connections via PG couplings and wire ends
GP0	Smooth motor shaft Electrical connections via PG couplings and wire ends
G60	Smooth motor shaft Degree of protection IP 65
PU0	Electrical connections via PG couplings and wire ends Unpainted motor
PS0	Smooth motor shaft Electrical connections via PG couplings and wire ends Unpainted motor
VA0	Smooth motor shaft Holding brake, 24V DC Electrical connections via PG couplings and wire ends
P60	Degree of protection IP 65 Electrical connections via PG couplings and wire ends
B60	Holding brake, 24V DC Degree of protection IP 65
F60	Degree of protection IP 65 Flange receptacle located on the B-side
VI0	Smooth motor shaft Holding brake, 24V DC Absolute or incremental encoder - preparation for attachment
GI0	Smooth motor shaft Absolute or incremental encoder - preparation for attachment
V60	Smooth motor shaft Holding brake, 24V DC Degree of protection IP 65
L60	Smooth motor shaft Degree of protection IP 65 Electrical connections via PG couplings and wire ends
BL0	Holding brake, 24V DC Degree of protection IP 65 Electrical connections via PG couplings and wire ends

1.5.2 Special

Code	Options
GWS	Smooth motor shaft Custom diameter shaft
2P0	2 feather keys on motor shaft
6P0	Degree of protection IP 65 2 feather keys on motor shaft
MS0	Custom mechanical design
SL0	Custom paint finish
GK0	Smooth motor shaft Short motor shaft
R60	Degree of protection IP 65 Rust proofed shaft
F60	Degree of protection IP 65 Flange receptacle located on the B-side
B40	Holding brake, 24V DC Flange B 14
VR0	Smooth motor shaft Degree of protection IP 65 Absolute or incremental encoder - preparation for attachment Electrical connections via PG couplings and wire ends Rust proofed shaft
S60	Degree of protection IP 65 Electrical connections via PG couplings and wire ends 2 feather keys on motor shaft Rust proofed shaft
GZ0	Smooth motor shaft With center hole
N60	Smooth motor shaft Degree of protection IP 65 With special rotation speed utilizing software (6000)
HW0	Smooth motor shaft With hollow shaft
T60	Degree of protection IP 65 Special design for tropical climates
X60	Degree of protection IP 65 Flange receptacle located on the B-side 2 feather keys on motor shaft
TMN	Smooth motor shaft Thermal motor protection NTC Custom diameter shaft

2.1 General Technical Data

Description		AC M2n
Degree of Protection: With Mounted Mating Connectors and Built-on Motor	IP54	●
	IP65	○
Magnetic Material:	Nd Fe Bo	●
Electrical Connections:	Rotatable, angled 90° for motor and resolver flange receptacles	●
	Couplings with wire ends	○
Thermal Protection of the Motor:	Thermo sensor PTC	●
Power:	In accordance with DIN VDE 0530 Installation location: 1000 m ASL, T = 100K, Tu 40 °C measured with attached cooling unit	●
Voltage:	325 V DC	●
	565 V DC	●
	Other windings available upon request.	○
Cooling:	Self-cooling	●
Ambient temperature:	-10 ... +40°C	●
Operating Mode:	Continuous operation S1	●
Bearings:	Ball bearings	●
Noise Level:	<= 90 dB(A) during operation without a load	●
Motor Shaft:	With feather key, in accordance with DIN 6885	●
Rotational Accuracy:	N, , in accordance to DIN ISO 2373	●
Number of pole pairs:	3	●
Resolver Type:	2 pole transmitter resolver	●
Insulation Class:	F (VDE 0530) 155° C, heating 100° K	●
Paint : (standard)	Black (RAL 9005)	●

Standard Design ●
Optional ○

I

2.2 Power Supply 1 x 230VAC / 3 x 230VAC

Servo Motor Type	Size	Static		Rated				Max. Static Torque	Moment of Inertia		
		Torque	Current	Torque	Speed	Current	Power		Without Brake	With Brake	
-	-	M_0	I_0	M_N	n_N	I_{N310}	P_N	M_{0max}	J_M	J_M	
		[Nm]	[A]	[Nm]	[min ⁻¹]	[A]	[kW]	[Nm]	[kgcm ²]	[kgcm ²]	
AC M2n0012-6/Y-3	1)	Y	0,16	0,44	0,12	6000	0,33	0,075	0,64	0,05	-
AC M2n0010-4/0-3		0	0,13	0,25	0,10	4000	0,20	0,040	0,52	0,05	0,08
AC M2n0030-4/0-3		0	0,30	0,90	0,30	4000	0,80	0,126	1,20	0,10	0,13
AC M2n0045-4/0-3		0	0,50	1,20	0,45	4000	1,08	0,189	2,00	0,15	0,18
AC M2n0070-4/0-3		0	0,80	1,60	0,70	4000	1,46	0,293	3,20	0,20	0,23
AC M2n0130-4/0-3	1)	0	1,50	3,30	1,30	4000	2,80	0,545	6,00	0,33	-
AC M2n0055-4/1-3		1	0,80	2,10	0,55	4000	1,40	0,230	3,20	0,30	0,60
AC M2n0090-4/1-3		1	1,50	3,00	0,90	4000	1,80	0,377	6,00	0,68	0,98
AC M2n0150-4/1-3		1	2,50	5,00	1,50	4000	3,00	0,628	10,00	1,00	1,30
AC M2n0220-4/1-3		1	3,00	6,40	2,20	4000	4,70	0,922	12,00	1,40	1,70
AC M2n0290-4/1-3		1	4,00	8,30	2,90	4000	6,00	1,215	16,00	1,80	2,10
AC M2n0320-4/2-3		2	4,00	8,20	3,20	4000	6,40	1,340	16,00	2,45	3,08
AC M2n0480-4/2-3		2	7,00	14,30	4,80	4000	9,80	2,010	28,00	3,24	3,87
AC M2n0650-4/2-3		2	9,00	18,30	6,50	4000	13,20	2,720	36,00	3,78	4,41

1) Not available with a holding brake

Servo Motor Type	Size	Weight	Motor		Thermal Time Constant		Torque Constant	EMF Constant eff.	
			Resistance	Induction	with I_N	with I_{max}			
-	-	m	Rph/ph	Lph/ph	T_{thN}	T_{thmax}	KT	KE	
		[kg]	[Ω]	[mH]	[min]	[s]	[Nm/A]	[V/1000 min ⁻¹]	
AC M2n0012-6/Y-3	1)	Y	1,01	35,00	22,00	11	28	0,38	23,0
AC M2n0010-4/0-3		0	0,83	122,00	66,00	7	18	0,50	30,0
AC M2n0030-4/0-3		0	1,30	18,30	13,00	10	26	0,40	26,0
AC M2n0045-4/0-3		0	1,60	12,00	14,30	12	31	0,41	28,0
AC M2n0070-4/0-3		0	1,90	8,90	9,30	14	36	0,50	28,0
AC M2n0130-4/0-3	1)	0	2,80	3,80	4,60	14	36	0,46	28,0
AC M2n0055-4/1-3		1	2,00	6,30	14,30	20	51	0,39	26,0
AC M2n0090-4/1-3		1	2,90	3,10	9,20	20	51	0,50	30,0
AC M2n0150-4/1-3		1	3,70	1,70	6,00	23	59	0,50	30,0
AC M2n0220-4/1-3		1	4,30	1,10	4,30	26	66	0,50	33,5
AC M2n0290-4/1-3		1	5,30	0,80	3,20	30	77	0,48	33,0
AC M2n0320-4/2-3		2	6,00	1,00	5,50	19	49	0,49	35,0
AC M2n0480-4/2-3		2	7,60	0,40	2,30	29	74	0,49	30,0
AC M2n0650-4/2-3		2	8,50	0,47	1,90	38	97	0,49	33,0

1) Not available with a holding brake

$KT \approx KT_0 \approx KT_N$

Data at rated speed

2.3 Power Supply 1 x 400VAC

Servo Motor Type	Size	Static-		Rated-				Max. Static Torque	Moment of Inertia	
		Torque	Current	Torque	Speed	Current	Power		without Brake	with Brake
-	-	M ₀	I ₀	M _N	n _N	I _{N310}	P _N	M _{0max}	J _M	J _M
		[Nm]	[A]	[Nm]	[min ⁻¹]	[A]	[kW]	[Nm]	[kgcm ²]	[kgcm ²]
AC M2n0045-4/0-6		0,50	0,65	0,45	4000	0,60	0,189	2,00	0,15	0,18
AC M2n0070-4/0-6		0,80	0,90	0,70	4000	0,82	0,293	3,20	0,20	0,23
AC M2n0130-4/0-6	1)	1,50	1,65	1,30	4000	1,40	0,545	6,00	0,33	-
AC M2n0055-4/1-6		0,80	1,20	0,55	4000	0,76	0,230	3,20	0,30	0,60
AC M2n0090-4/1-6		1,50	1,80	0,90	4000	1,10	0,377	6,00	0,68	0,98
AC M2n0150-4/1-6		2,50	2,70	1,50	4000	1,90	0,628	10,00	1,00	1,30
AC M2n0220-4/1-6		3,00	3,80	2,20	4000	2,80	0,922	12,00	1,40	1,70
AC M2n0290-4/1-6		4,00	4,20	2,90	4000	3,00	1,215	16,00	1,80	2,10
AC M2n0320-4/2-6		4,00	4,50	3,20	4000	3,60	1,340	16,00	2,45	3,08
AC M2n0480-4/2-6		7,00	7,20	4,80	4000	4,90	2,010	28,00	3,24	3,87
AC M2n0650-4/2-6		9,00	9,20	6,50	4000	6,60	2,720	36,00	3,78	4,41
AC M2n0830-4/2-6		11,00	12,30	8,30	4000	9,30	3,480	44,00	5,12	5,75
AC M2n0960-4/2-6		16,00	18,40	9,60	4000	11,00	4,020	64,00	6,15	9,28
AC M2n1200-4/2-6		21,00	28,00	12,00	4000	16,00	5,030	84,00	7,70	10,83
AC M2n2000-4/2-6		34,00	33,00	20,00	4000	19,30	8,370	136,00	12,53	15,66

1) Not available with a holding brake

Servo Motor Type	Size	Weight	Motor-		Thermal Time Constant		Torque Constant	EMF Constant eff.
			Resistance	Induction	with I _N	with I _{max}		
-	-	m	Rph/ph	Lph/ph	Tth _N	Tth _{max}	KT	KE
		[kg]	[Ω]	[mH]	[min]	[s]	[Nm/A]	[V/1000 min ⁻¹]
AC M2n0045-4/0-6		1,60	32,00	28,00	12	31	0,74	47,00
AC M2n0070-4/0-6		1,90	27,70	23,00	14	36	0,83	50,00
AC M2n0130-4/0-6	1)	2,80	13,70	13,90	14	36	0,92	51,00
AC M2n0055-4/1-6		2,00	18,40	39,00	20	51	0,66	44,00
AC M2n0090-4/1-6		2,90	7,70	24,00	20	51	0,83	50,00
AC M2n0150-4/1-6		3,70	5,20	16,70	23	59	0,94	59,00
AC M2n0220-4/1-6		4,30	2,80	11,00	26	66	0,83	52,00
AC M2n0290-4/1-6		5,30	2,40	9,30	30	77	0,97	55,00
AC M2n0320-4/2-6		6,00	2,80	13,60	19	49	0,98	60,00
AC M2n0480-4/2-6		7,60	2,00	11,30	29	74	0,98	68,00
AC M2n0650-4/2-6		8,50	1,30	7,60	38	97	0,98	60,00
AC M2n0830-4/2-6		16,00	0,80	4,70	50	128	0,89	54,00
AC M2n0960-4/2-6		19,50	0,60	6,10	36	92	0,87	58,00
AC M2n1200-4/2-6		22,00	0,30	3,20	52	133	0,75	48,00
AC M2n2000-4/2-6		30,00	0,30	3,80	88	225	1,04	65,00

1) Not available with a holding brake

$$KT \approx KT_0 \approx KT_N$$

Data at rated speed



2.4 Torque/Speed Diagrams

2.4.1 Motor Size Y and 0

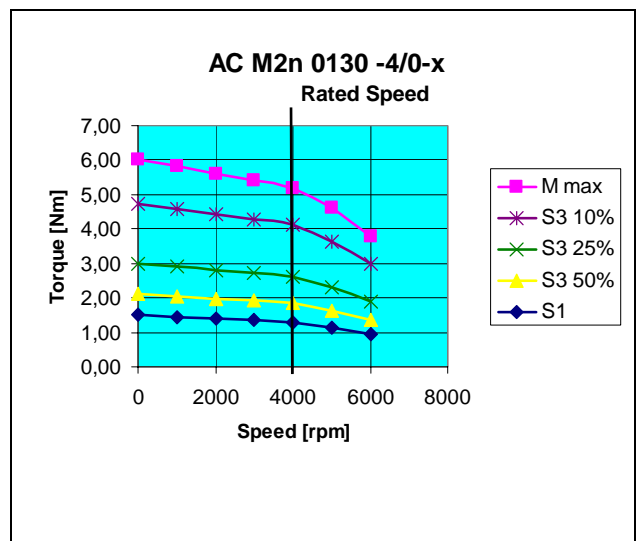
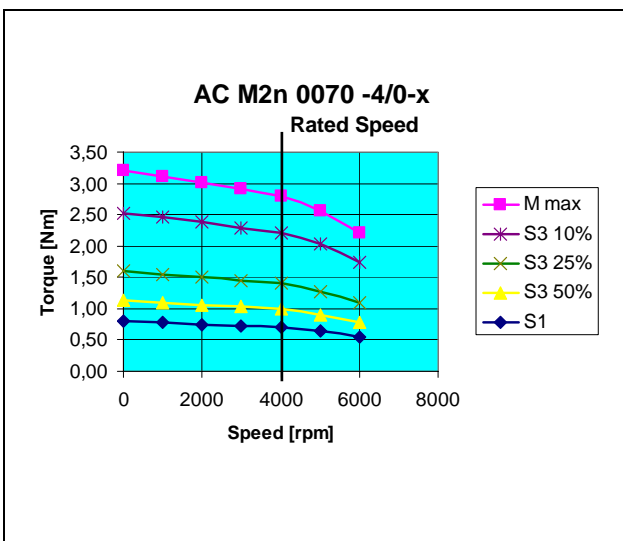
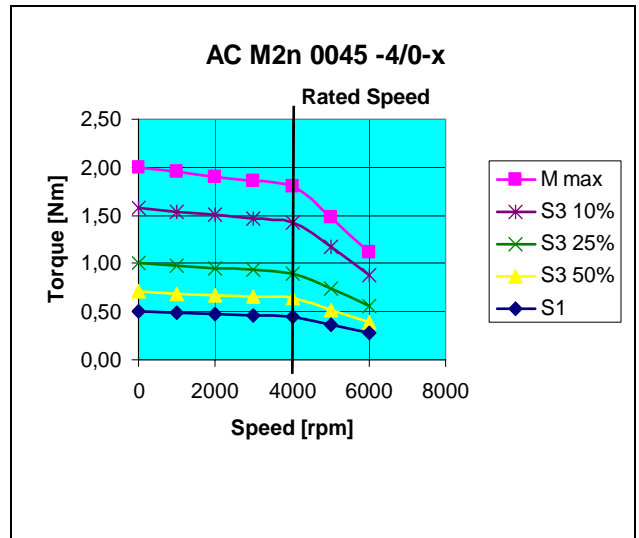
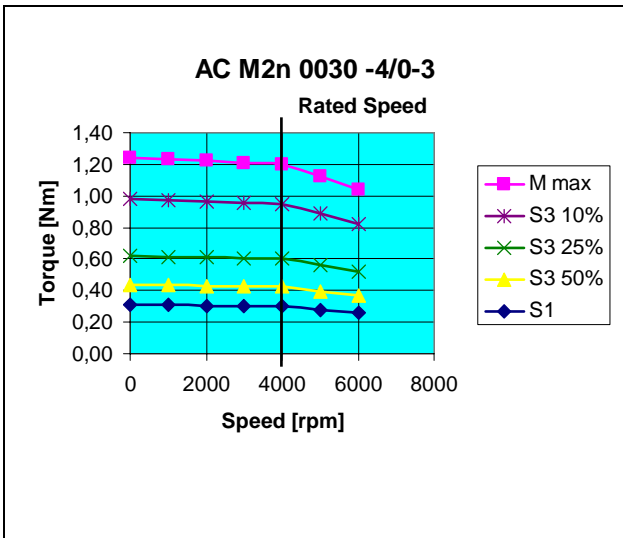
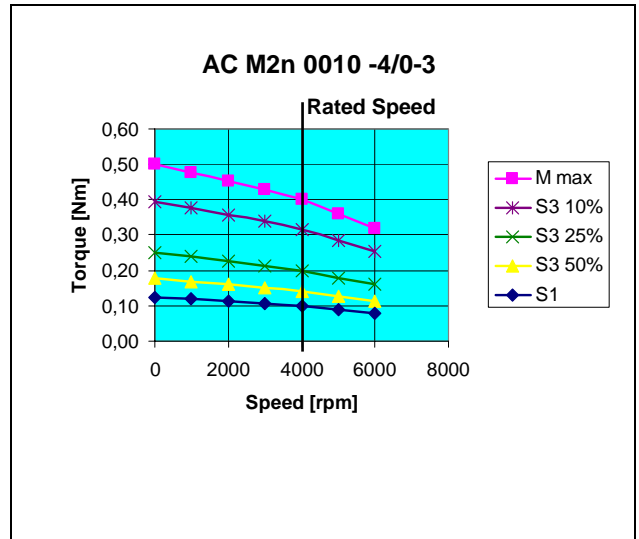
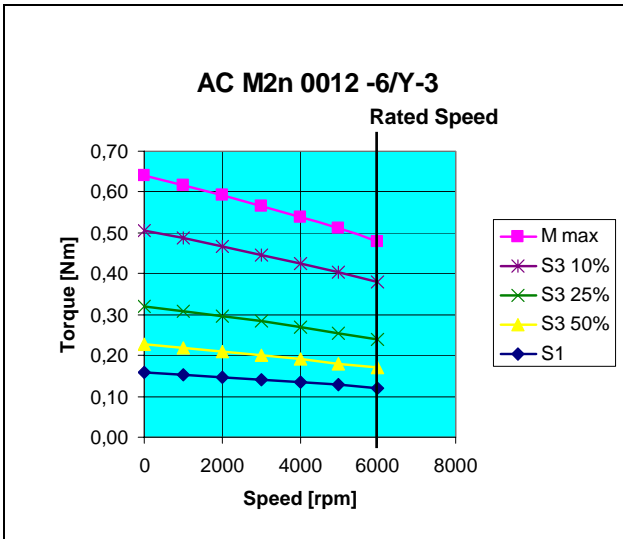

2.4.2 Motor Size 1

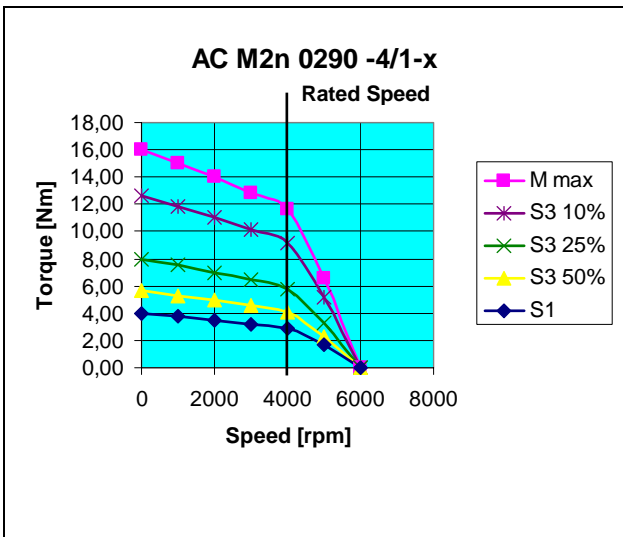
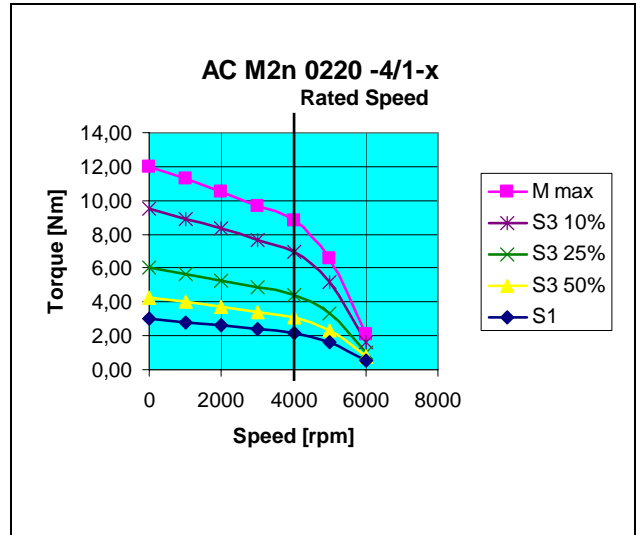
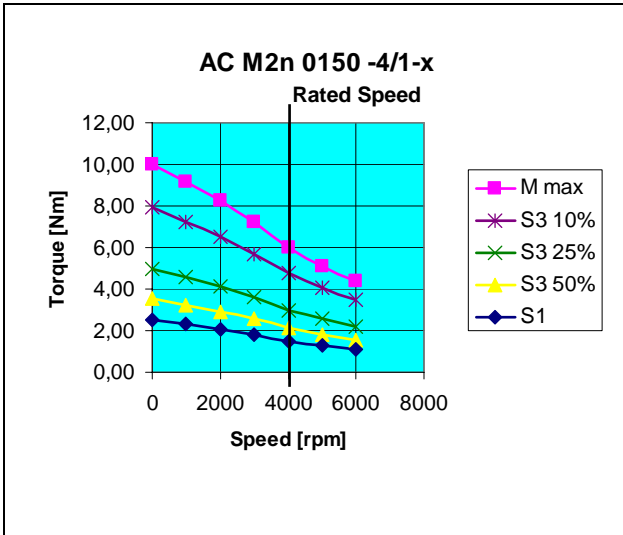
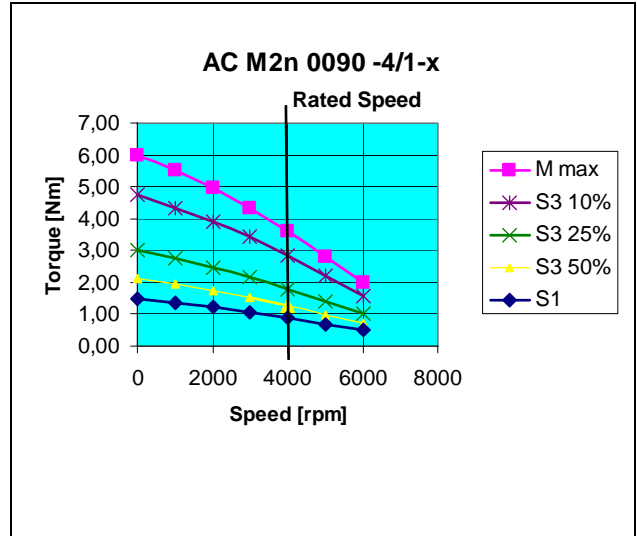
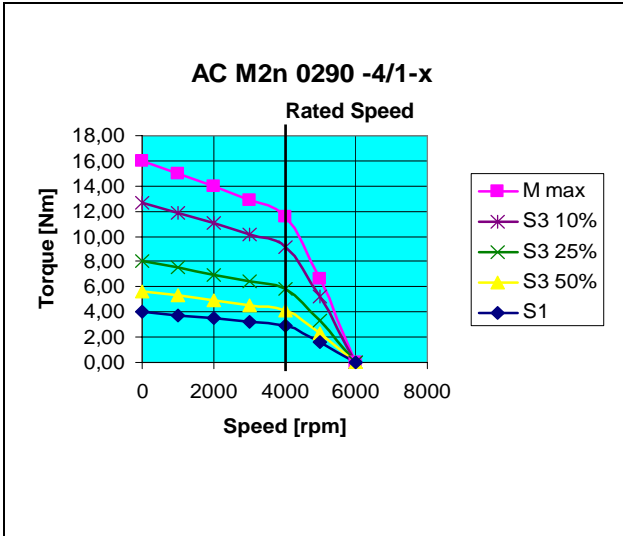



2.4.3 Motor Size 2

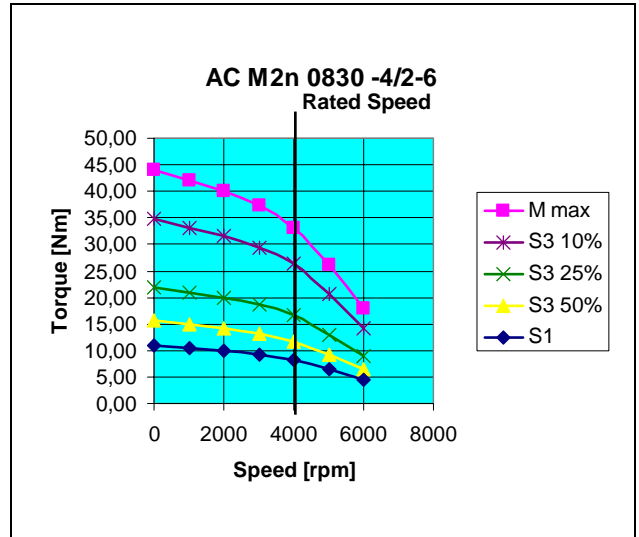
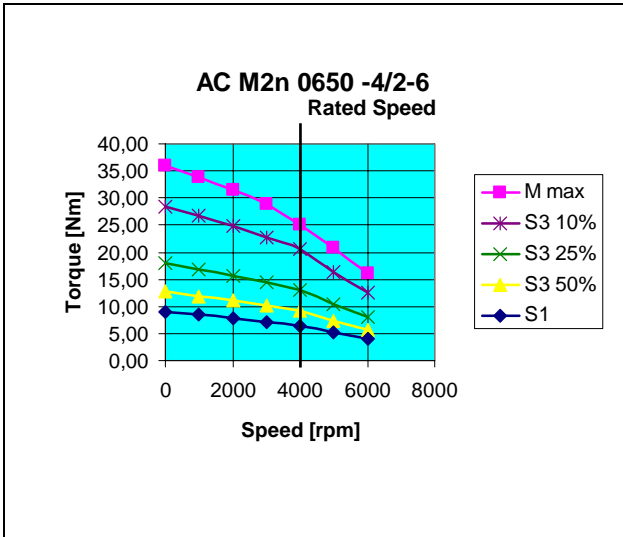
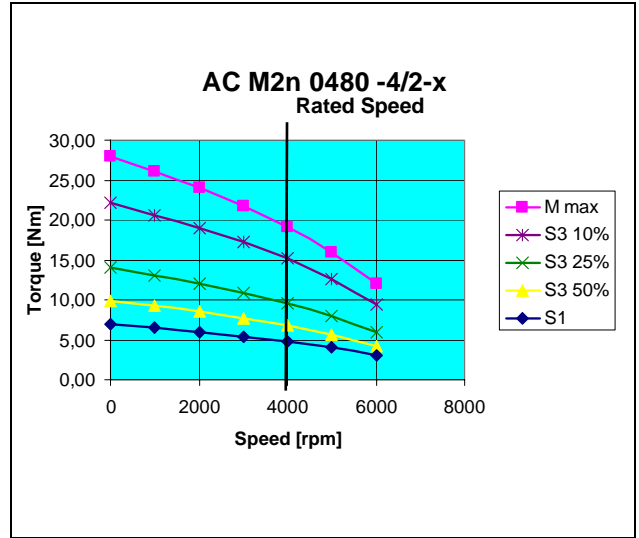
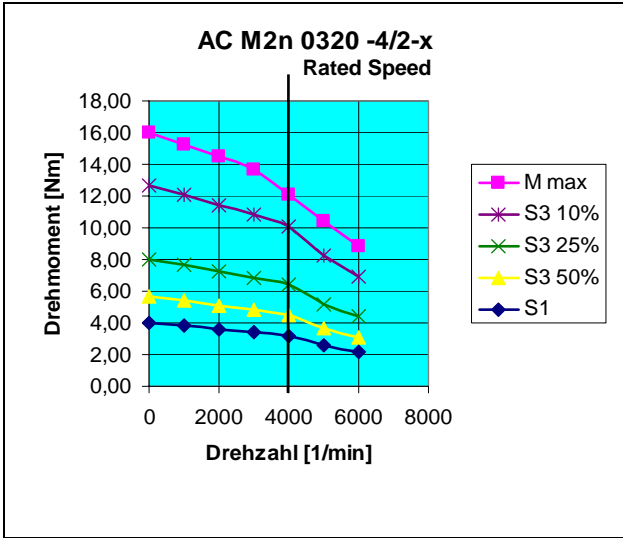

2.4.4 Motor Size 3

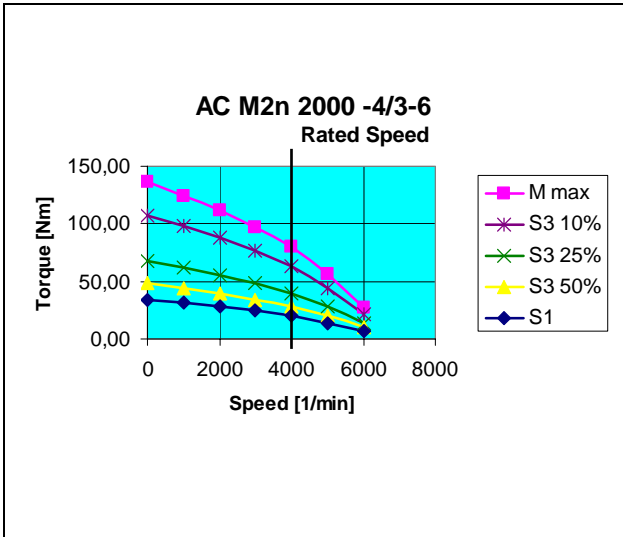
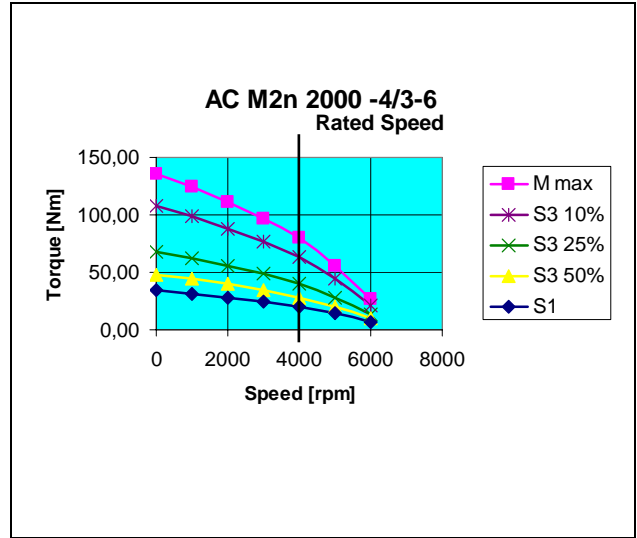
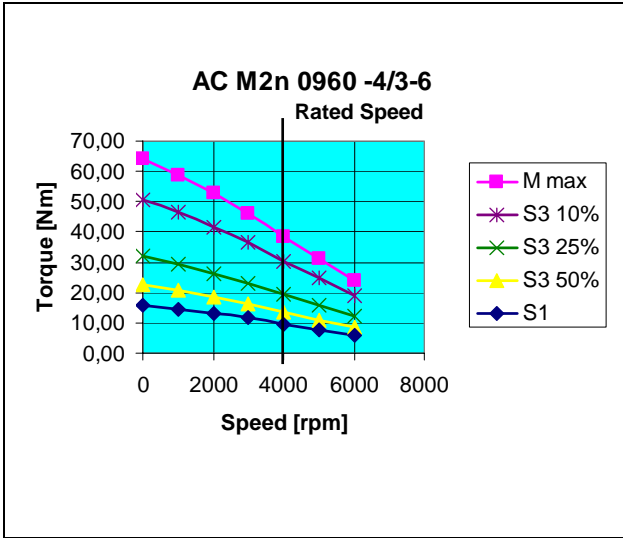

3

Dimensions

3.1 Connections with Cables and PG - Gland, Motor Size Y

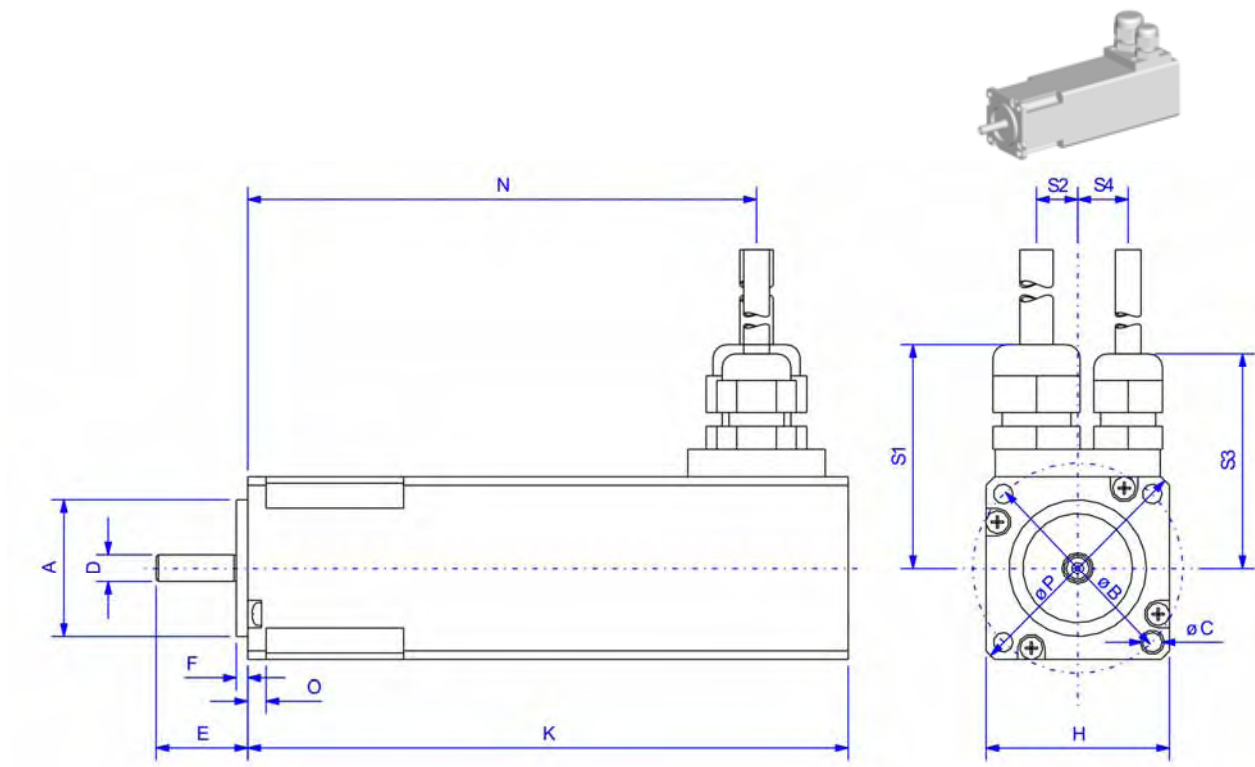

Type	BG	A j6	B	C	D k6	E	F	H □	K	N	O	P	S1	S2	S3	S4
AC M2n0012... ¹⁾	Y	30	46	4,3	6	20	2,5	40	131	111	4	54	49	9	11	47

¹⁾ Not available with holding brake or feather key shaft.
All dimensions in "mm".

Connection Layout:

Power Connection	Function	Colour Coding	Core Cross-Section	Minimal Bend Radius
	M1 (U)	black 1	(4x1,5 mm ²)+S	fixed wiring 80 mm
	M2 (V)	black 2		
	M3 (W)	black 3		
	Ground	yellow/green		
	Screen	-		bending fatigue strength 127 mm

Resolver Connection	Function	Colour Coding	Core Cross-Section	Minimal Bend Radius
	Carrier +	grey	(3x(2x0,14 mm ²)+S+ (2x014 mm ²))+S	fixed wiring 54mm
	Carrier -	pink		
	Cos +	green		
	Cos -	yellow		
	Sin +	yellow		
	Sin -	blue		
	PTC	red		
	PTC	blue		
Screen	-	bending fatigue strength 86 mm		

Standard Cable Length = 5m

3.2 Connections with Plug - Design, Motor Size 0 - 3

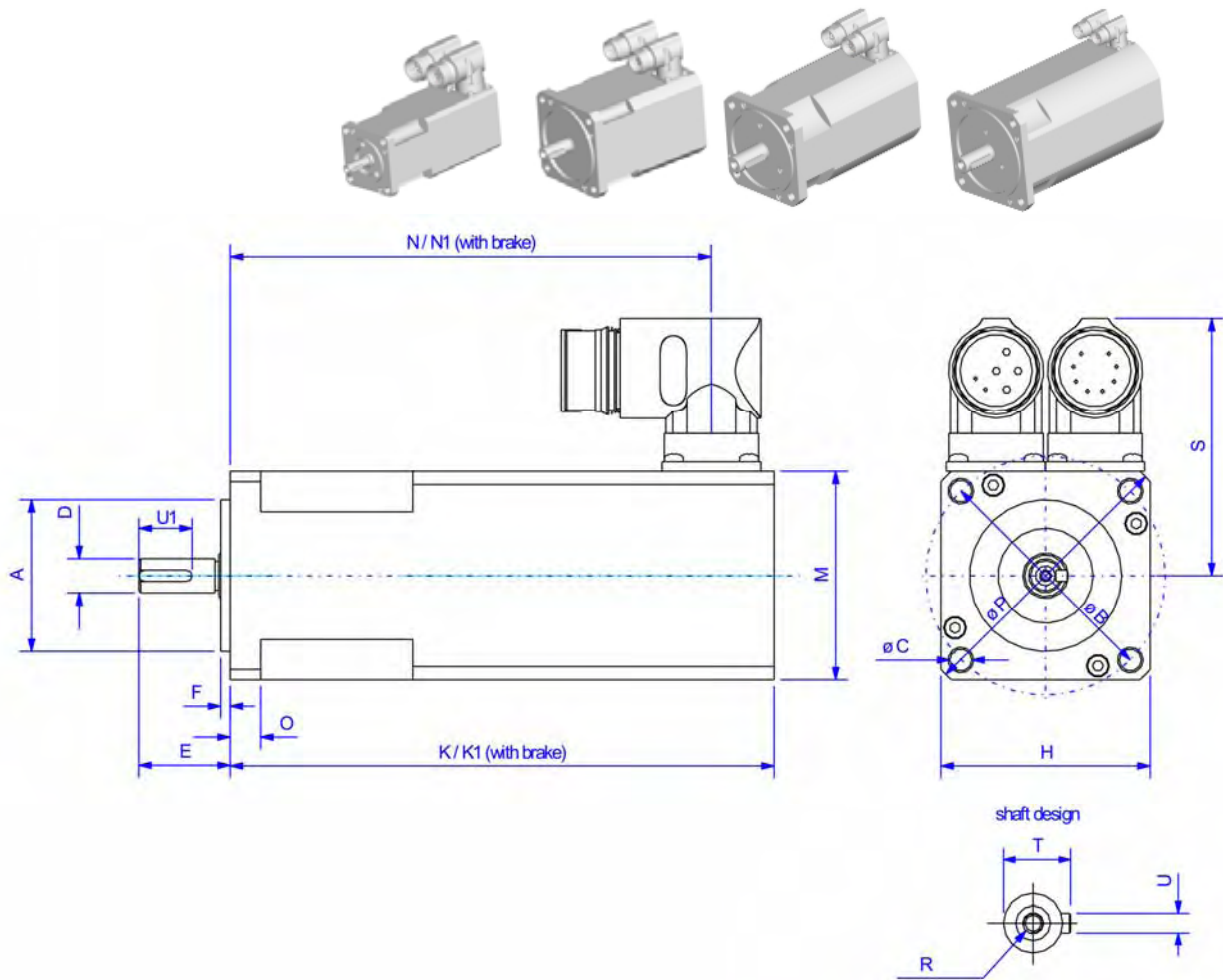

Type	BG	A j6	B	C	D k6	E	F	H	K	K1	M	N	N1	O	P	R	S	T	U h9	U1
ACM2n0010..	0	40	63	5,8	9	24	2,5	55	98	131	55	81,5	114,5	8	74	M3x10	67,7	10,2	3	14
ACM2n0030.	0	40	63	5,8	9	24	2,5	55	123	156	55	106,5	139,5	8	74	M3x10	67,7	10,2	3	14
ACM2n0045..	0	40	63	5,8	9	24	2,5	55	143	176	55	126,5	159,5	8	74	M3x10	67,7	10,2	3	14
ACM2n0070..	0	40	63	5,8	9	24	2,5	55	163	196	55	146,5	179,5	8	74	M3x10	67,7	10,2	3	14
ACM2n0130..	0	40	63	5,8	9	24	2,5	55	234	-	55	216,5	-	8	74	M3x10	67,7	10,2	3	14
ACM2n0055..	1	80	100	7,0	14	30	3,0	88	112	153	82	91,0	131,0	10	115	M4x12	81,2	16,0	5	20
ACM2n0090..	1	80	100	7,0	14	30	3,0	88	132	173	82	111,0	151,0	10	115	M4x12	81,2	16,0	5	20
ACM2n0150..	1	80	100	7,0	14	30	3,0	88	152	193	82	131,0	171,0	10	115	M4x12	81,2	16,0	5	20
ACM2n0220..	1	80	100	7,0	14	30	3,0	88	172	213	82	151,0	191,0	10	115	M4x12	81,2	16,0	5	20
ACM2n0290..	1	80	100	7,0	14	30	3,0	88	202	249	82	181,0	228,0	10	115	M4x12	81,2	16,0	5	20
ACM2n0320..	2	95	115	9,0	19	40	3,0	105	178	218	105	158,0	198,0	12	134	M6x15	92,7	21,5	6	30
ACM2n0480..	2	95	115	9,0	19	40	3,0	105	208	248	105	188,0	228,0	12	134	M6x15	92,7	21,5	6	30
ACM2n0650..	2	95	115	9,0	19	40	3,0	105	228	268	105	208,0	248,0	12	134	M6x15	92,7	21,5	6	30
ACM2n0830.. ¹⁾	2	95	115	9,0	19	40	3,0	105	273	313	105	258,0	298,0	12	134	M6x15	92,7	21,5	6	30
ACM2n0960..	3	130	165	11,0	24	50	3,5	145	260	303	145	240,0	283,0	12	188	M8x25	112,7	27,0	8	40
ACM2n1200..	3	130	165	11,0	24	50	3,5	145	300	343	145	280,0	323,0	12	188	M8x25	112,7	27,0	8	40
ACM2n2000..	3	130	165	11,0	24	50	3,5	145	420	463	145	400,0	443,0	12	188	M8x25	112,7	27,0	8	40

¹⁾ K1 with 6Nm holding brake

All dimensions in "mm"

Important !

- Please pay attention to the bending radius limitations of the cable.
See: Cable documentation 12-02-01!

4.1 Terminal Connections for Motor Sizes BG 0 - 2

Power connector

motor side

SSD Drives - motor size 0...2

Model: AC G, AC M2n; ACM2G; AC M2K
AC MHS / MHM

regulator side

SSD Drives - Servo drives

Model: 631/635 and 637/637+/637f
637+/637f
in the compact enclosure

view solder / crimp connector - side

S MB GM2nRn BG 0/3-C+L ST.0100.3001		K MB BG 0/2-B KA.0003.6304		terminal strip	
PIN - Nr.		colour	function	PIN - Nr.	
1		black 1	motor connection	M1	
2		¹⁾ yellow/green	ground connection	PE	
3		black 2	motor connection	M2	
4		black 3	motor connection	M3	
A		red	brake +24V DC ²⁾	Connection	
B		blue	brake 0V DC ²⁾	not on terminal	
C		-	-	-	
D		-	-	-	
case		¹⁾	screen	case	

¹⁾ motor mating plug the screen is connected to the groundpin and also extensively to the case.

²⁾ **Attention ! Security and insulation:**
The brake must be insulated for secure division (PELV). Otherwise, the insulation class of the drive becomes reduced or the effort of an additional galvanic separation is required.

				Maßstab / scale:	
				Typ / model: KK MB GM2nRn 0/2.K - XX.X / B	
				Bezeichnung / designation: Blue motor cable (compact enclosure) for SSD Drives standard motors and servo drives	
				Zeichnungsnummer / drawing No: Z-MK.6400.xxxx	
				Blatt sheet 1	
Zust: Änderung Datum Name Ursprung				Dateiname / File name: Z-MK-6400-E.cdr	

4.1.1 Terminal Connections for Motor Size BG 3

motor side

SSD Drives - motor size 3

Model: AC M2n
AC MHS / MHM
AC MRW

regulator side

SSD Drives - Servo drives

Model: 631/635 and 637/637+/637f
637+/637f
in the compact enclosure

view solder / crimp connector - side

S MB GM2nRn BG 0/3-C+L ST.0100.3001		K MB BG 3-B KA.0003.6302		terminal strip	
PIN - Nr.		colour	function		PIN - Nr.
1		black 1	motor connection		M1
2	¹⁾	yellow/green	ground connection		PE
3		black 2	motor connection		M2
4		black 3	motor connection		M3
A		red	brake +24V DC	²⁾	Connection
B		blue	brake 0V DC	²⁾	not on terminal
C		-	-		-
D		-	-		-
case	¹⁾		screen		case

¹⁾ motor mating plug
the screen is connected to the groundpin and also extensively to the case.

²⁾ **Attention ! Security and insulation:**
The brake must be insulated for secure division (PELV). Otherwise, the insulation class of the drive becomes reduced or the effort of an additional galvanic separation is required.

Caution ! at X50 connector a terminal block must be employed

				Maßstab / scale:	
				Typ / model: KK MB M2nRn 3	
Bear.		06.02.02	DL		Bezeichnung / designation: Blue motor cable for SSD Drives AC M2n size 3 motors and servo drives
Gep.		14.02.02	EH		
Norm					
				Zeichnungsnummer / drawing No: Z-MK.6401.xxxx	
				Blatt sheet 1	
01	637f	16.04.03	DL		
Zust.	Änderung	Datum	Name	Ursprung	Dateiname / File name: Z-MK.6401-E.cdr

4.2 X50 – Terminal Connections for Motor Sizes BG 0 - 2

X50 - connector

motor side

SSD Drives - motor size 0...2

Model: AC M2n; ACM2G; AC M2K
AC MHS / MHM

regulator side

SSD Drives - servo drives

Model: 635 and 637/637+/637f
637+/637f
in the Rack

view solder / crimp connector - side

S MB GM2nRn BG 0/3-C+L ST.0100.3001	K MB BG 0/2-B KA.0003.6304		X50 connector strip	³⁾
PIN - Nr.	colour	function	PIN - Nr.	
1	black 1	motor connection	10	
2	¹⁾ yellow/green	ground connection	12	
3	black 2	motor connection	14	
4	black 3	motor connection	16	
			18	
			20	
A	red	brake +24V DC	-	²⁾
B	blue	brake 0V DC	-	²⁾
C	-	-	-	
D	-	-	-	
case	¹⁾	screen	case	

¹⁾ motor mating plug the screen is connected to the groundpin and also extensively to the case.

⚠ Attention ! Security and insulation:
The brake must be insulated for secure division (PELV). Otherwise, the insulation class of the drive becomes reduced or the effort of an additional galvanic separation is required.

³⁾ not in the Scope of delivery

				Maßstab / scale:	
				Typ / model: KK MB GM2nRn 0/2.R - XX.X / B	
				Bezeichnung / designation: Blue motor cable (plugs/terminal strip) for SSD Drives standard motors and servo drives	
				Zeichnungsnummer / drawing No: Z-MK.0400.xxxx	
				Blatt sheet 1	
Zust.	Änderung	Datum	Name	Ursprung	Dateiname / File name: Z-MK-0400-E.cdr

4.3 Resolver Connection

motor side

SSD Drives - motor size 0...4

Type: AC G, AC R, AC M_n,
AC M_{2n}, AC M_{2K}; ACM_{2G}
AC MRW, AC MRL

view solderside

regulator side

SSD Drives - servo drives

Model: 631/635 and 637/637+/637f

view solderside

SIR ST.0200.0001	KIR -B KA.0003.6301		SUB - D 09 S/M ST.1002.2001
PIN - Nr.	colour	function	PIN - Nr.
1	white	sin +	4
2	brown	sin -	8
3	green	cos +	3
4	yellow	cos -	7
5	red	PTC optional	2
6	blue	PTC optional	6
7	pink	carrier -	9
8	gray	carrier +	5
case		screen	case

								Maßstab / scale:	
								Typ / model:	
								KK RT GMR-xx.x/B	
								Bezeichnung / designation:	
								Blue resolver cable for SSD Drives standard motors and servo drives	
								Zeichnungsnummer / drawing No:	
								Z-RK.6300.xxxx	
								Blatt sheet 1	
Zust.	Änderung	Datum	Name	Ursprung	Dateiname / File name: Z-R.6300-E.cdr				

4.4 Wiring Instructions

Important rules when operating servo drives and servo motors:

Before any connections are made, it is necessary to make certain that the power to cabinet is off. It is necessary to explicitly follow the connection directions as outlined in the product documentation and to employ the prescribed type and quality of cable that is recommended there.

1. A radio interference suppression level cannot be maintained without an interference suppression filter at the line input. Moreover, line filters increase the immunity of the system to interference.
2. The cable between the power electronics and the motor must be shielded as YCY. A SY shield is not suitable. The shield support for the power cable (motor cable) must be on both ends. We recommend using Eurotherm motor cables!
3. Metal parts in the switching cabinet must be connected with each other having large areas of contact and must carry high frequencies very well. Avoid anodized, yellow-passivating and painted surfaces which can have very high resistance values based on the frequency! Make sure that the metals lie close together in the chemical electromotive series! Use the good conductivity and the large surface of the galvanized mounting plate as earth potential!
4. Relays, contactors and solenoid valves built into the same circuit must be connected with spark-suppressing components limiting over voltage spikes. This applies also if these parts are not mounted in the same cabinet as the servo regulator.
5. The shield for the analog signal lines must be installed on one end and, if possible, in the switching cabinet. Ensure a connection which provides extensive contact and which is low - resistant! The shield for the digital signal lines must be installed on both ends, must have extensive contact and must be low resistance. An additional equalizer is to be laid parallel when there are potential differences. It is necessary to use plugs with metal enclosures with separable connections.
6. Avoid unnecessary extra loops on all connecting cables. All measures regarding filtering and shielding can be short circuited on them with high frequency. Connect unused wires in cables on both ends to the equipment ground conductor.
7. Unshielded cables of a circuit, the conductors going out and returning, should be twisted due to symmetrical interferences.
8. Separate physically "live" and "dead" wires even in the planning phase. Give special attention to the motor cables. The area of the common terminal strip-line input and motor output is especially endangered.
9. Relays, contactors and solenoid valves. The cables should be laid in the switching cabinet as close as possible to the ground; wires hanging freely in the air are preferred EMC victims as well as active and passive aerials.
10. When operating with more than one line component in a common network, EMC problems are to be expected. From the start, the installation planner must integrate in his concept high frequency emitted interference as well as the electromagnetic susceptibility of the components to one another and take measures against it.
11. It is absolutely necessary to run cable shields completely up to the connectors. The connection of the cable shields to ground must be near the servo regulator (10 - 50 cm). Sensitive measuring leads should be as far as possible from this area; this applies also when they are shielded!
12. It is mandatory to run the motor cables in a separate cable channel and to lay flexible cable shielding also when these are shielded. This channel must be separated at least 30 - 40 cm from the channel for the signal lines.

4.5 Plug Designations

4.5.1 Mating connector for Motor and Brake Connections

Size		Plug Description	Itm - Number
Y		PG gland with cable	-
0 ... 3		S MB GM2n Rn BG0/3-C	ST.0100.3001

4.5.2 Mating connector for Resolver and Thermal Connections

Size		Plug Description	Itm - Number
Y		PG gland with cable	-
0 ... 3		SIR	ST.0200.0001

4.6 Cable Designations

4.6.1 Motor Cable

Size		Cable Description	Itm - Number
Y ... 2	1)	K MB R BG0/2 - B	KA.0003.6304
		K MB R BG 0/2 - B - LC	KA.0003.6304
3		K MB R BG3 -B	KA.0003.6302

4.6.2 Resolver Cable

Size		Cable Description	Itm - Number
Y ... 3	1)	KIR - B	KA.0001.6301
		KIR - LC	KA.0001.6310

¹⁾ LC = low cost cable

5.1 Technical Data of the Holding Brake

Holding Brake		Motor	Holding Torque	Max. Current	Moment of Inertia	Weight
Type:		Size	M_{BrH} (20° C)	I_{max}	J_{Br}	m_{Br}
		[-]	[Nm]	[A]	[kg cm ²]	[kg]
BR M BG Y	¹⁾	Y	-	-	-	-
BR M BG 0	¹⁾	0	0,75	0,33	0,030	0,190
BR M BG 1		1	3,20	0,42	0,300	0,445
BR M BG 2		2	6,00	0,55	0,630	0,700
BR M BG 3		3	20,00	0,80	3,130	1,040

¹⁾ Motors AC M2n0012 and AC M2n0130 are not available with a holding brake!

Holding brakes are integrated on the A - side; therefore the motor length is changed, see dimension K1 !

Closed-Circuit Current – Holding Brake

- Supply Voltage: 24 VDC +/-10%
- Static Application: blocks the motor shaft at standstill
- Dynamic Application: only in an emergency stop situation. In this situation, the brake has approximately half of the holding torque capacity as when the motor is idle. The number of such braking events is limited.

The inserted brake is not designed for the purpose of slowing down the motor, but is designed to serve as merely a standstill and/or holding brake.

Therefore, the operator must be certain that the motor is not moving before the brake is engaged. Should the brake not be employed as directed, then the holding torque capacity of the brake will be affected, depending upon a number of variables, including but not limited to the following:

- the speed of the drive when the brake is engaged
- the load moment of inertia on the driver
- environmental conditions, such as temperature, humidity, etc.
- the number of times that the brake is engaged and so forth

6.1 Representation of the Definition

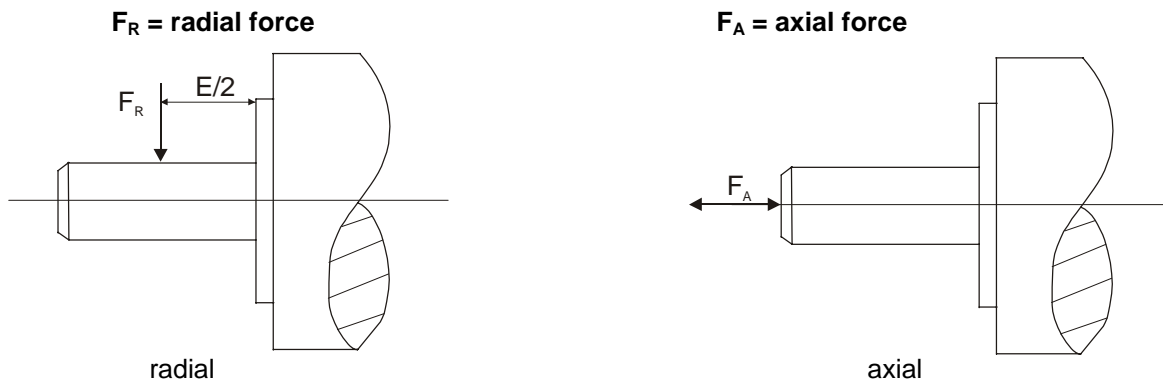

6.2 Technical Data of the Maximum Radial F_R (N) und Axial F_A (N) Shaft Loads (Rated Speed)

Motor Type	Rated Speed	Maximum Radial Shaft Load	Maximum Axial Shaft Load
(-)	n_N (min ⁻¹)	F_R (N)	F_A (N)
AC M2n 0012	6000	51	72
AC M2n 0010	4000	220 (138)	80 (33)
AC M2n 0030	4000	220 (155)	80 (33)
AC M2n 0045	4000	220 (163)	80 (33)
AC M2n 0070	4000	220 (169)	80 (33)
AC M2n 0130	4000	220 (175)	80 (33)
AC M2n 0055	4000	250 (156)	90 (45)
AC M2n 0090	4000	250 (171)	90 (45)
AC M2n 0150	4000	250 (181)	90 (45)
AC M2n 0220	4000	250 (189)	90 (45)
AC M2n 0290	4000	250 (195)	90 (45)
AC M2n 0320	4000	300 (333)	100 (71)
AC M2n 0480	4000	300 (346)	100 (71)
AC M2n 0650	4000	300 (362)	100 (71)
AC M2n 0830	4000	300 (391)	100 (71)
AC M2n 0960	4000	570 (383)	200 (83)
AC M2n 1200	4000	570 (398)	200 (83)
AC M2n 2000	4000	570 (427)	200 (83)

() The values in brackets relate to the simultaneous radial and axial shaft loads.
The specifications refer to 20,000 hours of operation.

6.3 Ball Bearing Types Employed

MotorSize	Ball Bearing Types	
	A-side	B-side
Y	607	607
0	6001	6001
1	6003	6001
2	6004	6002
3	6205	6004

7.1 Nominal Power – Dependence upon the Installation Altitude of the Servo Motor

When selecting an appropriately sized motor, the following needs to be considered:

Workload (power), operating mode, starting, braking and by-pass processes, additional moment of inertia and additional characteristics of the equipment installation, including speed control if necessary, net ratios, coolant temperature, installation altitude etc.

The nominal power is the power that is mechanically available at the drive shaft, if the installation site is not located above 1,000 meters above sea level, (MSL), the air temperature does not exceed 40° C, and the net ratios are normal. With differing installation parameters concerning installation altitude and air temperature, the anticipated nominal power availability must be corrected utilizing the following graph:

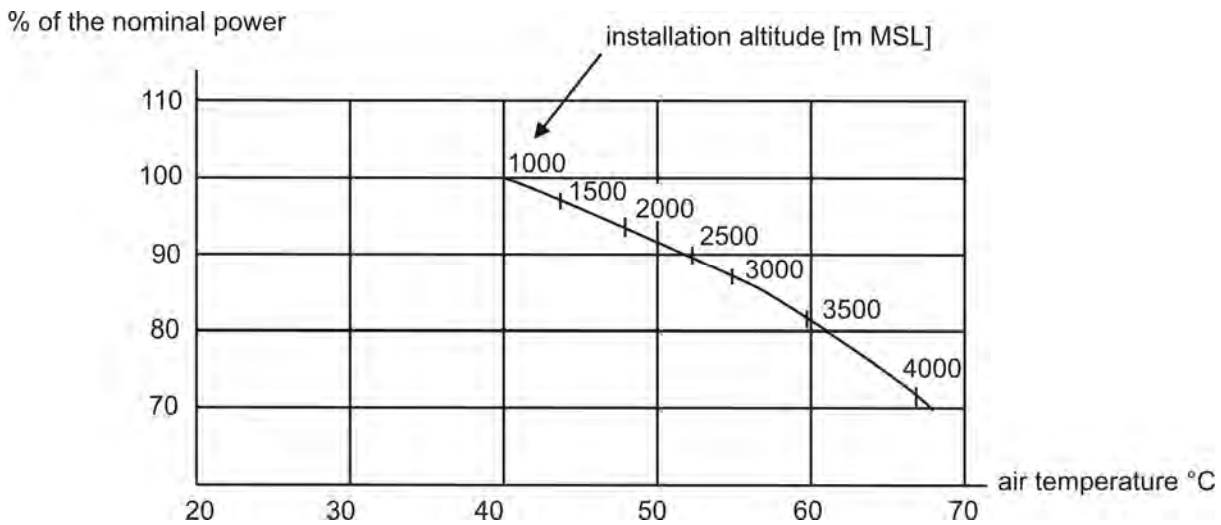

Check the air temperature and the installation altitude separately. Should there be differing air temperatures and installation altitudes concurrently, the factors concerning available nominal power need to be multiplied.

8.1 Security and Safety Instructions

	<p>It is imperative that all relevant legal regulations and the instructions detailed in this document be explicitly followed when undertaking the handling, installation, usage and maintenance of the equipment.</p>
<p>Attention :</p>	<p>Strict adherence to the rules of operation is to be guaranteed by the operator.</p>
	<p>High Touch Voltage ! Electric Shock ! Danger of life !</p>
<p>Danger :</p>	<p>Contact with high voltage electricity can cause death or severe bodily damage.</p>
	<p>Opening of the servo motor case by the operator is not allowed due to safety and product guarantee considerations.</p> <p>Proper professional implementation is required for problem free operation of the servo motor!</p>
<p>Caution :</p>	<p>Possible results of improper implementation or activity include non-life threatening injuries.</p>
	<p>We accept no responsibility or liability for damage which is caused when the legal regulations and/or the product instructions are not explicitly followed.</p>
<p>Stop :</p>	<p>Damage to the servo motor and the area of installation are possible ramifications of non-adherence to the established regulations and instructions.</p>

8.2 Mounting and Installation Instructions

8.2.1 General Preparation

- The installation should be designed to allow for access to the wiring connections and so that it is possible to read the name plate on the equipment.
- The equipment should be installed in a manner which allows for the free flow of air circulation around the unit to facilitate adequate cooling of the equipment.
- Only when the motor is protected from dust and water can the optimal life span and performance of the equipment be assured.
- The outgoing cable connections should be located underneath the unit to eliminate the potential for dust or moisture accumulating in the connection area.
- The motor shaft can be cleaned utilizing a cloth that has been moistened with benzene, alcohol or acetone. It is important however, to make certain that the cleaning fluid does not penetrate the unit housing.



Please note that the motor housing can reach temperatures in excess of 100° Celsius.

8.2.2 Mechanical Installation Preparation

- When installing a servo motors with a feather key check to make certain that the connection components without the feather key are well balanced.
- It is important to insure the proper installation alignment of the servo motor shaft with the shaft of the working machine so that movement, imbalance and excess stress on the shaft are eliminated.
- Avoid bumping the shaft and pressure fit connections as this can cause damage to the rolling-contact bearings. When work needs to be undertaken on the pressure fittings, we recommend securing the equipment to avoid unnecessary incidental movement.
Even when these steps are taken to minimize potential damage, the functional capability of the resolver may be negatively affected.
- Avoid bumping the shaft as this could interfere with the operation and function of the rolling bearings, pressure fittings or the working surface of the shaft.



Not Allowed

8.2.3 Electrical Connections

- Before any electrical connections are made it is important to make certain that all connections to the cabinet are off.
- The connections must be made according to the installation instructions for the servo controller.
- The cables and plugs which are employed must meet or exceed the quality specifications which we have prescribed.
- The cable cross-section employed must be chosen to insure that there is no voltage drop.

8.2.4 Rotational Direction of the Servo Motor

- When the cabling instructions are followed correctly then the anticipated rotations per minute of the servo controller can be achieved, with the rotation following a clock-wise direction, when looking at the shaft as shown.



9.1 Manufacturer's Declaration



Standard Specifications and Certifications Manufacturer's Declaration

In accordance with the EC – Machinery Directive 98/37/EG
approximation of the regulation of the member states for machinery.

The following Products

AC – Servo - motors of series

AC M2n, AC M2K, AC MHx, AC M2G and AC G

in standard design are components to be incorporated into machinery and may not be operated alone. The complete machinery or installation using this equipment may only be put into service when the safety considerations of the Directive 98/37/EG are fully adhered to.

The above mentioned products are in accordance with the relevant clauses from the following standards.

Basic directives:

- EN 60034 / VDE 0530
- IEC 34 – 1,5,6,8,9,14 / IEC 72 / IEC 85
- VDE 0100, VDE 0110, VDE 0530-1
- EC – MASCHINERY DIRECTIVE 98/37/EG
- EC – LOW VOLTAGE DIRECTIVE 73/23/EEC

CE – Label
as standard on the name plate.

Issuer:

SSD Drives GmbH
Im Sand 14
76669 Bad Schönborn

Bad Schönborn, 18.01.2006

Legally binding signature

ppa. Erich Ehlen
Plant Manager

This declaration does not include any assertion of properties. The references for safety and protection (operating instruction) are to observe in every case keep.

Version	Modification	Chapter	Date	Name	Comments
V01.39EHST99	New !		06.10.1999	K.Stadler	
V02.51DL00	New speed diagrams New technical data	2.1 2	22.12.2000	N. Dreilich	
V0301	Separation German / English	all	01.02.2001	N. Dreilich	
V0401	Layout Technical data size Y Connector Cable designation Certificates	1.3 3 4 5.1 – 5.3 5.6 9	08.02.2002	N. Dreilich	changed correction/new new changed/new new new
V0503	Type code Technical data Torque/Speed Diagrams Connector assignment PG gland Technical data of the holding brake Shaft loads Technical data Notes	1.2 3 3.1 - 3.1.4 5.1 6 7 7.2 10	27.08.2002	N. Dreilich	complete correction new design new correction / new new Layout correction insert
V0604	SSD Drives	-	18.10.2004	N. Dreilich	LOGOS
V0706	Complete Document Overview	all	13.04.2006	N. Dreilich	Doc-Library

SSD Drives Germany

SSD Drives GMBH Head Office Heppenheim



Von-Humboldt-Straße 10 • 64646 Heppenheim
Tel: +49 6252 7982-00 • Fax: +49 6252 7982-05
www.ssddrives.com • ssd@ssddrives.de

SSD Drives GMBH Plant Servosystems



Im Sand 14 • 76669 Bad Schönborn
Tel: +49 7253 9404-0 • Fax: +49 7253 9404-99
www.ssddrives.com • ssd@ssddrives.de

SSD Drives Global

UNITED KINGDOM

SSD Drives Ltd
New Courtwick Lane
Littlehampton
West Sussex BN17 7RZ
Tel: +44 (0)1903 737000
Fax: +44 (0)1903 737100

CANADA

SSD Drives Inc.
4391 Harvester Road, Unit #1
Burlington
Ontario L7L 4X1
Tel: +1 (905) 333 7787
Fax: +1 (905) 632 0107

CHINA

SSD Drives Ltd
Room 1603, Hua Teng Edifice
302# Jin Song San Qu
Chaoyang District,
Beijing 100021
P.R. China

SSD Drives Partner

- ARGENTININA • AUSTRALIA
- AUSRIA
- BANGLADESH • BRAZIL
- CHILE • COLOMBIA
- COSTA RICA • CYPRUS
- CZECH REPUBLIC
- ECUADOR • EGYPT
- GREECE
- HONG KONG • HUNGARY
- INDIA • INDONESIA ISLAND
- ISRAEL • IRAN • IRELAND
- KUWAIT
- LITHUNIA
- MALAYSIA • MAROCCO
- MEXICO
- NETHERLANDS • NEW ZEALAND
- PERU • PHILIPPINES
- POLAND • PORTUGAL
- ROMANIA
- SAUDI ARABIA • SINGAPORE
- SLOVENIA • SPAIN
- SRI LANKA • SWITZERLAND
- TAIWAN • THAILAND
- TURKEY
- UNITED ARAB EMIRATES
- VIETNAM

DENEMARK

SSD Drives AB
Enghavevej 11
7100 Vejle
Tel: +45 (0)70 201311
Fax: +45 (0)70 201312

FRANCE

SSD Drives SAS
15 Avenue de Norvège
Villebon sur Yvette
91953 Courtaboeuf Cedex - Paris
Tel: +33 (0)1 69 18 51 51
Fax: +33 (0)1 69 18 51 59

GERMANY

SSD Drives GmbH
Von-Humboldt-Straße 10
64646 Heppenheim
Tel: +49 (6252) 7982-00
Fax: +49 (6252) 7982-05

ITALY

SSD Drives SpA
Via Gran Sasso 3
20030 Lentate Sul Seveso - MI
Tel: +39 (0362) 557308
Fax: +39 (0362) 557312

SCHWEDEN

SSD Drives AB
Montörögatan 7
30260 Halmstad
Tel: +46 (0)35-17 73 00
Fax: +46 (0)35-10 84 07

U.S.A.

SSD Drives Inc.
9225 Forsyth Park Drive
Charlotte
North Carolina 28273
Tel: +1 (704) 588 3246
Fax: +1 (704) 588 3249

www.ssddrives.com

