

# Global Vehicle Motors GVM Series

Technical Manual

PVD 3668\_GB





## EU DECLARATION OF CONFORMITY

We ,

**Parker Hannifin Manufacturing France SAS**  
**Electromechanical & Drives Division Europe**  
**Etablissement de Longvic**  
**4 Boulevard Eiffel - CS40090**  
**21604 LONGVIC Cedex - France**

manufacturer, with brand name **Parker**, declare under our sole responsibility that the products

### **BRUSHLESS SERVOMOTORS TYPE GVM**

satisfy the arrangements of the directives :

**Directive 2014/35/EU : “Low Voltage Directive”, LVD**  
**Directive 2011/65/EU : “Restriction of Hazardous Substances”, RoHS**  
**Directive 2014/30/EU : “Electromagnetic Compatibility”, EMC**

and meet standards or normative document according to :

**EN 60034-1:2010/AC:2010 : Rotating electrical machines - Part 1 : Rating and performance.**  
**EN 60034-5:2001/A1:2007 : Rotating electrical machines - Part 5 : Degrees of protection provided by the integral design of rotating electrical machines (IP code) - Classification.**  
**EN 60204-1:2006/AC:2010 : Safety of machinery – Electrical equipment of machines – Part 1 : General requirements.**

**The product itself is not impacted by the modifications made on the latest directives.**

**The undersigned hereby certify that the above mentioned model is procured in accordance with the above directives and standards.**

Further information :

**SERVOMOTORS shall be mounted on a mechanical support providing good heat conduction and not exceeding 40° C in the vicinity of the motor flange.**

The product must be installed in accordance with the instructions and recommendations contained in the operating instructions supplied with the product.

GVM142/GVM210 C.E. Marking : April 2014

Longvic, November 10<sup>th</sup> 2016

In the name of Parker  
A. ANDRIOT  
Quality Manager

Ref : DCE-GVM-001rev0

# Table of Content

<b>1. INTRODUCTION .....</b>	<b>5</b>
1.1. PURPOSE AND INTENDED AUDIENCE.....	5
1.2. SAFETY.....	5
1.2.1. Principle.....	5
1.2.2. General Safety Rules .....	6
<b>2. PRODUCT DESCRIPTION.....</b>	<b>8</b>
2.1. QUICK URL.....	8
2.2. OVERVIEW .....	8
2.3. APPLICATIONS .....	8
2.4. GENERAL TECHNICAL DATA .....	9
2.5. PRODUCT CODE .....	10
<b>3. TECHNICAL DATA .....</b>	<b>11</b>
3.1. MOTOR SELECTION.....	11
3.1.1. Altitude derating.....	11
3.1.2. Cooling temperature .....	11
3.1.3. Thermal equivalent torque (rms torque) .....	11
3.1.4. Inverter selection .....	13
3.1.5. Current limitation at stall conditions (i.e. speed < 3 rpm) .....	14
3.1.6. Peak current limitations .....	14
3.2. MOTOR CHARACTERISTICS AND INVERTER ASSOCIATION .....	16
3.2.1. Low Voltage Associations with Natural Convection .....	17
3.2.2. Low Voltage Associations with Liquid Cooling .....	19
3.2.3. High Voltage Associations with Liquid Cooling .....	21
3.2.1. Typical Efficiency Maps without Flux-Weakening .....	25
3.2.2. Time constants of the motor .....	35
3.3. DIMENSION DRAWINGS .....	37
3.3.1. GVM142 outline drawings .....	37
3.3.2. GVM210 outline drawings .....	39
3.4. MOTOR MOUNTING.....	42
3.4.1. Motor mounting environment.....	42
3.4.2. Motor mounting.....	42
3.4.3. Frame recommendation .....	43
3.4.4. Pulley/belt .....	43
3.5. BEARINGS .....	43
3.6. COOLING.....	44
3.6.1. General recommendations .....	44
3.6.2. Additives for water as cooling media .....	45
3.6.3. Flow rating according to glycol concentration .....	46
3.6.4. GVM Internal Pressure Drop .....	47
3.6.5. Chiller selection .....	49
3.6.6. Liquid cooling diagram.....	50
3.6.7. Coolant Connections : .....	52
3.7. THERMAL PROTECTION .....	53
3.7.1. Alarm tripping with PTC thermistors:.....	53
3.7.2. Temperature measurement with KTY sensors:.....	54
3.8. POWER ELECTRICAL CONNECTION .....	55
3.8.1. Cables sizes .....	55
3.8.2. Motor cable length .....	56
3.8.3. Mains supply connection diagrams .....	57
3.9. FEEDBACK SYSTEM.....	61
3.9.1. Resolver.....	61
3.9.2. Sin-Cos Encoder (low voltage application).....	62
<b>4. COMMISSIONING, USE AND MAINTENANCE .....</b>	<b>63</b>
4.1. RECEPTION, HANDLING, STORAGE .....	63
4.1.1. Equipment delivery .....	63



4.1.2.	<i>Handling</i> .....	63
4.1.3.	<i>Storage</i> .....	64
4.2.	INSTALLATION.....	64
4.2.1.	<i>Mounting</i> .....	64
4.2.2.	<i>Preparation</i> .....	65
4.2.3.	<i>Mechanical assembly</i> .....	65
4.3.	ELECTRICAL CONNECTION .....	66
4.3.1.	<i>Cable connection</i> .....	66
4.3.2.	<i>Resolver / Encoder / Thermistor cable handling</i> .....	67
4.4.	MAINTENANCE OPERATIONS .....	68
4.5.	TROUBLESHOOTING.....	69

## 1. INTRODUCTION

### 1.1. Purpose and intended audience

This manual contains information that must be observed to select, install, operate and maintain PARKER GVM motors.

Installation, operation and maintenance of the equipment should be carried out by qualified personnel. A qualified person is someone who is technically competent and familiar with all safety information and established safety practices; with the installation process, operation and maintenance of this equipment; and with all the hazards involved.

Reading and understanding the information described in this document is mandatory before carrying out any operation on the motors. If any malfunction or technical problem occurs, that has not been dealt with in this manual, please contact PARKER for technical assistance. In the case of missing information or doubts regarding the installation procedures, safety instructions or any other issue tackled in this manual, please contact PARKER directly.

PARKER's responsibility is limited to its GVM Motors and does not encompass the whole user's system. Data provided in this manual are for product description only and may not be guaranteed, unless expressly mentioned in a contract.



**DANGER:** PARKER declines responsibility for any industrial accident or material damage that may arise, if the procedures and safety instructions described in this manual are not scrupulously followed.

### 1.2. Safety



#### 1.2.1. Principle



For this equipment to work safely, it must be transported, stored, handled, installed and serviced correctly. Following the safety instructions described in each section of this document is mandatory. GVM Motors usage must also comply with all applicable standards, national directives and factory instructions in force.



**DANGER:** Non-compliance with safety instructions, legal and technical regulations in force may lead to physical injuries or death, as well as damages to the property and the environment.

## 1.2.2. General Safety Rules

	<p><b>Generality</b>  <b>DANGER:</b> The installation, commissioning and operation must be performed by qualified personnel, in conjunction with this documentation.</p> <p>The qualified personnel must know the safety (C18510 authorization, standard VDE 0105 or IEC 0364 as an example) and local regulations.</p> <p>They must be authorized to install, commission and operate in accordance with established practices and standards.</p>
	<p><b>Electrical hazard</b></p> <p>Inverters may contain non-insulated live AC or DC components. See the inverter commissioning manual. Users are advised to guard against access to live parts before installing the equipment.</p> <p>Some parts of the motor or installation elements can be subject to dangerous voltages, especially when the motor is driven by the converter or when the motor rotor is manually rotated.</p> <p>For measurements use only a meter to IEC 61010 (CAT III or higher). Always begin using the highest range. CAT I and CAT II meters must not be used on this product.</p> <p>Even after the electrical system is de-energized, voltages may be present several minutes (see inverter technical manual) until the power capacitors have had time to discharge. Use specified meter capable of measuring up to 1000V DC &amp; AC RMS to confirm that less than 50V is present between power terminals an earth. Check the inverter recommendations.</p> <p>To prevent any accidental contact with live components, it is necessary to check that cables are not damaged, stripped or not in contact with a rotational part of the machine and to study first of all the following points:</p> <ul style="list-style-type: none"> <li>- Connector lug protection</li> <li>- Correctly fitted protection and earthing features</li> <li>- Workplace insulation (enclosure insulation humidity, etc.)</li> <li>- Terminal box properly closed</li> </ul> <p>General recommendations :</p> <ul style="list-style-type: none"> <li>- Check the bonding circuit</li> <li>- Lock the electrical system</li> <li>- Use standardized equipment</li> </ul> <p>Due to particular high current values, take care of specific hazards like burning or UV flashes during shorts.</p>

	<p><b>Mechanical hazard</b> Brushless synchronous motors can accelerate in milliseconds. Running the motor can lead to other sections of the machine moving dangerously. Moving parts must be screened off to prevent operators coming into contact with them or to protect the people against a shaft failure. The working procedure must allow the operator to keep well clear of the danger area.</p>
	<p><b>Burning Hazard</b> Always bear in mind that some parts of the surface of the motor can reach temperatures exceeding 100°C.</p>

## 2. PRODUCT DESCRIPTION

### 2.1. Quick URL

All informations and datas are available on :

<http://www.parker.com/eme/mgv>

### 2.2. Overview

The GVM motors from Parker are innovative solutions, specifically designed for Mobile applications for Traction, Implement or Auxiliary functions.

The GVM motors are brushless synchronous servomotors, with permanent magnets, with a Water or Oil cooling system and a resolver / encoder speed sensor.

The water cooling increases the torque density and allows a silent operation.

These motors can also be used in a Natural Convection mode if required with corresponding performances.

As there is no current in the rotor, the losses in the rotor are very low.

#### Advantages

- High power density,
- High precision
- High motion quality
- Low inertia
- High dynamic performances
- Compact dimensions and robustness
- Large set of options and customization possibilities
- IP67 as standard ; IP6K9K on request.

### 2.3. Applications

As these motors are dedicated for Mobile applications, they have been designed for rugged atmospheres and harsh environments for :

- Traction,
- Pump,
- Auxiliaries,
- Steering.



## 2.4. General technical data

<b>Motor type</b>	Permanent-magnet synchronous motor						
<b>Magnet material</b>	Rare earth magnets						
<b>Number of poles</b>	<table border="1"> <tr> <td>Size:</td> <td>GVM142</td> <td>GVM210</td> </tr> <tr> <td>No of poles:</td> <td>12</td> <td>12</td> </tr> </table>	Size:	GVM142	GVM210	No of poles:	12	12
Size:	GVM142	GVM210					
No of poles:	12	12					
<b>Mechanical interface</b>	Different interfaces for Implement and Traction						
<b>Sizes</b> (square motor dimension)	142, 210						
<b>Degree of Protection</b>	IP67 as standard ; IP6K9K on request (IEC 60034-5)						
<b>Cooling</b>	Water cooled, Oil cooled or Natural convection						
<b>Cooling liquid temperature</b>	-20°C to 65°C depending on coolant characteristics						
<b>Rated voltage</b>	24 VDC to 800 VDC						
<b>Connections</b>	Terminal box ; Connector for feedback ; Flying cables -only for the kit version						
<b>Insulation of the stator winding</b>	Class H with potting						
<b>Random Vibration</b>	0,1 g <sup>2</sup> /Hz in frequency range 5-2000 Hz (12g rms – 3 x 8h) – (JDQ53.3)						
<b>Operational Shock</b>	25g, 11ms, 3 x 6 (with 2 directions per axis)						
<b>Thermal protection</b>	1 PTC probes and 1 KTY84-130 sensor						
<b>Operating temperature</b>	liquid cooled : -40°C...+120°C with a Resolver sensor -40°C...+85°C with a SinCos encoder sensor natural cooling : -40°C...+60°C						
<b>Storage temperature</b>	-40°C...+120°C with a Resolver sensor -40°C...+85°C with a SinCos encoder sensor						
<b>Shaft end</b>	Spline shaft (male or female), other possibilities on request						
<b>Sensor</b>	Resolver or SinCos Encoder						
<b>Marking</b>	CE						



## 2.5. Product Code

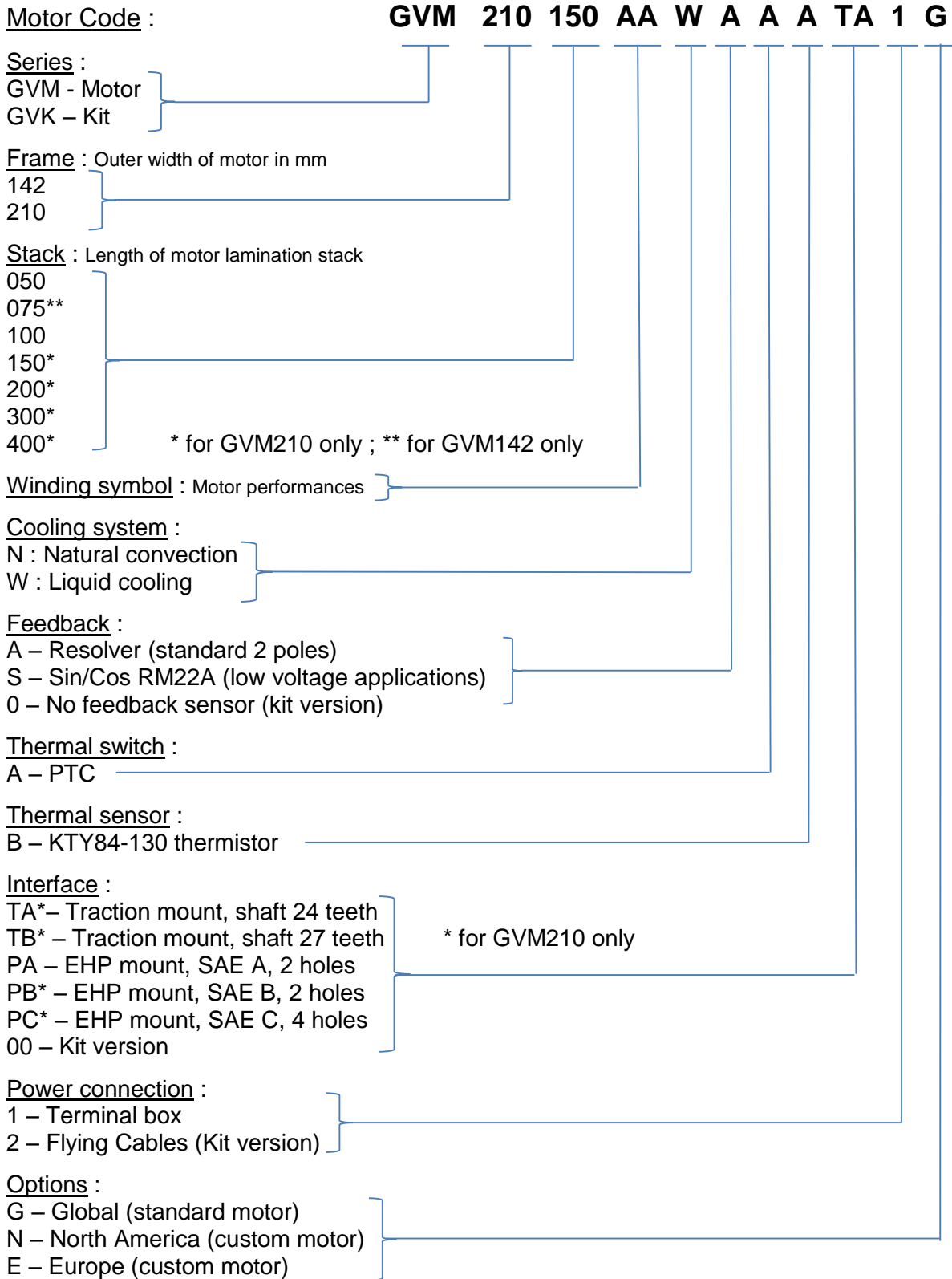

## 3. TECHNICAL DATA

### 3.1. Motor selection

#### 3.1.1. Altitude derating

From 0 to 1000 m : no derating

From 1000 to 4000 m : torque derating of 5% for each step of 1000 m for GVM motors.

#### 3.1.2. Cooling temperature

##### Water cooled motor

Standard datasheets are available for water cooling without Glycol and inlet temperatures of 25°C or 65°C (see total flow required if Glycol is added on § 3.6.3).

Parker can provide a specific datasheet for a different coolant type or coolant temperature.

#### 3.1.3. Thermal equivalent torque (rms torque)

The selection of the correct motor can be made through the calculation of the rms torque  $M_{rms}$  (i.e. root mean squared torque) (sometimes called equivalent torque).

This calculation does not take into account the thermal time constant. It can be used only if the overload time is much shorter than the copper thermal time constant.

The rms torque  $M_{rms}$  reflects the heating of the motor during its duty cycle.

Let us consider:

- the period of the cycle  $T$  [s],

- the successively samples of movements  $i$  characterized each ones by the maximal torque  $M_i$  [Nm] reached during the duration  $\Delta t_i$  [s].

So, the rms torque  $M_{rms}$  can be calculated through the following basic formula:

$$M_{rms} = \sqrt{\frac{1}{T} * \sum_{i=1}^n M_i^2 \Delta t_i}$$

Example:

For a cycle of 2s at 0 Nm and 2s at 100Nm, the rms torque is

$$M_{rms} = \sqrt{\frac{1}{4} * 100^2 * 2} = 70,7Nm$$

The maximal torque  $M_i$  delivered by the motor at each segment  $i$  of movement is obtained by the algebraic sum of the acceleration-deceleration torque and the resistant torque.

Therefore,  $M_{max}$  corresponds to the maximal value of  $M_i$ .

**Selection of the motor :**

The motor corresponding to the duty cycle has to provide the rms torque  $M_{rms}$  at the rms speed(\*) without extra heating. This means that the permanent torque  $M_n$  available at the average speed presents a sufficient margin regarding the rms torque  $M_{rms}$ .

$$\Omega_{rms} = \sqrt{\frac{1}{T} * \sum_{i=1}^n \Omega_i^2 \Delta t_i}$$

(\*) rms speed is calculated with the same formula as that used for the rms torque. The mean speed cannot be used (in general mean speed is equal to zero). Only use the rms speed

Furthermore, each  $M_i$  and speed associated  $\Omega_i$  of the duty cycle has to be located in the operational area of the torque vs speed curve.

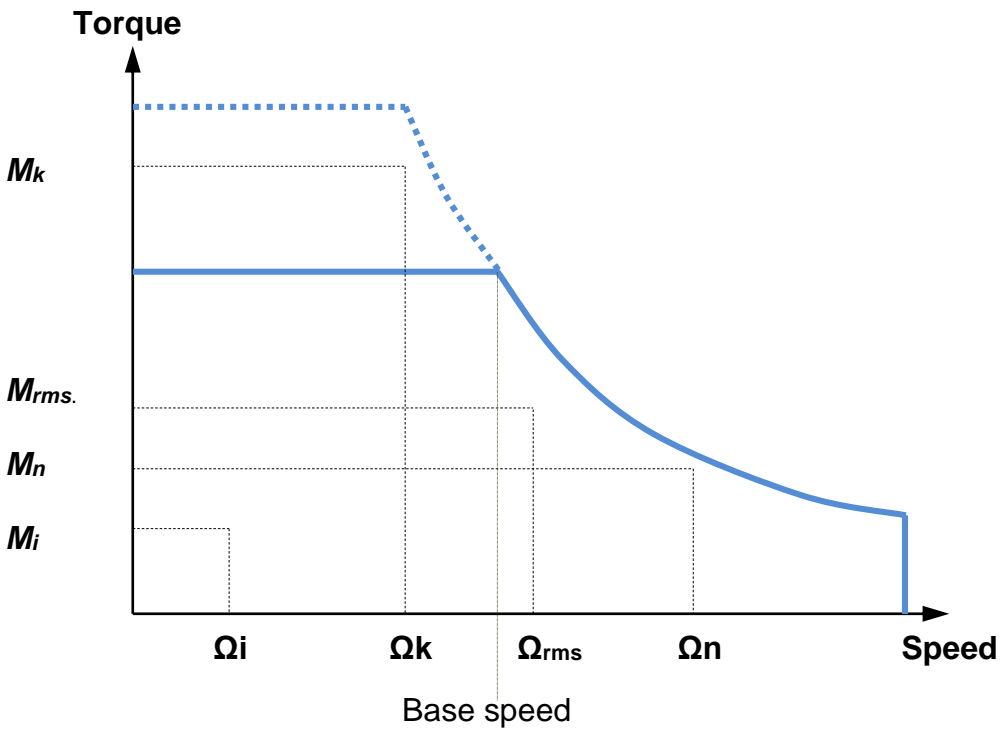



We are defining the base speed the knee of the continuous curve, not the knee of the peak curve...

### 3.1.4. Inverter selection

The Inverter selection depends on at first on the available voltage and then on its rated power, nominal current and maximum electrical frequency have to be achieved by the drive and by the flux weakening ratio.

	Please refer to the drive technical documentation for any further information and to select the best motor and drive association.
---	---

	In case of using a Low Voltage inverter that will bring high current levels, take care to the 3 phase cables cross-section and length that can affect the motor speed or its rated point.
---	---

	In flux weakening mode, please refer to the inverter technical documentation to select the appropriate inverter regarding maximum voltage and current ....
---	--

	Max back emf of the motor must be lower than the max voltage (from the motor) supported by the inverter Please refer to the drive technical documentation
---	--

	The inverter must be able to manage the flux weakening and must avoid voltage higher than the nominal motor voltage at the motor terminals. Please, check field weakening ratio supported by the inverter. Field weakening ratio = Max speed divided by the basis speed
---	---

	Due to the maximum electrical frequency able to be managed by the inverter, the motor has a speed limitation given as follows: $\text{Speed limitation (rpm)} = \frac{2 * \text{Max\_inverter\_frequency (Hz)} * 60}{\text{Number\_of\_poles}}$
---	--

### 3.1.5. Current limitation at stall conditions (i.e. speed < 3 rpm)

Recommended reduced current at speed < 3 rpm:

$$I_{reduced} = \frac{1}{\sqrt{2}} * I_0 \cong 0.7 * I_0$$



**Warning:** The current must be limited to the prescribed values. If the nominal torque has to be maintained at stop or low speed (< 3 rpm), the current must not exceed 70% of  $I_0$  (permanent current at low speed), in order to avoid any excessive overheating of the motor.



Please refer to the inverter technical documentation for any further information and to choose functions to program the drive.

### 3.1.6. Peak current limitations

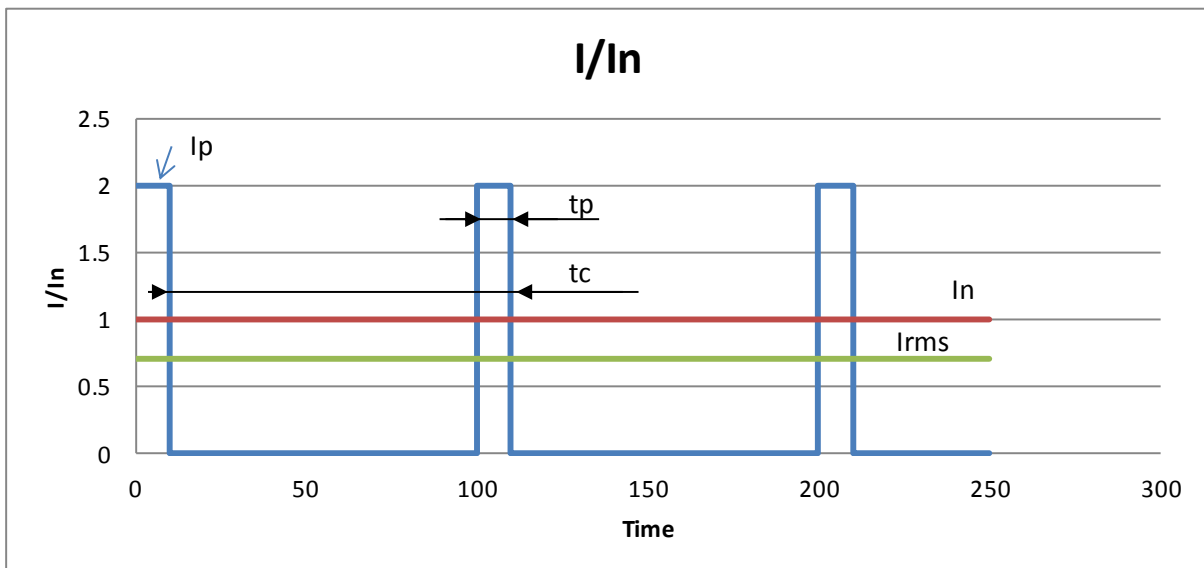

It is possible to use the GVM motors with a current higher than the permanent current ( $I_n$ ). But, to avoid any overheating, the following rules must be respected.

- 1) The peak currents and peak torques given in the data sheet must never be exceeded
- 2) The thermal equivalent torque must be respected (§3.1.3)  
 $M_{rms} \leq M_n$  or  $I_{rms} \leq I_n$

If 1) and 2) are achieved (it can limit the peak current value or duration), the peak current duration ( $t_p$ ) might be limited, in order to maintain the copper heating below the nominal heating value.



$I_p$  = Peak current

$I_n$  = Nominal current for a define speed (For low speed  $I_n=I_o$ )

$t_p$  = duration of the peak current in the cycle.

$t_c$  = duration of the cycle

$I_{rms}$  = Thermal equivalent current. (  $I_{rms}=\sqrt{(I_p^2*t_p/t_c)}$  )

$T_{cp}$  = Thermal time constanst of the copper.

$$t_p = -T_{cp} * \left[ \ln \left( 1 - \frac{1}{\left( \frac{I_p}{I_n} \right)^2} \right) - \text{Min} \left( \ln \left( 1 - \frac{(2 * \left( \frac{I_{rms}}{I_n} \right)^2 - 1)}{\left( \frac{I_p}{I_n} \right)^2} \right); 0 \right) \right]$$

$$t_c = \left( \frac{I_p}{I_{rms}} \right)^2 * t_p = \left( \frac{\frac{I_p}{I_n}}{\frac{I_{rms}}{I_n}} \right)^2 * t_p$$

**Example :**

Motor series GVM210-400-DPW

$T_{cp} = 39$  s

$I_{rms}/I_n = 0.8$

$I_p/I_n = 1.4$

$$t_p = -39 * \left[ \ln \left( 1 - \frac{1}{(1.4)^2} \right) - \text{Min} \left( \ln \left( 1 - \frac{(2 * (0.8)^2 - 1)}{(1.4)^2} \right); 0 \right) \right] = 21.8$$

$$t_c = \left( \frac{1.4}{0.8} \right)^2 * 21.8 = 66.7$$

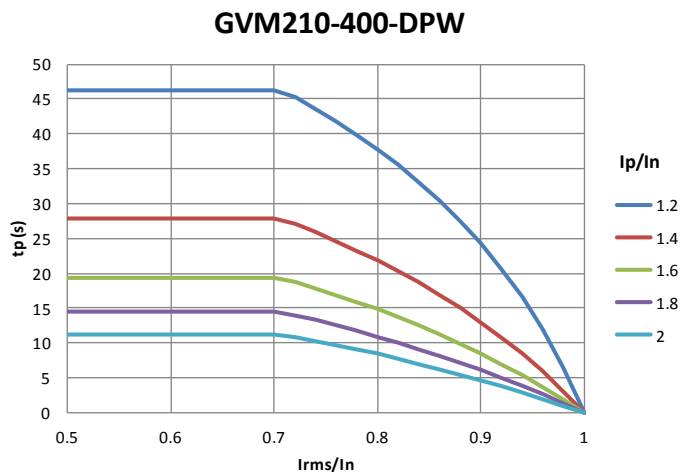
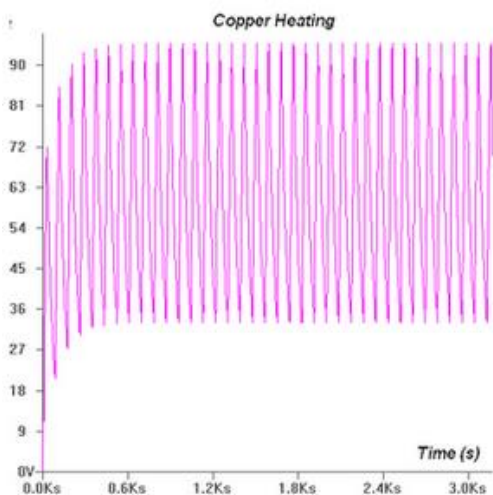

Consult us for more demanding applications.

### 3.2. Motor characteristics and inverter association

The torque vs speed graph below explains different intrinsic values of the next tables.

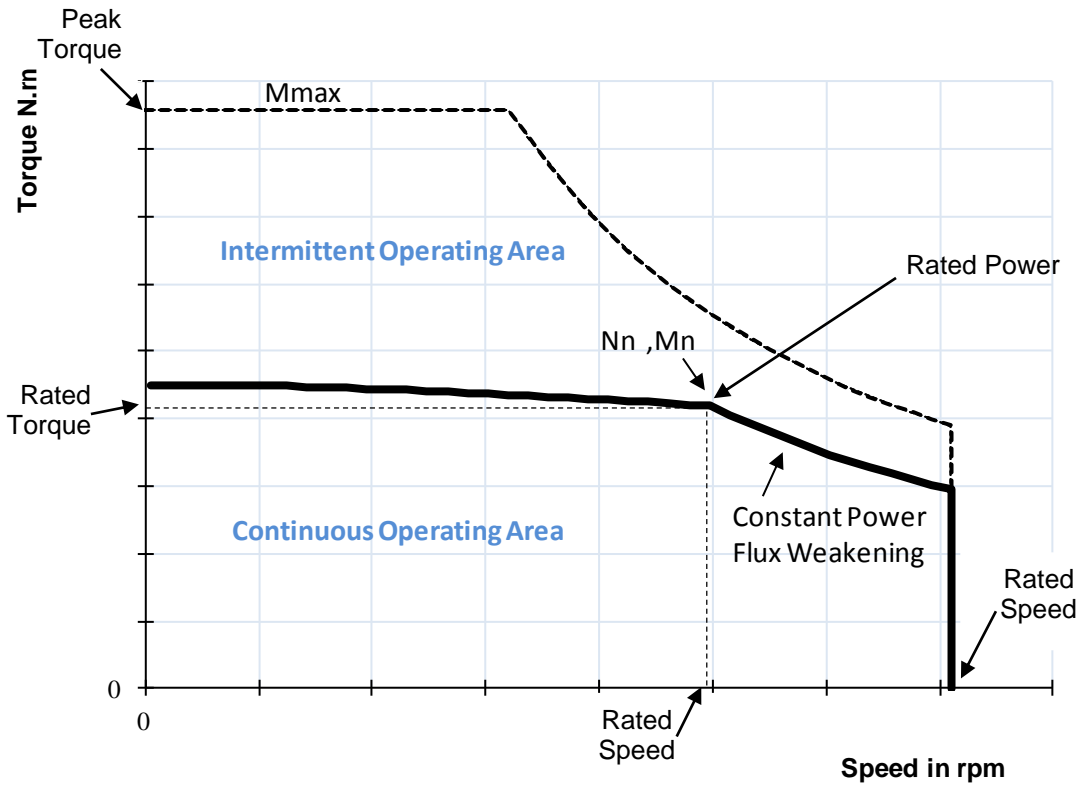





### 3.2.1. Low Voltage Associations with Natural Convection

These associations without liquid cooling are typically dedicated to EHP due to the low speed level available. GVM with a contact surface at 60°C – Characteristics given for an optimal inverter/motor association

Motor	Battery DC Voltage Supply	Rated Torque Mn (N.m)	Rated Power Pn (kW)	Rated Current In (Arms)	Rated Speed Nn (rpm)	Peak Torque Mmax (Nm)	Peak power Pp (kW)	Peak Current Ip (Arms)	Max. Speed Nmax (rpm)	Efficiency at Rated Power (%)
<b>GVM142 - Natural cooling with a contact surface at 60°C</b>										
GVM142-050-DPN	24	8.99	3.03	125	3220	40	7.2	691.1	3800	93.1
GVM142-050-GPN	36	6.74	3.18	87.1	4500	40	10.4	625.3	4900	91.7
GVM142-050-MPN	48	6.33	3.12	64	4700	40	10.9	486.4	5200	90.8
GVM142-050-YPN	72	6.74	3.18	42.6	4500	40	10.4	305.4	5000	91.4
GVM142-050-ZPN	80	6.12	3.08	37.2	4800	40	11.1	291.8	5200	90.9
GVM142-050-EQN	96	6.54	3.15	31.2	4600	40	10.6	230.4	4950	91.7
GVM142-050-NQN	120	7.87	3.22	26.1	3900	40	9.0	162.1	4400	92.5
GVM142-075-DPN	24	14.3	2.84	129	1890	62	6.7	715.4	2200	92.5
GVM142-075-DPN	36	9.36	3.43	87.5	3500	62	11.5	715.3	3500	92.8
GVM142-075-GPN	48	7.26	3.04	62.6	4000	62	14.3	647.1	4000	91.4
GVM142-075-YPN	72	10.8	3.52	44.3	3100	62	10.4	316.1	3100	93.2
GVM142-075-YPN	80	9.36	3.43	38.6	3500	62	11.7	316.1	3500	92.8
GVM142-075-ZPN	96	8.13	3.24	32.3	3800	62	13.6	302.0	3800	92.2
GVM142-075-EQN	120	8.13	3.24	25.5	3800	62	13.1	238.3	3800	92.2
GVM142-100-DPN	36	14.8	3.57	101	2300	85	11.4	742.6	2700	93.3
GVM142-100-GPN	48	11.8	3.58	73.6	2900	85	14.2	671.9	3100	92.5
GVM142-100-YPN	72	15.5	3.49	46.3	2150	85	10.2	328.1	1350	91.5
GVM142-100-YPN	80	14.4	3.61	43.2	2400	85	11.5	328.1	2650	93.2
GVM142-100-ZPN	96	12.3	3.62	35.8	2800	85	13.5	313.5	3000	92.8
GVM142-100-DQN	120	11.8	3.58	29.2	2900	85	14.1	266.2	3100	92.7
<b>GVM210 - Natural cooling with a contact surface at 60°C</b>										
GVM210-050-APN	24	22.7	3.91	176	1650	82	8.7	711.3	2100	93.4
GVM210-050-APN	36	17	5.5	134	3090	82	14.8	711.3	3300	94.5
GVM210-050-APN	48	13.2	5.23	105	3800	82	20.5	711.2	4000	93.1
GVM210-050-MPN	72	13.2	5.23	69.3	3800	82	20.4	467.4	4000	93.2
GVM210-050-SPN	80	14.3	5.39	64	3600	82	19.3	399.0	3900	93.4
GVM210-050-XPN	96	14.9	5.45	53.4	3500	82	18.7	320.8	3800	93.8
GVM210-050-DQN	120	15.1	5.47	43.9	3450	82	18.5	259.7	3800	93.7
GVM210-100-YNN	24	45	4.2	184	893	173	9.8	815.7	1100	92.7
GVM210-100-YNN	36	39.5	6.13	163	1480	173	16.2	815.7	1600	94.7
GVM210-100-YNN	48	33.1	6.93	138	2000	173	22.6	815.7	2100	95
GVM210-100-DPN	72	25.5	6.67	90.3	2500	173	29.3	685.1	2800	93.5
GVM210-100-GPN	80	27.1	6.82	82.6	2400	173	28.1	590.6	2700	93.9
GVM210-100-MPN	96	26.3	6.75	66.5	2450	173	28.0	489.4	2600	94.3
GVM210-100-SPN	120	24.7	6.58	53.3	2550	173	29.3	417.8	2700	93.9
GVM210-150-YNN	36	58.4	5.79	159	948	262	15.7	818.4	1050	93.9
GVM210-150-YNN	48	52	7.16	142	1310	262	22.1	818.3	1450	94.8
GVM210-150-APN	72	41.4	7.8	104	1800	262	31.6	747.2	2000	94.6
GVM210-150-DPN	80	40.1	7.77	93.1	1850	262	32.5	687.4	2000	94.7
GVM210-150-JPN	96	41.4	7.8	77.4	1800	262	31.5	554.3	1950	94.8
GVM210-150-QPN	120	40.1	7.77	62.9	1850	262	32.4	464.5	2000	94.6



GVM with a contact surface at 60°C – Characteristics with Low Voltage MC drive association

Motor	Drive	Battery DC Voltage Supply	Rated Torque Mn (N.m)	Rated Power Pn (kW)	Rated Current In (Arms)	Rated Speed Nn (rpm)	Peak Torque Mmax (Nm)	Peak power Pp (kW)	Peak Current Ip (Arms)	Max. Speed Nmax (rpm)	Efficiency at Rated Power (%)
<b>GVM142 - Natural cooling with a contact surface at 60°C</b>											
GVM142-050-DPN	MCD-02-0350	24	9.58	2.81	130	2800	24.6	5.6	349.9	2800	93.1
GVM142-050-DPN	MCE-03-0400	36	7.7	3.22	106	4000	27.4	10.0	399.9	4000	93.1
GVM142-050-MPN	MCE-04-0450	48	7.7	3.22	74.4	4000	38.5	11.0	449.9	4000	93.1
GVM142-050-YPN	MCD-08-0250	72	7.7	3.22	46.7	4000	35.4	10.1	250.0	4000	93.1
GVM142-075-DPN	MCD-02-0350	24	14.5	2.73	128	1800	37.6	5.5	349.9	1800	92.5
GVM142-075-DPN	MCD-04-0350	36	11.2	3.51	99.8	3000	37.6	9.4	349.9	3000	93.5
GVM142-075-XPN	MCC-04-0200	48	14.4	2.79	58.8	1850	44.4	6.0	200.0	1850	92.2
GVM142-075-GPN	MCD-04-0350	48	7.71	3.15	63.8	3900	40.7	12.1	349.9	3900	91.9
GVM142-075-YPN	MCD-08-0250	72	12	3.46	47.1	2750	54	10.1	250.0	2750	93.5
GVM142-100-BPN	MCD-02-0350	24	18	2.82	131	1500	46.1	5.8	349.9	1500	91.8
GVM142-100-DPN	MCD-04-0275	36	15.3	3.52	101	2200	41.1	8.1	275.0	2200	93.5
GVM142-100-DPN	MCD-04-0275	48	11.2	3.53	75.2	3000	41.1	11.3	275.0	3000	92.9
GVM142-100-XPN	MCD-08-0250	72	15.7	3.46	47.8	2100	70.2	10.2	250.0	2100	93.2
<b>GVM210 - Natural cooling with a contact surface at 60°C</b>											
GVM210-050-WSN	MCE-03-0500	24	14.4	4.28	199	2850	37.4	9.7	499.9	2850	93.3
GVM210-050-WSN	MCF-03-0650	24	14.4	4.28	199	2850	47.9	11.4	649.9	2850	93.3
GVM210-050-VSN	MCE-03-0500	24	15.2	3.98	181	2500	42.9	9.3	499.9	2500	93.7
GVM210-050-VSN	MCF-03-0650	24	15.2	3.98	181	2500	54.4	10.7	649.9	2500	93.7
GVM210-050-XSN	MCF-03-0650	24	11.3	4.03	188	3400	41	12.0	649.9	3400	93.2
GVM210-050-FPN	MCE-04-0350	48	17.4	5.48	115	3000	52.9	13.3	349.9	3000	94.7
GVM210-050-FPN	MCE-04-0450	48	17.4	5.48	115	3000	65.4	14.7	449.9	3000	94.7
GVM210-100-XSN	MCF-03-0650	24	27.2	4.69	214	1650	84.7	11.8	649.9	1650	93.1
GVM210-100-VSN	MCF-04-0650	48	21.5	5.62	126	2500	112	24.2	649.9	2500	93.5



### 3.2.2. Low Voltage Associations with Liquid Cooling

GVM with input coolant at 65°C – Characteristics given for an optimal inverter/motor association

Motor	Battery DC Voltage Supply	Rated Torque Mn (N.m)	Rated Power Pn (kW)	Rated Current In (Arms)	Rated Speed Nn (rpm)	Peak Torque Mmax (Nm)	Peak power Pp (kW)	Peak Current Ip (Arms)	Max. Speed Nmax (rpm)	Pure Water Flow (l/min)	Efficiency at Rated Power (%)
<b>GVM142 - Three-phased - Liquid cooled at 65°C</b>											
GVM142-050-MPW	24	18.4	3.47	178	1800	40	4.6	486.7	2700	0.8	87.5
GVM142-050-MPW	36	18.2	5.73	177	3000	40	7.9	486.7	4500	0.87	91
GVM142-050-MPW	48	18.1	7.94	175	4200	40	11.0	486.7	6300	0.96	92.4
GVM142-050-MPW	72	17.6	12	172	6500	40	17.0	486.6	9750	1.19	93.1
GVM142-050-MPW	80	17.4	13.1	171	7200	40	18.9	486.6	9500	1.28	93.2
GVM142-050-YPW	96	17.8	10.1	109	5400	40	14.2	305.6	8100	1.07	92.9
GVM142-050-ZPW	120	17.6	11.8	103	6400	40	16.7	292.0	9500	1.18	93.2
GVM142-075-MPW	24	29	3.39	182	1110	62	4.4	503.6	1650	1.11	83.8
GVM142-075-MPW	36	29	5.81	183	1910	62	7.8	503.5	2850	1.17	89.1
GVM142-075-MPW	48	29	7.9	183	2600	62	10.9	503.5	3900	1.23	91
GVM142-075-MPW	72	28.5	12.3	181	4100	62	17.0	503.5	6150	1.39	92.9
GVM142-075-MPW	80	28.3	13.9	180	4700	62	19.1	503.5	7050	1.47	93.2
GVM142-075-MPW	96	28	16.4	178	5600	62	23.1	503.5	8400	1.61	93.5
GVM142-075-MPW	120	27.4	19.8	175	6900	62	28.4	503.5	9500	1.83	93.6
GVM142-100-MPW	24	40	3.38	187	806	85	3.9	523.0	1200	1.42	80.2
GVM142-100-MPW	36	40	5.88	187	1400	85	7.6	523.0	2100	1.46	86.9
GVM142-100-MPW	48	39.9	8.15	187	1950	85	10.7	523.0	2925	1.51	89.6
GVM142-100-MPW	72	39.4	12.4	185	3000	85	16.9	523.0	4500	1.64	92.1
GVM142-100-MPW	80	39.2	14	185	3400	85	19.0	523.0	5100	1.7	92.6
GVM142-100-MPW	96	38.8	17.1	183	4200	85	23.2	523.0	6300	1.82	93.2
GVM142-100-MPW	120	38.2	20.8	180	5200	85	28.6	523.0	7800	2.01	93.6
<b>GVM210 - Three-phased - Liquid cooled at 65°C</b>											
GVM210-050-DPW	24	38.7	5.66	272	1400	82	8.4	654.8	2100	0.89	91.1
GVM210-050-DPW	36	38.4	9.03	271	2250	82	13.6	654.8	3370	0.97	93.6
GVM210-050-DPW	48	38.1	12.3	269	3100	82	18.7	654.8	4650	1.08	94.6
GVM210-050-DPW	72	37.3	18.3	265	4690	82	28.9	654.8	7050	1.35	95.2
GVM210-050-DPW	80	37	20.9	263	5390	82	32.3	654.7	8000	1.49	95.3
GVM210-050-DPW	96	36.4	24.3	260	6390	82	39.0	654.7	8000	1.71	95.3
GVM210-050-JPW	120	36.4	24.3	209	6390	82	38.5	528.0	8000	1.71	95.3
GVM210-100-DPW	36	88.2	9.7	300	1050	173	13.3	685.8	1570	1.63	90.7
GVM210-100-DPW	48	87.8	13.3	299	1450	173	18.7	685.8	2170	1.7	92.7
GVM210-100-DPW	72	86.9	20	297	2200	173	29.3	685.8	3300	1.86	94.5
GVM210-100-DPW	80	86.5	22.6	296	2500	173	32.9	685.8	3750	1.94	94.9
GVM210-100-DPW	96	85.7	26.9	293	3000	173	39.7	685.8	4500	2.08	95.3
GVM210-100-DPW	120	84.4	33.6	290	3800	173	49.1	685.8	5700	2.33	95.7
GVM210-150-DPW	48	138	13	310	900	262	18.1	688.2	1350	2.32	90.3
GVM210-150-DPW	72	137	20.8	308	1450	262	28.9	688.2	2170	2.45	93.3
GVM210-150-DPW	80	136	22.9	307	1600	262	32.5	688.2	2400	2.5	93.7
GVM210-150-DPW	96	136	27.7	305	1950	262	39.6	688.1	2920	2.61	94.5
GVM210-150-DPW	120	134	34.4	303	2450	262	48.9	688.1	3670	2.78	95.2
GVM210-200-DPW	72	186	20.5	312	1050	352	28.4	692.3	1575	3.03	91.8
GVM210-200-DPW	80	186	23.3	312	1200	352	32.0	692.3	1800	3.08	92.6
GVM210-200-DPW	96	185	28.1	310	1450	352	39.2	692.3	2175	3.16	93.6
GVM210-200-DPW	120	183	34.6	308	1800	352	48.6	692.3	2700	3.3	94.5
GVM210-300-DPW	80	283	22.5	314	760	530	30.8	692.3	1140	4.18	90
GVM210-300-DPW	96	282	28	314	950	530	38.1	692.3	1420	4.26	91.6
GVM210-300-DPW	120	281	33.8	312	1150	530	47.5	692.3	1720	4.35	92.8
GVM210-400-DPW	120	376	33.4	312	850	710	46.4	695.4	1275	5.4	91.1



GVM with input coolant at 65°C – Characteristics with Low Voltage MC drive association

Motor	Drive	Battery DC Voltage Supply	Rated Torque Mn (N.m)	Rated Power Pn (kW)	Rated Current In (Arms)	Rated Speed Nn (rpm)	Peak Torque Mmax (Nm)	Peak power Pp (kW)	Peak Current Ip (Arms)	Max. Speed Nmax (rpm)	Pure Water Flow (l/min)	Efficiency at Rated Power (%)
<b>GVM142 - Three-phased - Liquid cooled at 65°C</b>												
GVM142-050-MPW	MCE-04-0450	48	18.1	7.4	177	3900	38.4	11.0	449.9	3900	0.96	92.1
GVM142-050-BQW	MCD-08-0250	72	18.2	6.11	97.8	3200	38.6	9.1	250.0	3200	0.9	91.3
GVM142-050-XPW	MCE-08-0350	72	16	6.53	102	3900	40	11.4	314.9	3900	0.96	92.5
GVM142-075-MPW	MCE-04-0450	48	29	7.44	185	2450	58.5	10.9	449.9	2450	1.23	90.5
GVM142-075-MPW	MCF-08-0550	72	28.6	11.4	183	3800	62	17.9	492.3	3800	1.4	92.5
GVM142-100-MPW	MCF-08-0650	72	39.5	11.6	188	2800	85	17.8	509.0	2800	1.65	91.7
GVM142-100-MPW	MCF-09-0650	96	39	15.5	186	3800	85	24.5	509.0	3800	1.82	92.9
<b>GVM210 - Three-phased - Liquid cooled at 65°C</b>												
GVM210-050-DPW	MCF-04-0650	48	38.2	11.4	269	2850	81.2	17.6	649.9	2850	1.09	94.4
GVM210-050-QPW	MCF-08-0550	72	38.1	11.6	181	2900	82	18.2	445.5	2900	1.09	94.3
GVM210-050-QPW	MCF-09-0650	96	37.7	15.8	180	4000	82	24.9	445.4	4000	1.29	95
GVM210-100-FPW	MCF-04-0650	48	88	11.1	278	1200	173	16.3	638.3	1200	1.68	91.4
GVM210-100-SPW	MCF-08-0550	72	88	11.1	183	1200	173	16.3	420.3	1200	1.69	91.3
GVM210-100-QPW	MCF-09-0650	96	87	16.9	201	1850	173	25.1	465.8	1850	1.83	93.7
GVM210-150-YNW	MCF-09-0650	96	75	17.3	201	2200	222	41.8	649.9	2200	2.75	95.8



### 3.2.3. High Voltage Associations with Liquid Cooling

GVM with input coolant at 65°C – Characteristics given for an optimal inverter/motor association

Motor	Battery DC Voltage Supply	Rated Torque Mn (N.m)	Rated Power Pn (kW)	Rated Current In (Arms)	Rated Speed Nn (rpm)	Peak Torque Mmax (Nm)	Peak power Pp (kW)	Peak Current Ip (Arms)	Max. Speed Nmax (rpm)	Pure Water Flow (l/min)	Efficiency at Rated Power (%)
<b>GVM142 - Three-phased - Liquid cooled at 65°C</b>											
GVM142-050-XQW	320	17.6	12.3	39	6700	40	17.3	110.4	9500	1.21	93.1
GVM142-050-DRW	400	17.6	12.2	30.7	6600	40	17.1	87.0	9500	1.2	93.1
GVM142-050-HRW	480	17.6	11.9	25.1	6470	40	16.8	71.0	9500	1.2	93
GVM142-050-RRW	640	17.7	11.5	18.1	6220	40	16.1	51.1	8890	1.16	92.9
GVM142-075-NQW	320	27.6	18.5	58.8	6400	62	25.9	167.8	9500	1.74	93.4
GVM142-075-SQW	400	27.5	19.3	48.9	6700	62	27.2	140.1	9500	1.79	93.6
GVM142-075-XQW	480	27.5	19	39.9	6600	62	26.6	114.2	9500	1.78	93.5
GVM142-075-ERW	640	27.6	18.7	29.5	6500	62	26.3	84.4	9500	1.76	93.4
GVM142-100-EQW	320	37	26.3	83.1	6800	85	37.2	247.7	9500	2.36	93.9
GVM142-100-NQW	400	37.6	23.6	59.4	6000	85	32.8	174.3	9000	2.18	93.6
GVM142-100-SQW	480	37.6	23.6	49.6	6000	85	32.9	145.6	9000	2.18	93.8
GVM142-100-ZQW	640	37.5	23.8	37.2	6050	85	33.1	109.5	8570	2.19	94
<b>GVM210 - Three-phased - Liquid cooled at 65°C</b>											
GVM210-050-QQW	320	36.9	21.2	66.4	5490	82	32.9	165.3	8000	1.51	95.3
GVM210-050-VQW	400	36.8	22.1	55	5740	82	34.4	137.6	8000	1.56	95.2
GVM210-050-VQW	480	36	26.2	54.1	6940	82	41.4	137.5	8000	1.85	95.1
GVM210-050-FRW	640	36	26	40	6890	82	40.9	101.7	8000	1.83	95.1
GVM210-100-SPW	320	78.6	53.5	166	6500	173	82.3	418.1	8000	3.45	95.7
GVM210-100-XPW	400	78.6	53.5	133	6500	173	83.2	336.1	8000	3.45	95.9
GVM210-100-DQW	480	79.1	52.2	108	6300	173	81.0	272.1	8000	3.35	95.9
GVM210-100-MQW	640	78.3	54.1	83.6	6600	173	84.3	211.6	8000	3.5	95.6
GVM210-150-DPW	320	115	84.1	262	7000	262	136.5	687.9	8000	5.34	95.9
GVM210-150-JPW	400	114	84.9	210	7100	262	138.1	554.7	8000	5.41	95.8
GVM210-150-SPW	480	118	80	163	6500	262	125.6	419.5	8000	4.99	95.9
GVM210-150-ZPW	640	118	80	122	6500	262	125.1	312.7	8000	4.99	96
GVM210-200-DPW	320	164	89.4	278	5200	352	137.1	692.1	7800	5.35	96.2
GVM210-200-DPW	400	152	105	259	6610	352	172.2	692.0	8000	6.49	96
GVM210-200-JPW	480	154	103	211	6410	352	167.0	558.1	8000	6.32	96
GVM210-200-SPW	640	153	104	159	6510	352	168.8	421.9	8000	6.41	96
GVM210-300-DPW	320	262	93.2	293	3400	530	136.9	692.2	5100	5.85	96.2
GVM210-300-DPW	400	251	113	281	4300	530	172.1	692.1	6450	6.66	96.3
GVM210-300-DPW	480	238	132	267	5300	530	207.6	692.0	7950	7.68	96.3
GVM210-300-DPW	640	205	155	232	7220	530	277.8	691.9	8000	9.83	95.8
GVM210-400-DPW	320	358	93.6	299	2500	710	136.0	695.3	3750	6.59	95.8
GVM210-400-DPW	400	348	116	290	3190	710	172.0	695.2	4800	7.27	96.2
GVM210-400-DPW	480	336	137	281	3900	710	207.6	695.1	5850	8.03	96.4
GVM210-400-DPW	640	306	170	257	5310	710	278.6	695.0	7950	9.76	96.3



GVM with input coolant at 65°C – Characteristics with High Voltage MD drive association

Motor	Drive	Battery DC Voltage Supply	Rated Torque Mn (N.m)	Rated Power Pn (kW)	Rated Current In (Arms)	Rated Speed Nn (rpm)	Peak Torque Mp (N.m)	Peak Power Pp (kW)	Peak Current Ip (Arms)	Max Speed Np (rpm)	Pure Water Flow (l/min)	Efficiency at Rated Power (%)
<b>GVM142 - Three-phased - Liquid cooled at 65°C</b>												
GVM142-050-RRW	MD-4A-80-024-00	320	18.3	5.68	18.5	2970	23.3	6.4	24.0	8500	0.9	90.6
GVM142-050-RRW	MD-4A-80-024-00	480	18	8.63	18.4	4580	23.3	9.9	24.0	9450	1	92.4
GVM142-050-HRW	MD-4A-80-053-00	320	18.1	7.94	25.6	4200	33.2	10.7	53.0	9500	1	92.2
GVM142-050-HRW	MD-4A-80-053-00	480	17.6	11.9	25.1	6480	33.2	16.5	53.0	9500	1.2	93
GVM142-075-RRW	MD-4A-80-024-00	320	28.7	5.75	19	1910	35.6	6.3	24.0	5800	1.2	88.7
GVM142-075-RRW	MD-4A-80-024-00	480	28.6	8.88	19	2960	35.6	9.9	24.0	6160	1.3	91.5
GVM142-075-RRW	MD-4A-80-024-00	640	28.5	11.9	19	4000	35.6	13.4	24.0	6160	1.4	92.6
GVM142-075-HRW	MD-4A-80-053-00	320	29	8.14	26.8	2680	50.7	10.7	53.0	8080	1.3	90.8
GVM142-075-HRW	MD-4A-80-053-00	480	28.5	12.4	26.4	4150	50.7	16.6	53.0	8560	1.4	92.7
GVM142-075-HRW	MD-4A-80-053-00	640	27.9	16.5	26	5650	50.7	22.4	53.0	8560	1.7	93.3
GVM142-075-NQW	MD-4B-40-300-00	320	27.6	18.5	58.8	6400	62	26.1	167.8	9500	1.8	93.4
GVM142-100-RRW	MD-4A-80-024-00	320	38.8	5.71	19	1410	47.9	6.1	24.0	4000	1.5	86.8
GVM142-100-RRW	MD-4A-80-024-00	480	38.6	8.92	19	2210	47.9	9.8	24.0	4570	1.6	90.4
GVM142-100-RRW	MD-4A-80-024-00	640	38.5	12.1	19	2990	47.9	13.3	24.0	4570	1.7	92
GVM142-100-HRW	MD-4A-80-053-00	320	39.9	8.15	27.3	1950	68	10.5	53.0	5800	1.6	89.2
GVM142-100-HRW	MD-4A-80-053-00	480	39.4	12.5	27	3040	68	16.4	53.0	6350	1.7	91.9
GVM142-100-HRW	MD-4A-80-053-00	640	38.8	16.8	26.7	4130	68	22.2	53.0	6350	1.9	93
GVM142-100-CQW	MD-4B-40-300-00	320	36.3	28.9	91.4	7600	80.2	42.1	250.0	9500	2.6	93.9



Motor	Drive	Battery DC Voltage Supply	Rated Torque Mn (N.m)	Rated Power Pn (kW)	Rated Current In (Arms)	Rated Speed Nn (rpm)	Peak Torque Mp (N.m)	Peak Power Pp (kW)	Peak Current Ip (Arms)	Max Speed Np (rpm)	Pure Water Flow (l/min)	Efficiency at Rated Power (%)
<b>GVM210 - Three-phased - Liquid cooled at 65°C</b>												
GVM210-050-QRW	MD-4A-80-053-00	320	38.4	9.26	29.5	2310	65.7	12.4	53.0	5600	1	93.3
GVM210-050-QRW	MD-4A-80-053-00	480	37.9	14	29.3	3530	65.7	19.1	53.0	7250	1.1	94.6
GVM210-050-QRW	MD-4A-80-053-00	640	37.3	18.6	28.9	4770	65.7	25.7	53.0	7250	1.4	95
GVM210-100-QRW	MD-4A-80-053-00	320	88.2	9.83	32.7	1070	135	12.2	53.0	3200	1.6	90.2
GVM210-100-QRW	MD-4A-80-053-00	480	87.5	15.1	32.6	1650	135	19.0	53.0	3500	1.7	92.9
GVM210-100-QRW	MD-4A-80-053-00	640	86.8	20.4	32.4	2240	135	25.8	53.0	3500	1.9	94.2
GVM210-100-DQW	MD-4B-40-300-00	320	83.9	36	114	4100	163	51.8	250.0	6740	2.4	95.8
GVM210-100-DQW	MD-4B-40-300-00	400	81.7	44.5	112	5200	163	65.2	250.0	6740	2.9	95.9
GVM210-100-FQW	MD-4C-80-400-00	320	84.5	33.2	105	3750	173	48.7	248.4	8000	2.3	95.6
GVM210-100-FQW	MD-4C-80-400-00	480	80.4	48.4	100	5750	173	73.9	248.4	8000	3.1	95.8
GVM210-100-ZPW	MD-4C-80-400-00	320	76.9	37.9	120	4700	169	61.3	300.0	8000	2.7	96
GVM210-150-DQW	MD-4B-40-300-00	320	134	37.1	120	2650	247	51.7	250.0	4440	2.9	95.5
GVM210-150-DQW	MD-4B-40-300-00	400	131	46.7	118	3400	247	65.1	250.0	4440	3.2	95.9
GVM210-150-FQW	MD-4C-80-400-00	320	134	34.2	110	2430	262	48.5	249.2	7300	2.8	95.1
GVM210-150-FQW	MD-4C-80-400-00	480	130	51.1	106	3750	262	74.1	249.2	7660	3.4	95.9
GVM210-150-FQW	MD-4C-80-400-00	640	124	66.5	102	5100	262	99.6	249.2	7660	4.1	96.1
GVM210-150-ZPW	MD-4C-80-400-00	320	117	37.4	120	3050	253	61.4	300.0	8000	3	96
GVM210-150-ZPW	MD-4C-80-400-00	480	117	57.6	120	4700	253	93.4	300.0	8000	3.9	96.2
GVM210-200-DQW	MD-4B-40-300-00	320	180	37.3	120	1980	331	51.2	250.0	3310	3.4	95
GVM210-200-DQW	MD-4B-40-300-00	400	180	47.3	120	2500	331	64.7	250.0	3310	3.6	95.5
GVM210-200-FQW	MD-4C-80-400-00	320	183	34.6	112	1800	352	48.4	250.7	5500	3.3	94.4
GVM210-200-FQW	MD-4C-80-400-00	480	179	51.6	109	2750	352	74.0	250.7	5710	3.7	95.6
GVM210-200-FQW	MD-4C-80-400-00	640	174	68.3	106	3750	352	99.7	250.7	5710	4.3	96.1
GVM210-200-ZPW	MD-4C-80-400-00	320	157	37	120	2250	336	61.2	300.0	5700	3.5	95.7
GVM210-200-ZPW	MD-4C-80-400-00	480	157	57.6	120	3500	336	93.4	300.0	7170	4.2	96.2
GVM210-200-ZPW	MD-4C-80-400-00	640	157	77.3	121	4700	336	125.5	300.0	7170	5	96.3
GVM210-300-DQW	MD-4B-40-300-00	320	272	36.5	120	1280	498	50.3	250.0	2200	4.4	93.6
GVM210-300-DQW	MD-4B-40-300-00	400	271	46	120	1620	498	63.9	250.0	2200	4.6	94.6
GVM210-300-FQW	MD-4C-80-400-00	320	281	34.4	113	1170	530	47.2	250.7	3500	4.4	92.7
GVM210-300-FQW	MD-4C-80-400-00	480	276	52.1	111	1800	530	73.2	250.7	3790	4.7	94.6
GVM210-300-FQW	MD-4C-80-400-00	640	271	69.5	110	2450	530	99.1	250.7	3790	5.1	95.5
GVM210-300-ZPW	MD-4C-80-400-00	320	238	37.1	120	1490	505	60.2	300.0	3600	4.5	94.8
GVM210-300-ZPW	MD-4C-80-400-00	480	238	57.3	120	2300	505	92.8	300.0	4750	5	95.9
GVM210-300-ZPW	MD-4C-80-400-00	640	238	77.3	121	3100	505	125.2	300.0	4750	5.6	96.3
GVM210-400-DQW	MD-4B-40-300-00	320	365	36.3	120	950	665	49.1	250.0	1640	5.5	92.3
GVM210-400-DQW	MD-4B-40-300-00	400	364	45.8	120	1200	665	62.9	250.0	1640	5.6	93.5
GVM210-400-FQW	MD-4C-80-400-00	320	376	33.8	113	860	710	46.0	251.8	2600	5.4	91
GVM210-400-FQW	MD-4C-80-400-00	480	371	52.1	112	1340	710	72.2	251.8	2830	5.7	93.6
GVM210-400-FQW	MD-4C-80-400-00	640	367	69.1	111	1800	710	98.3	251.8	2830	6	94.8
GVM210-400-ZPW	MD-4C-80-400-00	320	318	36.6	120	1100	676	59.1	300.0	2500	5.5	93.9
GVM210-400-ZPW	MD-4C-80-400-00	480	318	56.6	120	1700	676	91.9	300.0	3550	5.9	95.3
GVM210-400-ZPW	MD-4C-80-400-00	640	318	76.6	120	2300	676	124.5	300.0	3550	6.4	96



GVM with input coolant at 25°C – Characteristics given for an optimal inverter/motor association

Motor	Rated Power Pn (kW)	Rated Torque Mn (Nm)	Rated Speed Nn [rpm]	Rated Current In [Arms]	Low Speed Torque Mo [Nm]	Low speed Current Io [Arms]	Peak Torque Mpeak [Nm]	Peak Current I peak [Arms]	Max. Speed Nmax [rpm]
<b>400 VAC power supply - three-phased - water cooled at 25°C</b>									
GVM210-100-FRW	28.4	110	2470	59.5	112.0	60.3	173	107	4970
GVM210-100-QQW	46.1	107	4100	94.8	112.00	98	173	173	8000
GVM210-100-FQW	65.1	104	5990	132.0	112.00	141	173	249	8000
GVM210-200-HQW	64.7	228	2700	135.0	235.0	138	352	237	5410
GVM210-200-ZPW	84.5	224	3600	176.0	235.0	183	352	315	7160
GVM210-200-QPW	122	213	5500	248.0	235.0	272	352	468	8000
GVM210-400-JPW	150	448	3200	308.0	475.0	326	710	561	6300
GVM210-400-LPW	142	450	3000	292.0	475.0	307	710	527	5890
GVM210-400-XPW	92.3	464	1900	194.0	475.0	198	710	341	3830

Motor	Ke [Vrms/krpm]	Kt (sine) [Nm/Arms]	Winding Resistance [ohms]	Inductance [mH]	Moment of Inertia J [kg.m²]	Water Flow [l/min]
GVM210-100-FRW	121	1.860	0.2170	3.150	0.0173	3.1
GVM210-100-QQW	74.2	1.140	0.0778	1.190	0.0173	3.7
GVM210-100-FQW	51.7	0.797	0.0385	0.579	0.0173	4.6
GVM210-200-HQW	111	1.700	0.0771	1.310	0.035	5.8
GVM210-200-ZPW	83.9	1.280	0.0395	0.744	0.035	6.5
GVM210-200-QPW	56.4	0.863	0.0189	0.337	0.035	8.1
GVM210-400-JPW	95.4	1.460	0.0230	0.466	0.07	11.2
GVM210-400-LPW	102	1.550	0.0275	0.528	0.07	10.9
GVM210-400-XPW	157	2.390	0.0588	1.260	0.07	9.7



### 3.2.1. Typical Efficiency Maps without Flux-Weakening



Caution: The efficiency curves are typical values. They may vary from one motor to another



Caution: The efficiency curves are given for an optimal motor control (no voltage saturation and optimal phase between current and EMF)



Caution: The efficiency curves do not include the losses due to the switching frequency.



GVM142-050 in Motor operation mode :

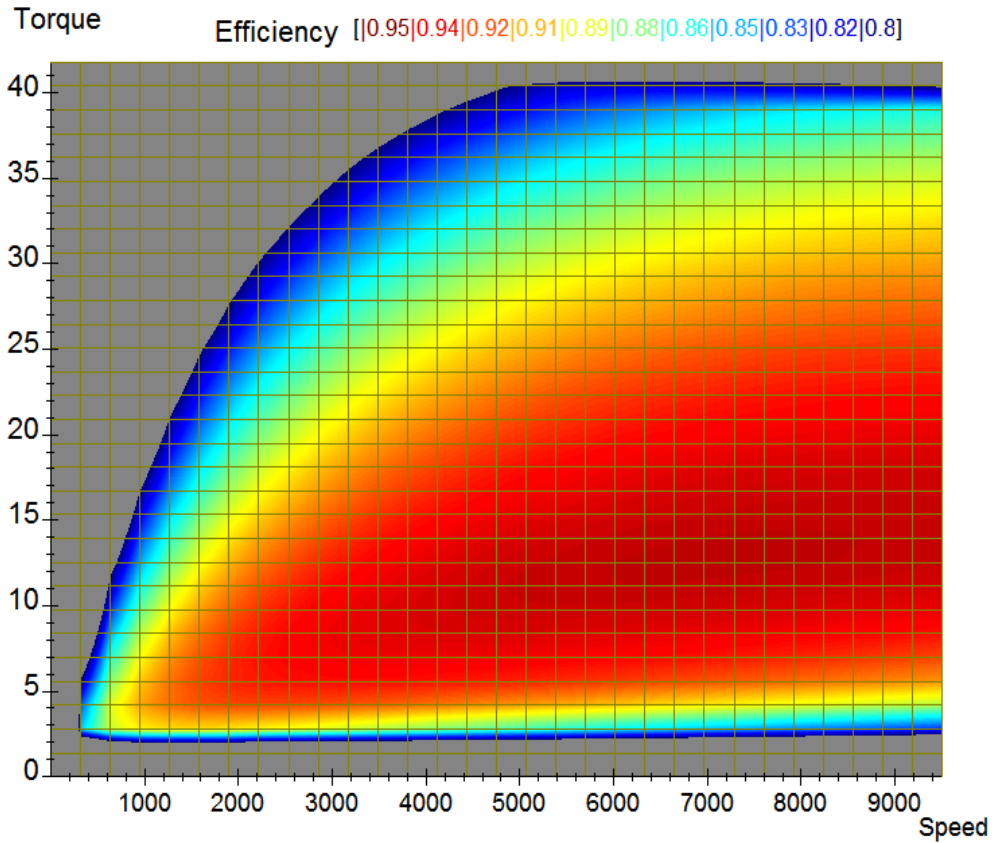

GVM142-050 in Generator operation mode :

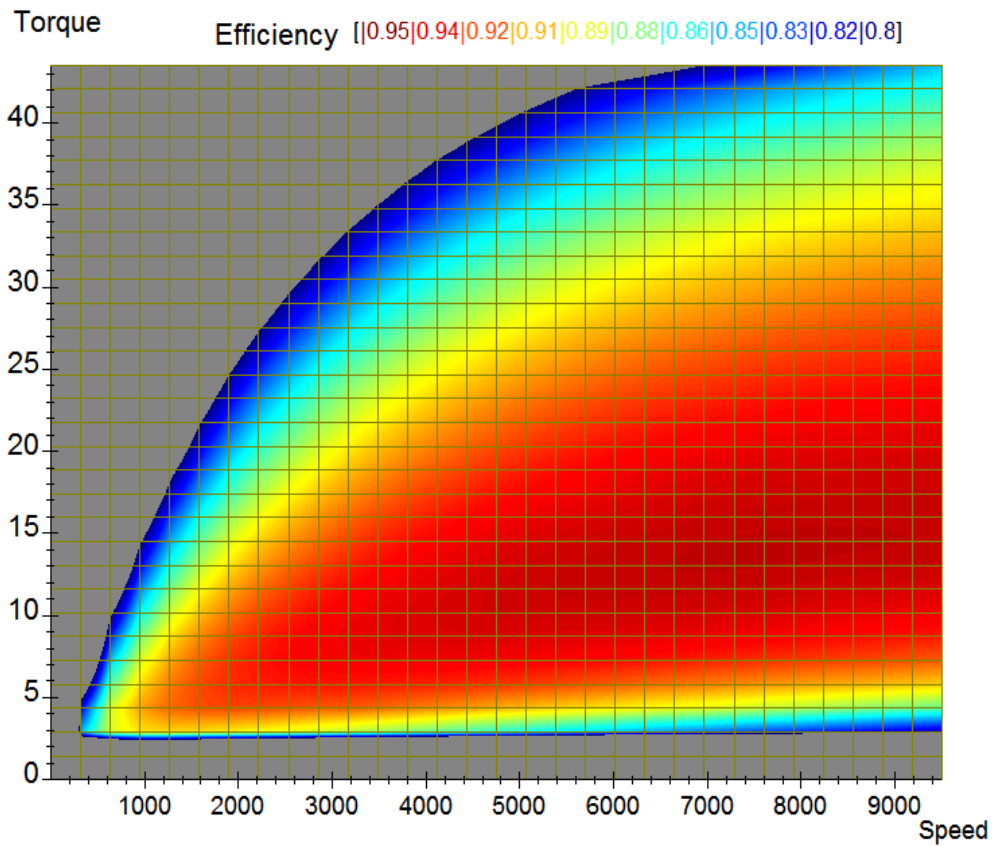



GVM142-075 in Motor operation mode :

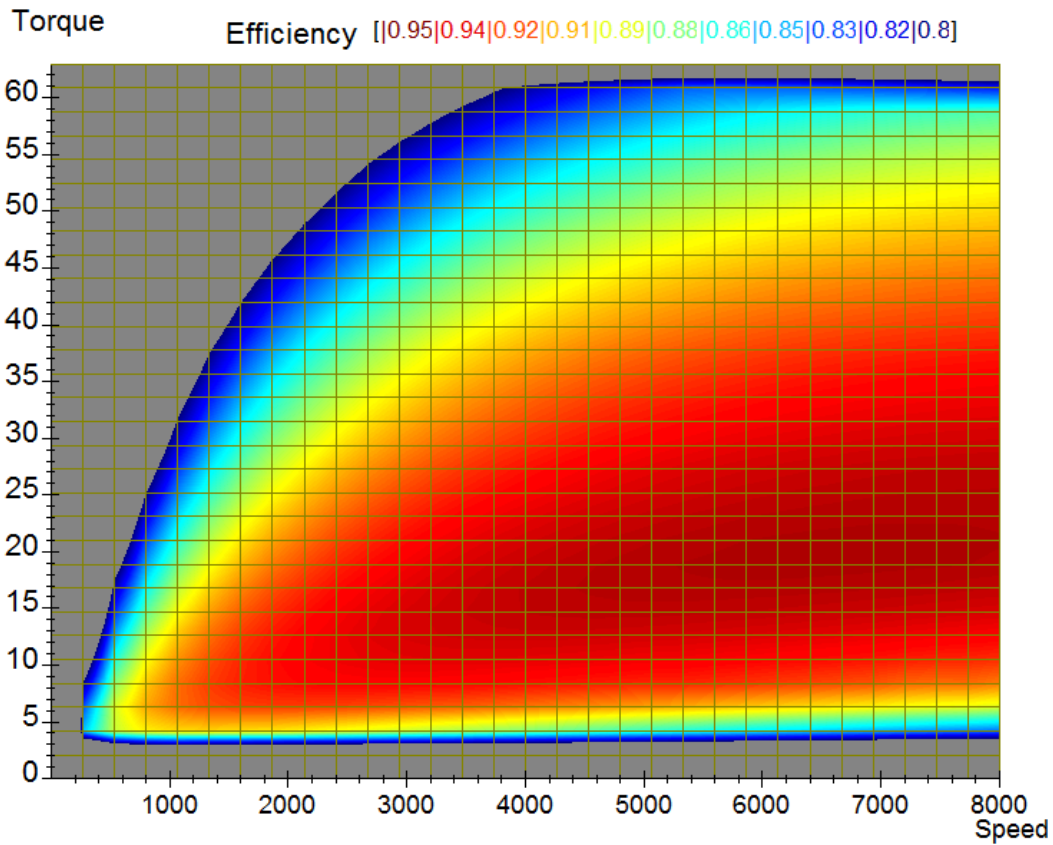

GVM142-075 in Generator operation mode :

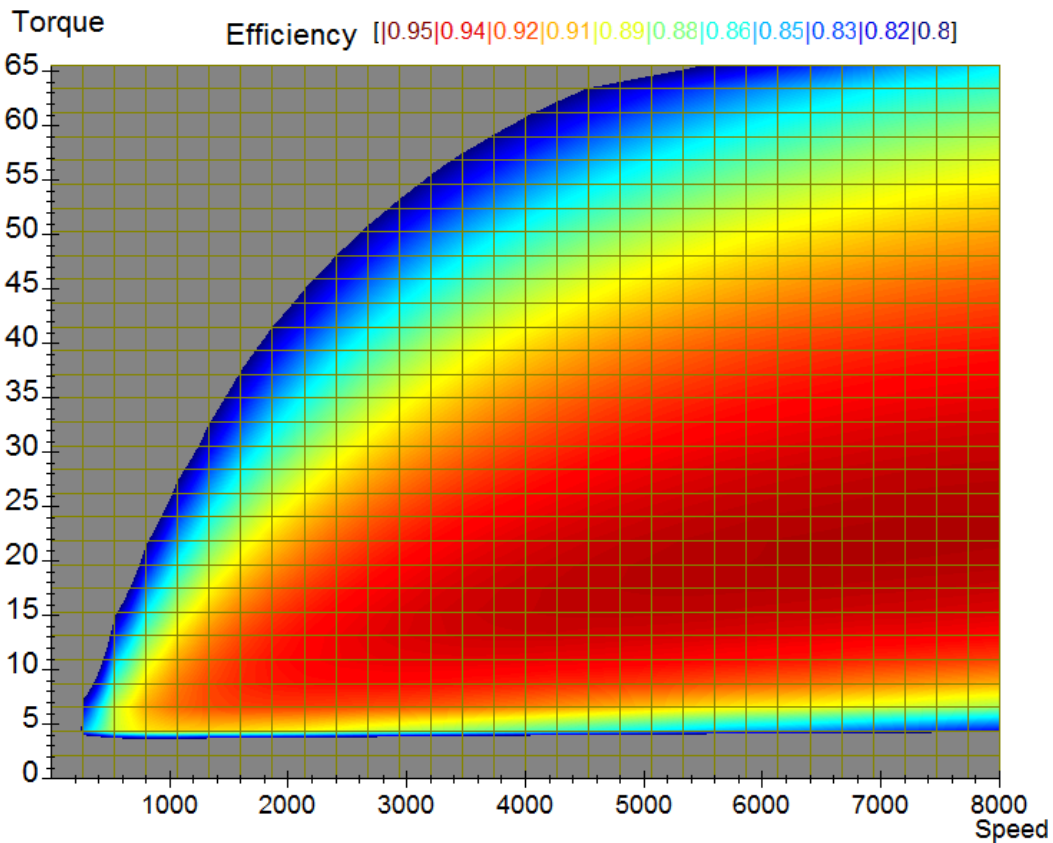

GVM142-100 in Motor operation mode :

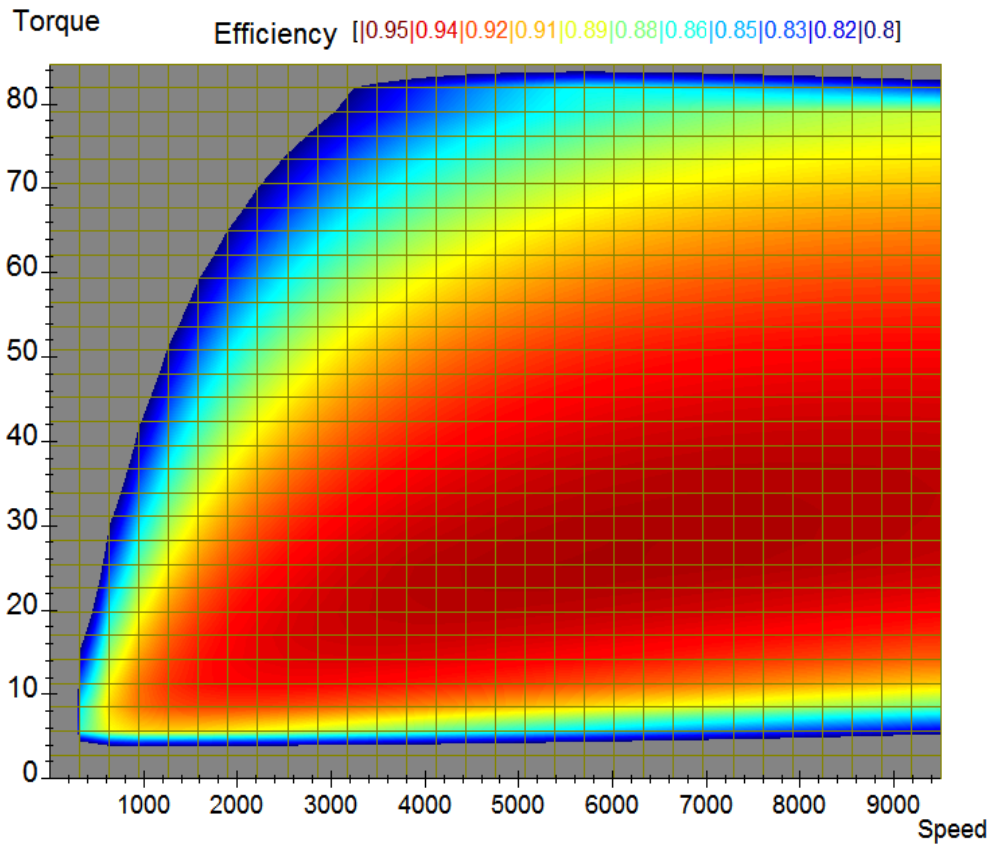

GVM142-100 in Generator operation mode :

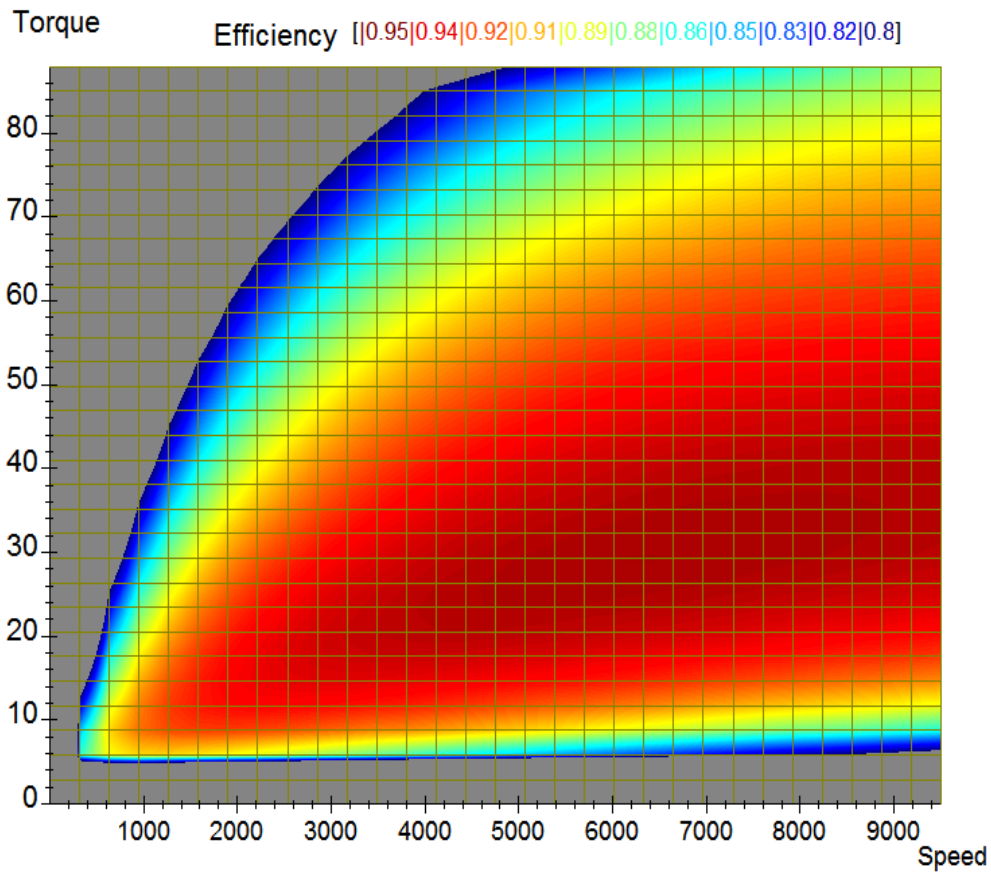



GVM210-050 in Motor operation mode :

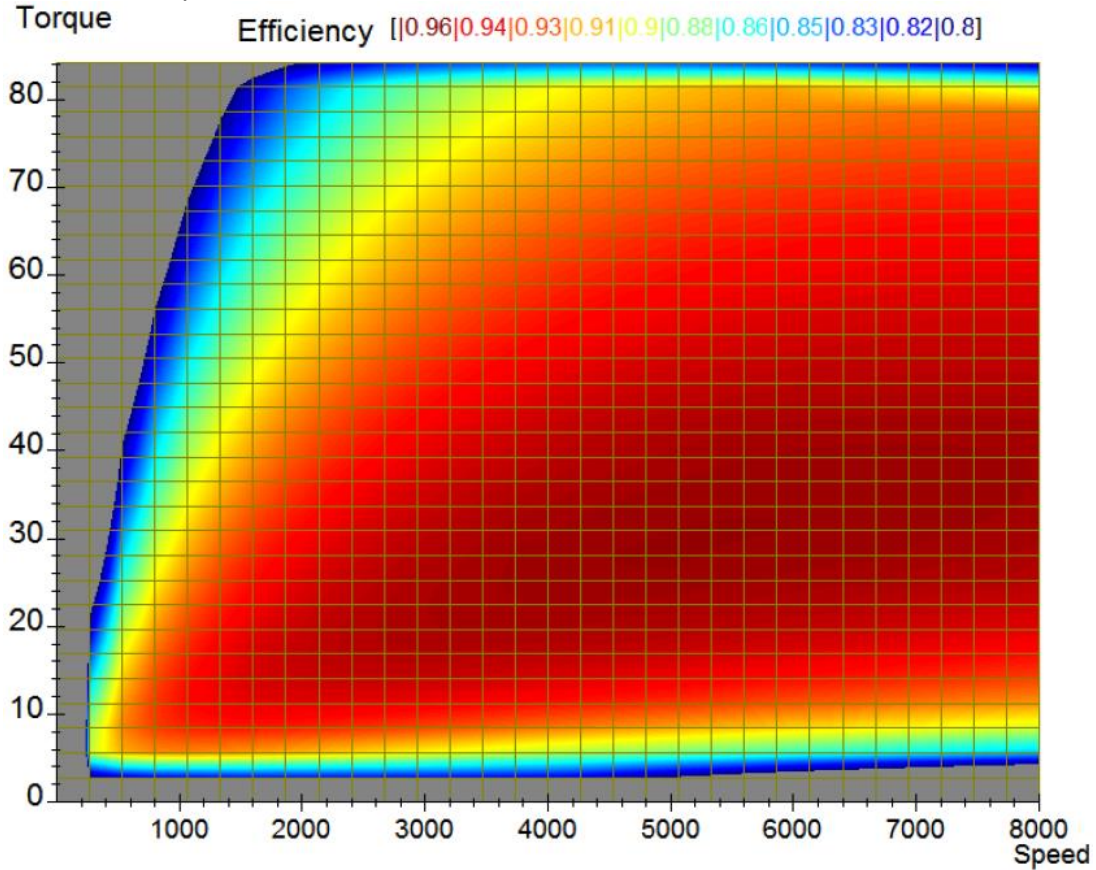

GVM210-050 in Generator operation mode :

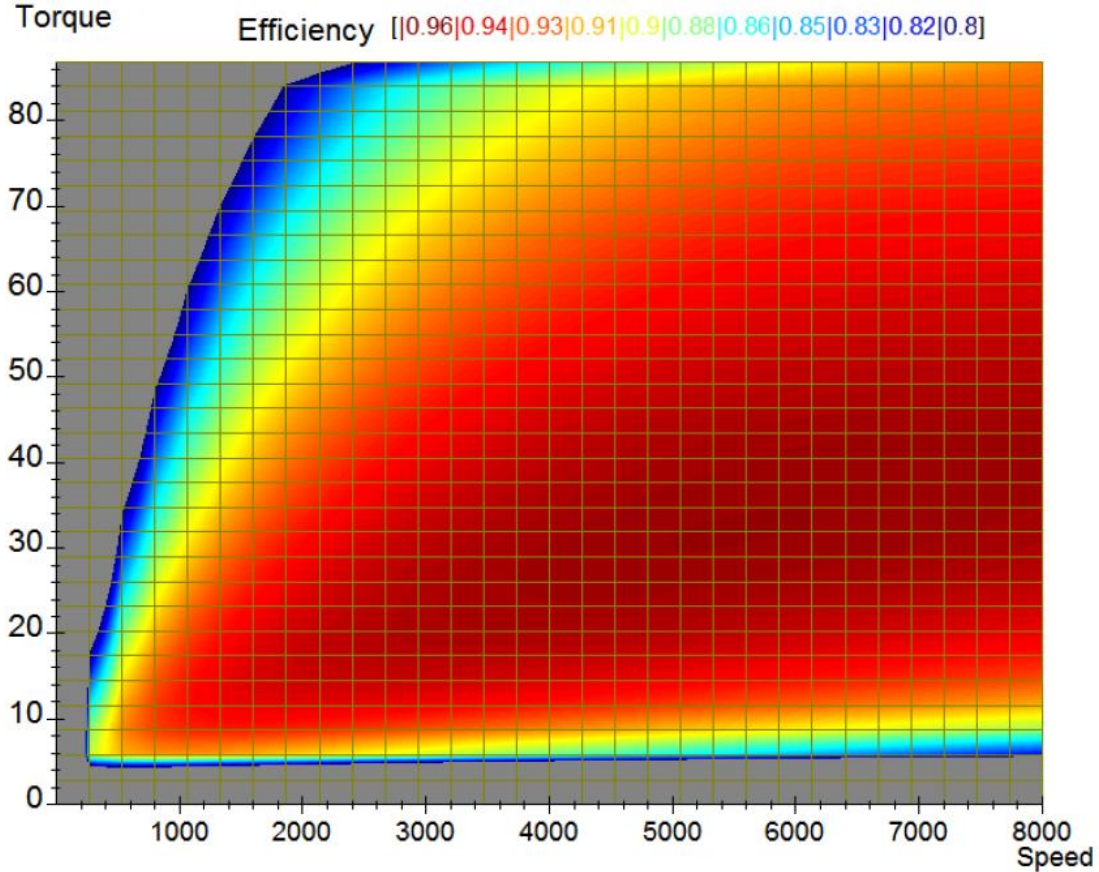

GVM210-100 in Motor operation mode :



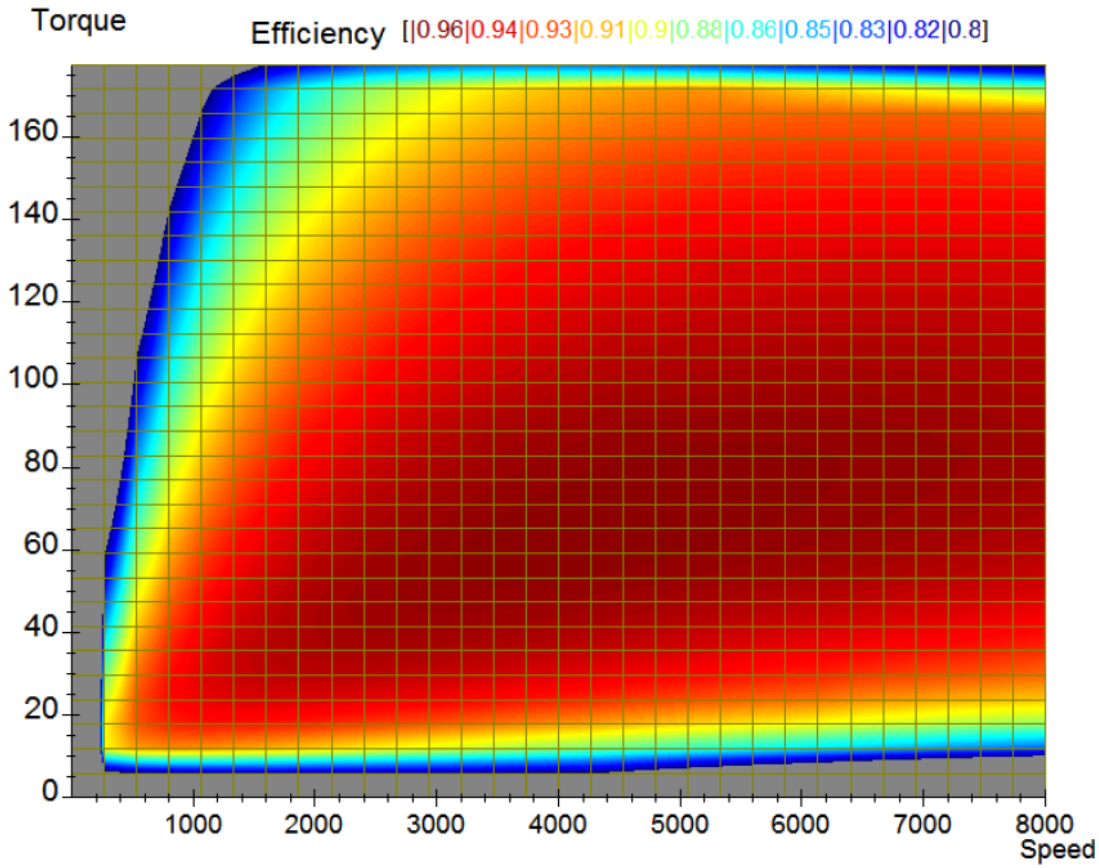

GVM210-100 in Generator operation mode :

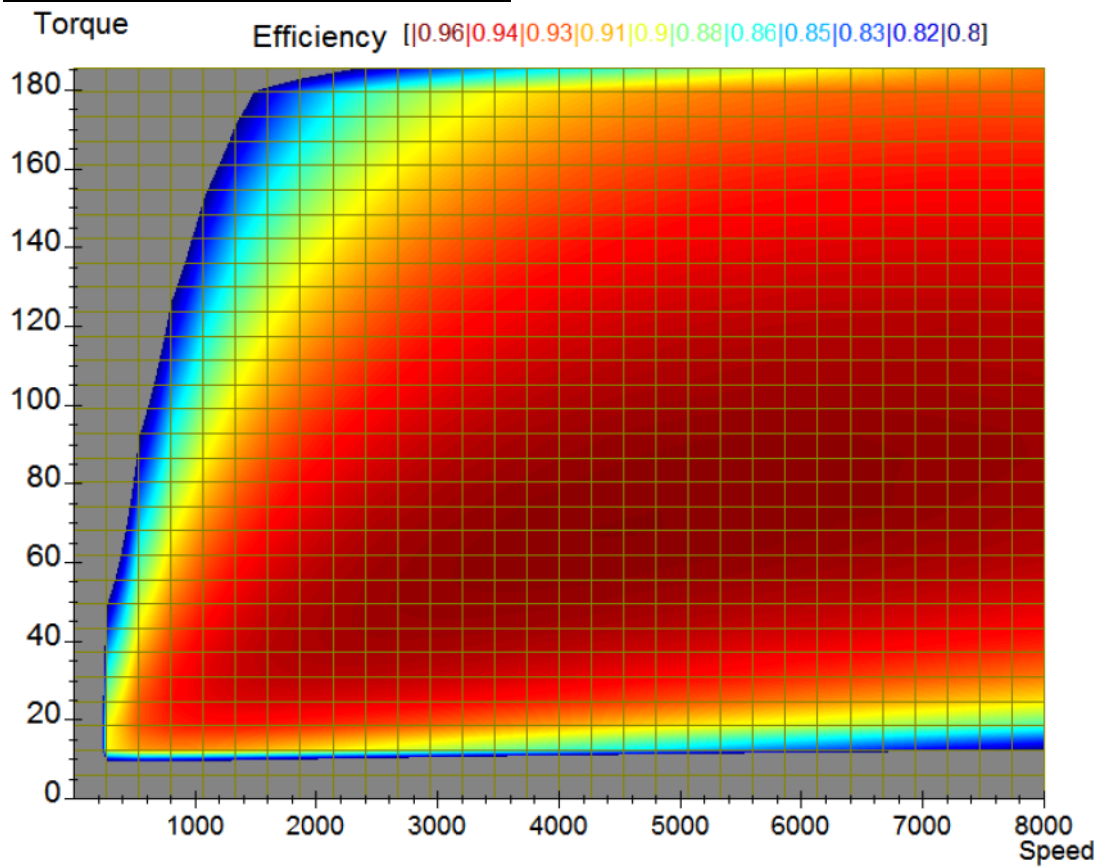

GVM210-150 in Motor operation mode :

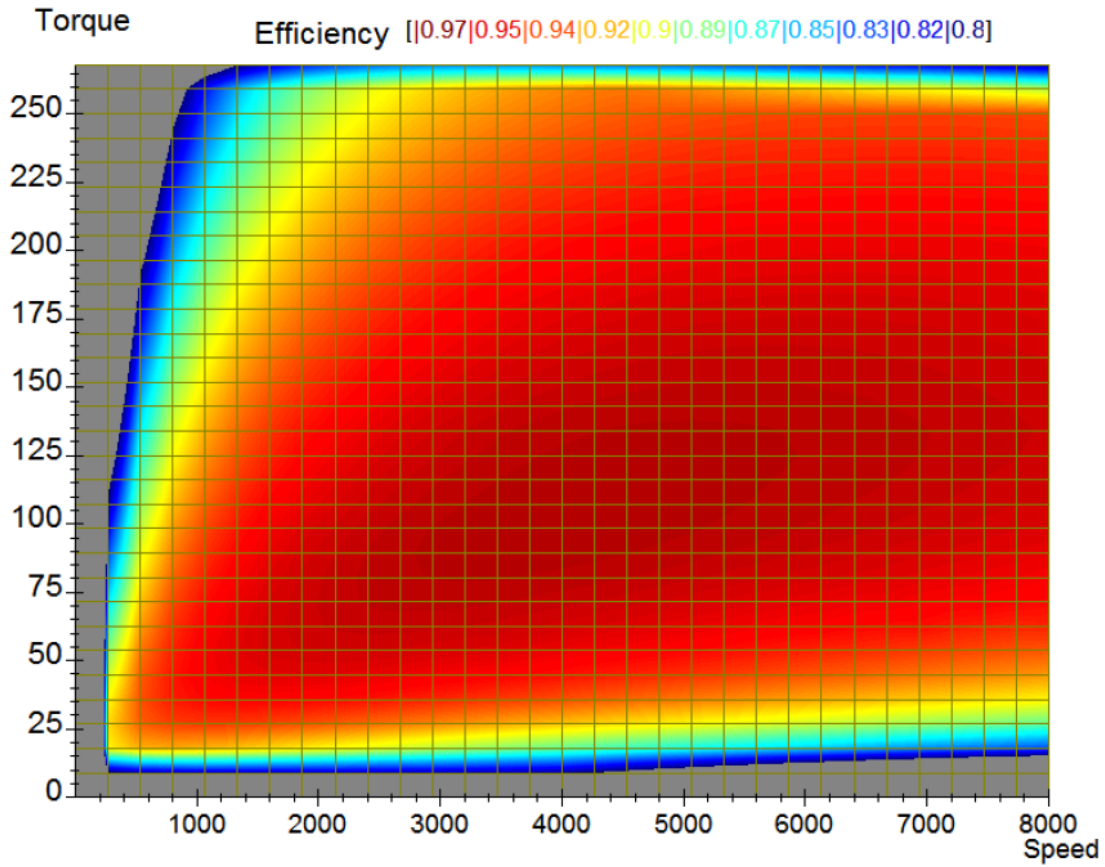

GVM210-150 in Generator operation mode :

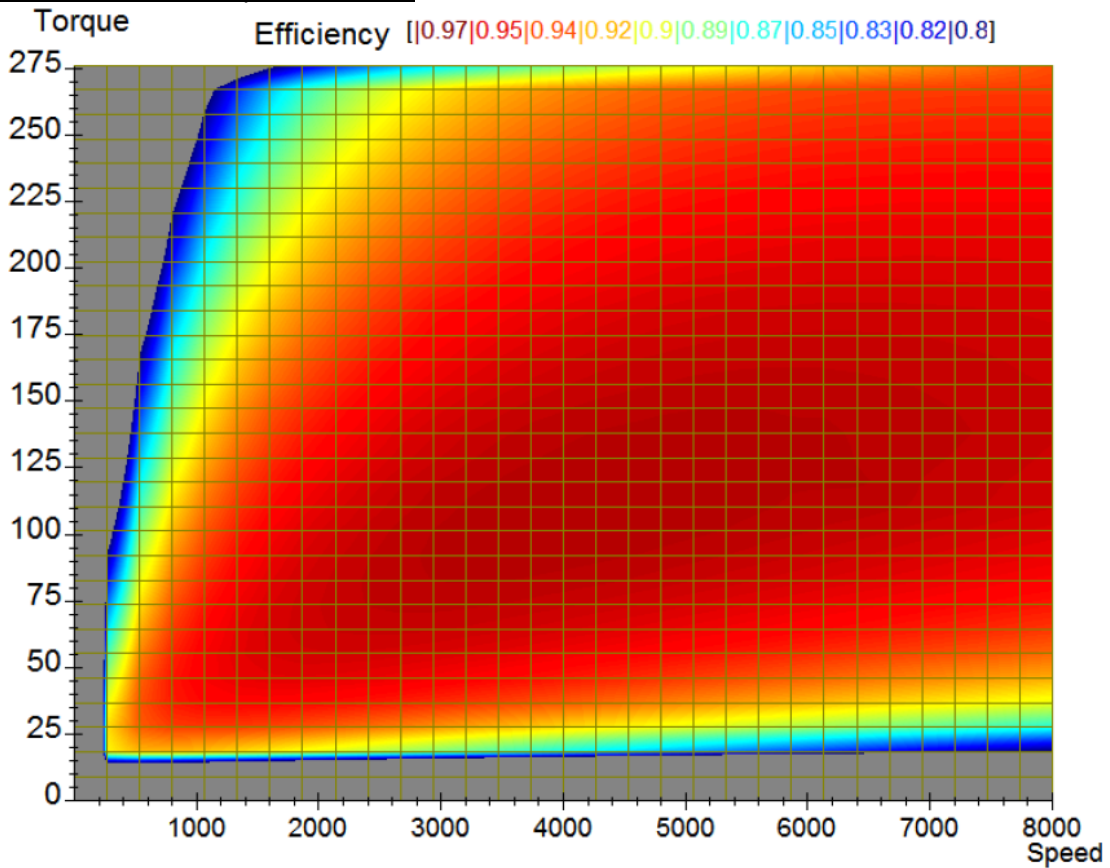



GVM210-200 in Motor operation mode :

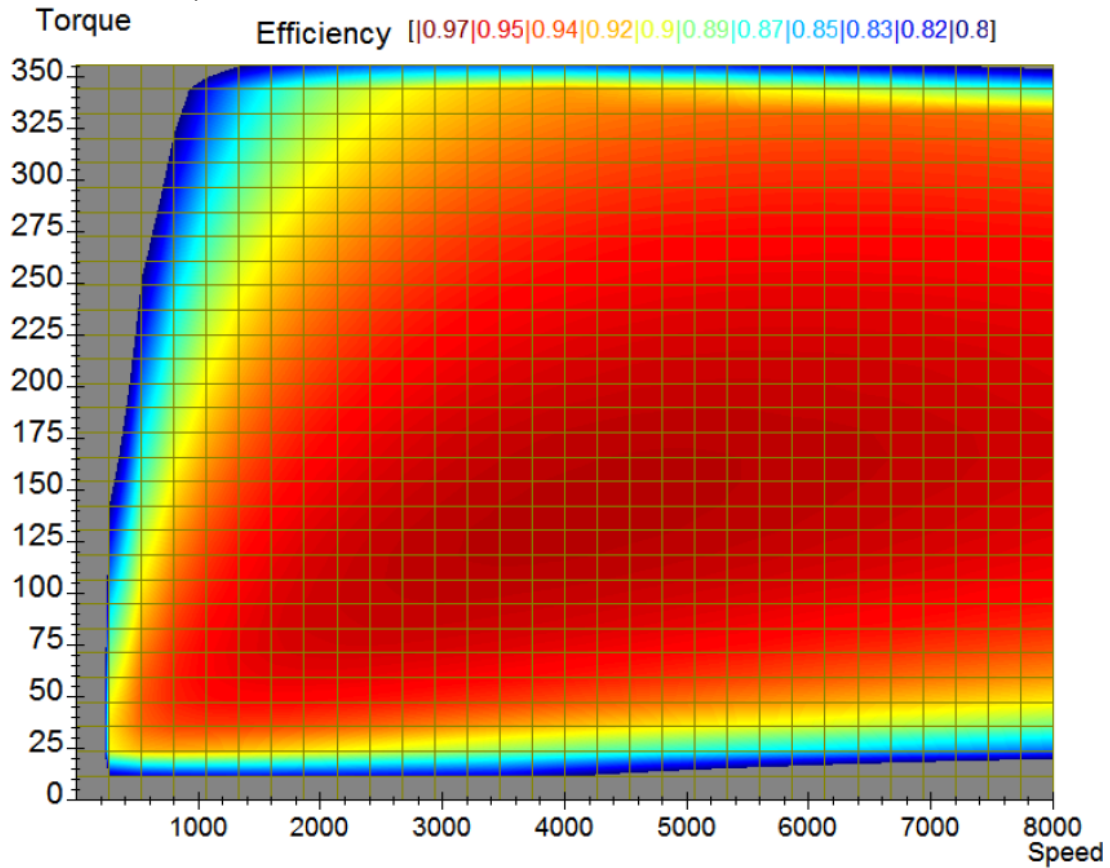

GVM210-200 in Generator operation mode :

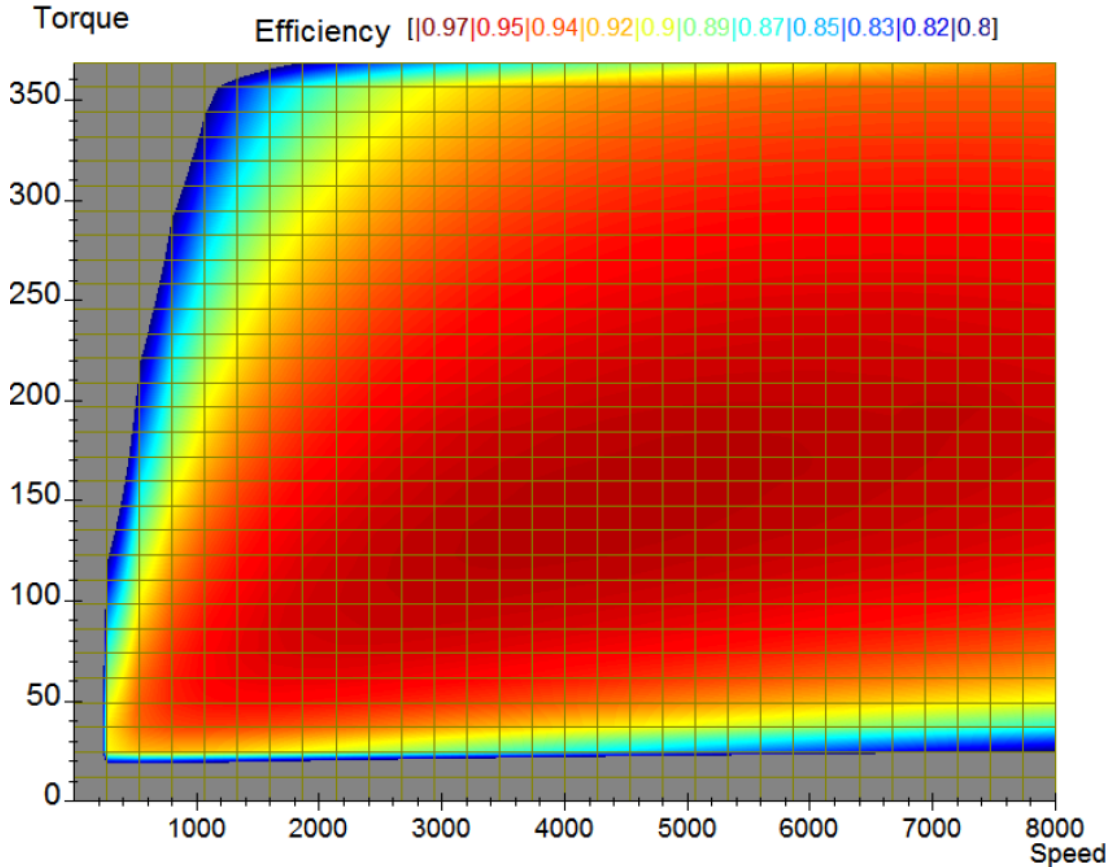





GVM210-300 in Motor operation mode :

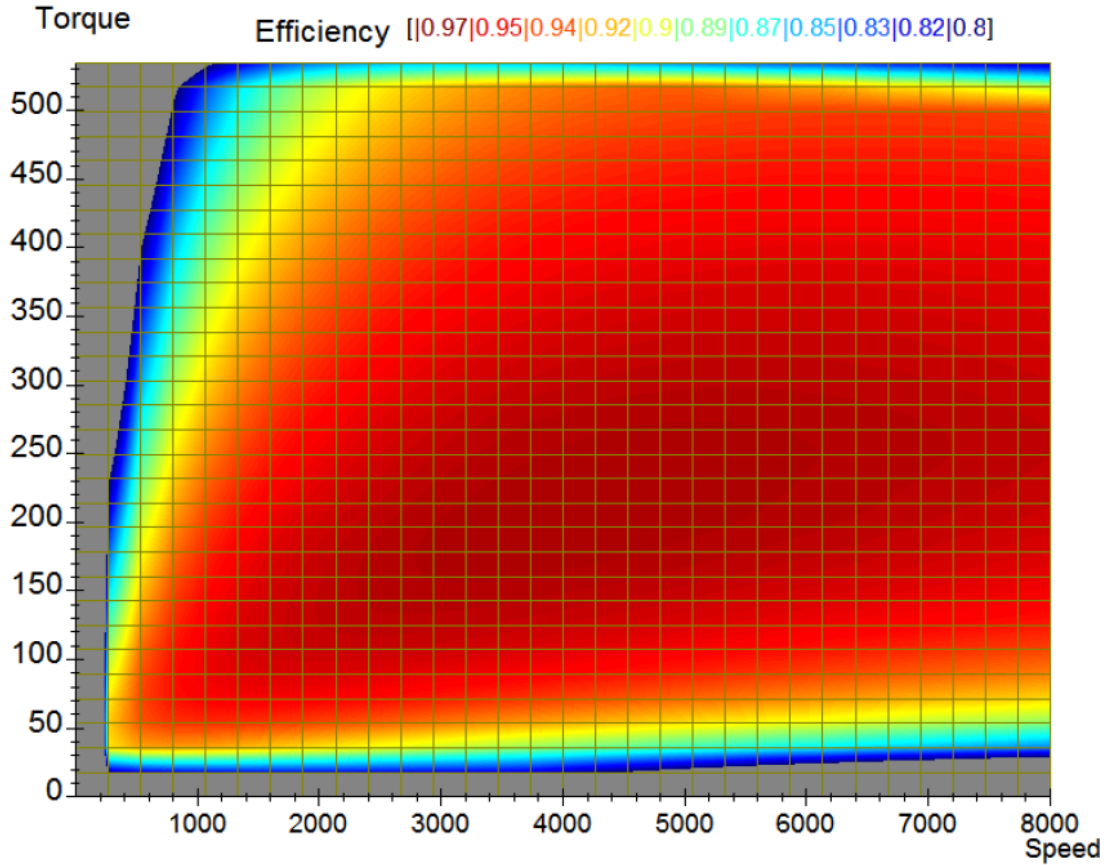

GVM210-300 in Generator operation mode :

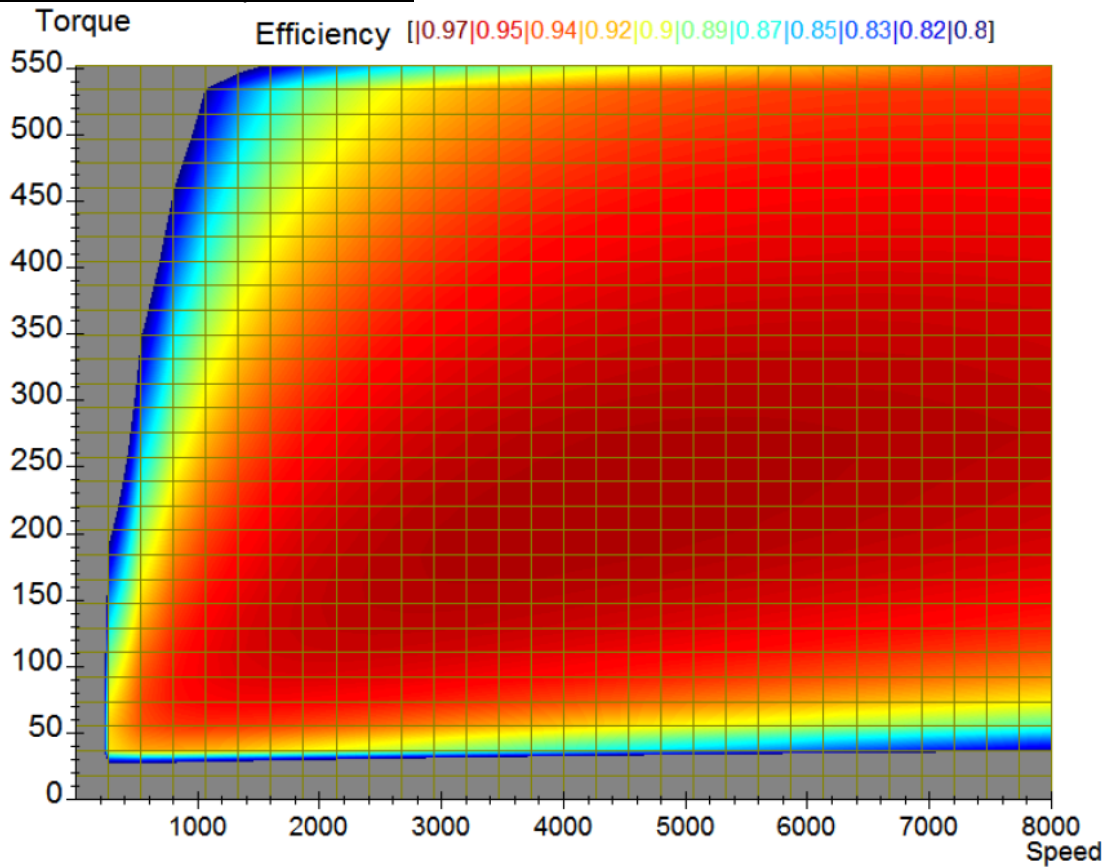



GVM210-400 in Motor operation mode :

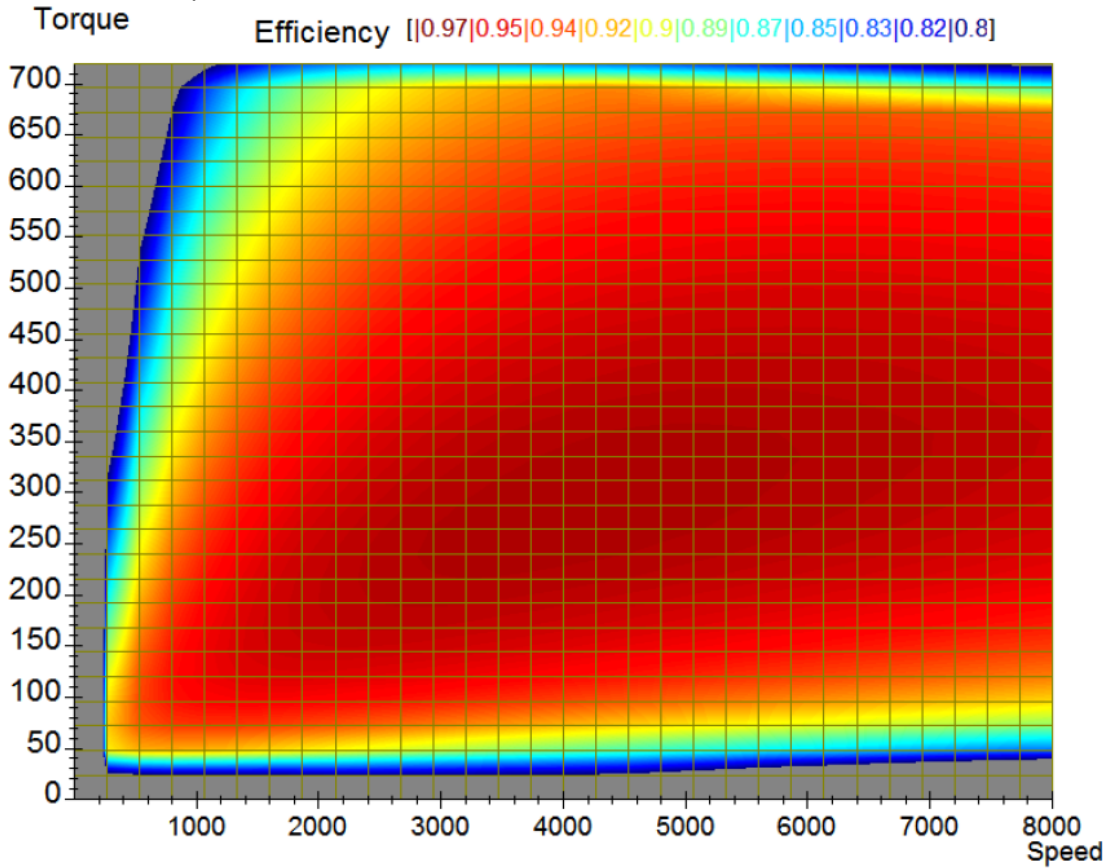

GVM210-400 in Generator operation mode :

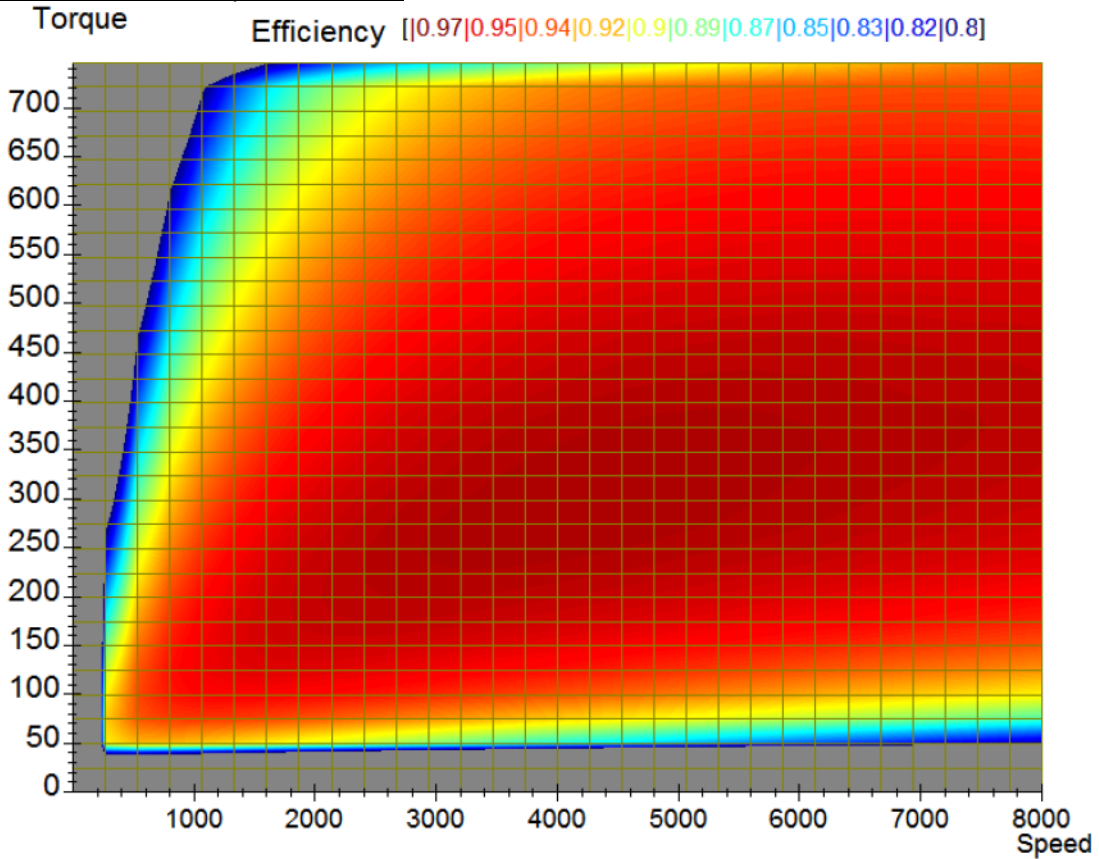

### 3.2.2. Time constants of the motor

#### 3.2.2.1. Electric time constant:

$$\tau_{elec} = \frac{L_{ph\_ph}}{R_{ph\_ph}}$$

With following values given in the motor data sheet  
 $L_{ph\_ph}$  inductance of the motor phase to phase [H],  
 $R_{ph\_ph}$  resistance of the motor phase to phase at 25°C [Ohm].

#### Example:

Motor series GVM210-400-DPW

$L_{ph\_ph} = 0.316$  mH or  $3.16E-4$  H

$R_{ph\_ph}$  at 25°C = 0.15 Ohm

→  $\tau_{elec} = 3.16E-4/0.15 = 21$  ms

An overall summary of motor time constants is given later.

#### 3.2.2.2. Mechanical time constant:

$$\tau_{mech} = \frac{R_{ph\_ph} * J}{Kt * Ke_{ph\_ph}} = \frac{0.5 * R_{ph\_ph} * J}{(3 * \frac{Ke_{ph\_ph}}{\sqrt{3}}) * \frac{Ke_{ph\_ph}}{\sqrt{3}}}$$

$$\tau_{mech} = \frac{0.5 * R_{ph\_ph} * J}{(Ke_{ph\_ph})^2}$$

With following values obtained from the motor data sheet:

$R_{ph\_ph}$  resistance of the motor phase to phase at 25°C [Ohm],

$J$  inertia of the rotor [kgm<sup>2</sup>],

$Ke_{ph\_ph}$  back emf phase coefficient phase to phase [V<sub>rms</sub>/rad/s].

The coefficient  $Ke_{ph\_ph}$  in the formula above is given in [V<sub>rms</sub>/rad/s]

To calculate this coefficient from the datasheet, use the following relation:

$$Ke_{ph\_ph} [V_{rms}/rad/s] = \frac{Ke_{ph\_ph} [V_{rms}/1000rpm]}{\frac{2 * \pi * 1000}{60}}$$

#### Example:

Motor series GVM210-400-DPW

$R_{ph\_ph}$  at 25°C = 0.015 Ohm

$J = 0.07$  kgm<sup>2</sup>

$Ke_{ph\_ph} [V_{rms}/1000rpm] = 76.9$  [V<sub>rms</sub>/1000rpm]

→  $Ke_{ph\_ph} [V_{rms}/rad/s] = 76.9 / (2 * \pi * 1000 / 60) = 0.734$  [V<sub>rms</sub>/rad/s]

→  $\tau_{mech} = 0.5 * 0.015 * 0.07 / (0.734^2) = 0.97$  ms

#### Remarks:



For a GVM motor, the mechanical time constant  $\sigma_{mech}$  represents the duration needed to reach 63% of the final speed when applying a voltage step without any resistant torque, if the electrical time constant is much smaller than the mechanical time constant.

An overall summary of motor time constants is given later.

### 3.2.2.3. Thermal time constant of the copper:

$$\tau_{therm} = Rth_{copper\_ambient} * Cth_{copper}$$

$$Cth_{copper[J/^{\circ}K]} = Mass_{copper[Kg]} * 389_{[J/kg^{\circ}K]}$$

With:

**$Rth_{copper\_ambient}$**  thermal resistance between copper and ambient [ $^{\circ}K/W$ ]

**$Cth_{copper}$**  thermal capacity of the copper [ $J/^{\circ}K$ ]

**$Mass_{copper}$**  mass of the copper (winding) [kg]

Overall summary of motor time constants:

Type	Electric time constant (ms)	Mechanical time constant (ms)	Thermal time constant of copper (s)
GVM142-050	6.5	1.80	24.4
GVM142-075	7.3	1.58	21.6
GVM142-100	8.0	1.37	20.3
GVM210-050	12	1.87	66
GVM210-100	16	1.29	50
GVM210-150	18	1.15	45
GVM210-200	19	1.09	43
GVM210-300	20	1.01	40
GVM210-400	21	0.97	39







### 3.3.2. GVM210 outline drawings

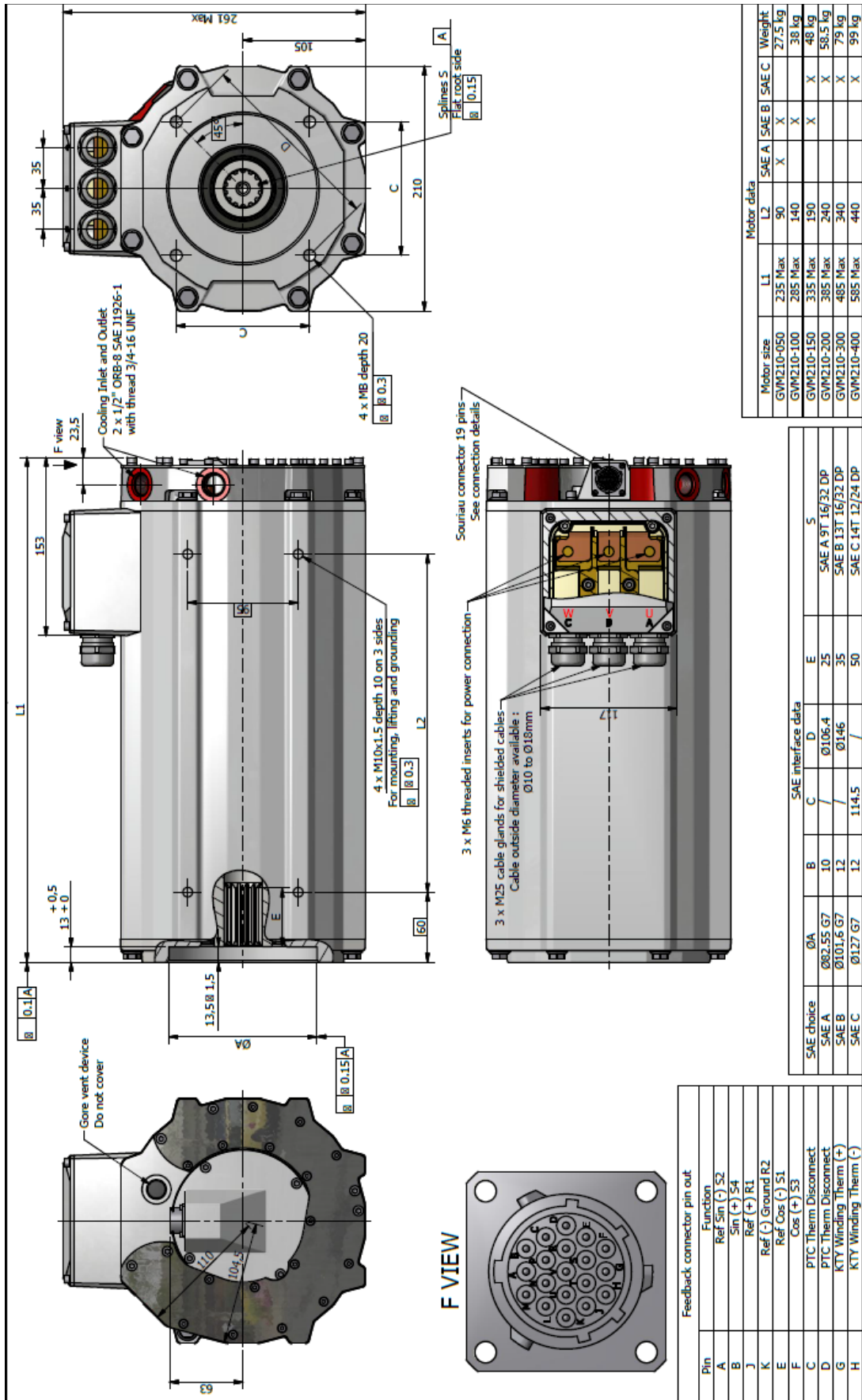





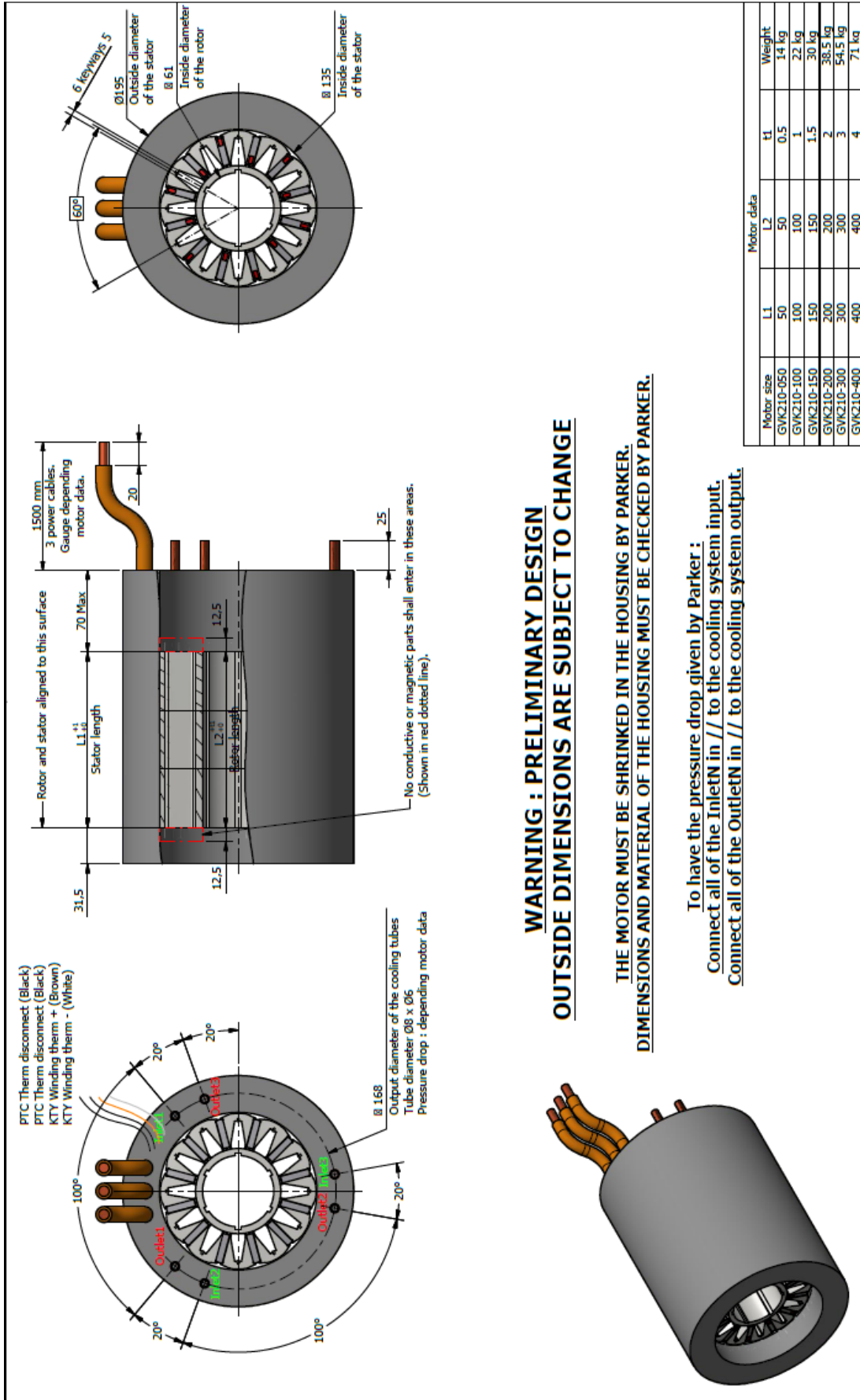

**WARNING : PRELIMINARY DESIGN  
 OUTSIDE DIMENSIONS ARE SUBJECT TO CHANGE**

**THE MOTOR MUST BE SHRINKED IN THE HOUSING BY PARKER.  
 DIMENSIONS AND MATERIAL OF THE HOUSING MUST BE CHECKED BY PARKER.**

To have the pressure drop given by Parker :  
 Connect all of the InletN in // to the cooling system input.  
 Connect all of the OutletN in // to the cooling system output.

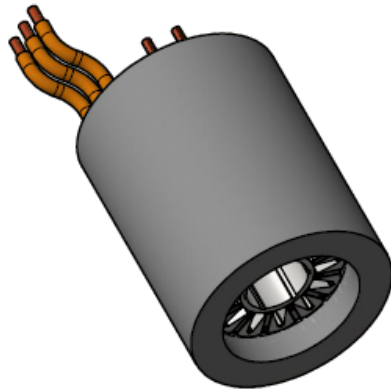

Motor size	Motor data				Weight
	L1	L2	t1	t2	
GWK210-050	50	50	0.5	1	14 kg
GWK210-100	100	100	1	1.5	22 kg
GWK210-150	150	150	2	2	30 kg
GWK210-200	200	200	3	3	38.5 kg
GWK210-300	300	300	4	4	54.5 kg
GWK210-400	400	400	4	4	71 kg

### 3.4. Motor mounting

#### 3.4.1. Motor mounting environment

Ideally mount motors:

In a location away from, or shielded from other vehicle heat sources such as exhaust, or catalytic converters etc.

In a location that will benefit from air flow while the vehicle is in motion.

In location that is protected from flying rocks, debris, road salt, or other contaminants that could damage cabling and connections.

#### 3.4.2. Motor mounting

For the screws tightening torque values, please see the board on page 61.

Traction mounting :

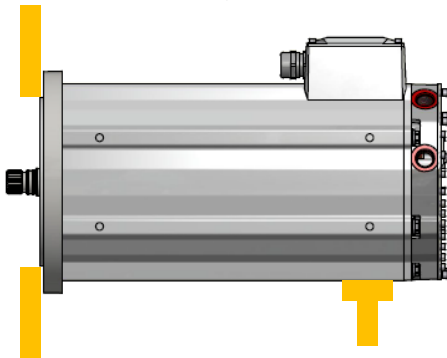

EHP mounting :

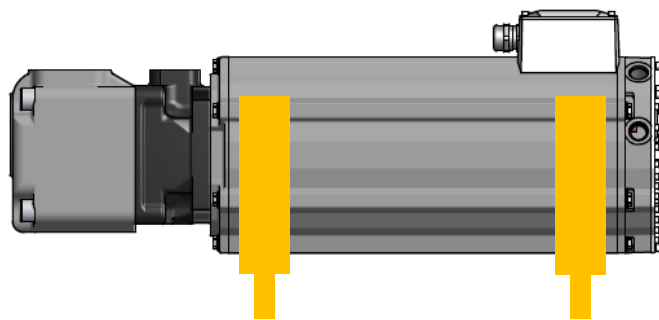

GVM motors have been designed for an horizontal mounting (see §4.2.2). For alternative mounting positions, please contact Parker.



GVM motors have been designed for being assembled on gearboxes or hydraulic pumps and cannot support any axial / radial additional load on the shaft.

#### Mounting recommendation step by step:

- The mounting surfaces of the interfaces should be free from bumps and scratches, washed and lubricated with grease as detailed below before mounting.
- The coupling spline must be lubricated with a lithium molydisulfide grease, disulfide of molybdenum or similar lubricant.
- The mating motor spline should be free to float and find its own center:
  - Set up the equipment on the motor.
  - Set up the equipment assembling screws, but do not tighten.
  - Rotate the motor between 1000 and 1500 rpm and gradually tighten the screws.
  - Torque the mounting screws of the equipment at the nominal torque.

### 3.4.3. Frame recommendation

	<p><u>Warning</u> : The user has the entire responsibility to design and prepare the support, the coupling device, shaft line alignment, and shaft line balancing.</p>
---	--

Frame supporting the GVM must be even, sufficiently rigid and shall be dimensioned in order to avoid vibrations due to resonances.

### 3.4.4. Pulley/belt

	<p><u>Warning</u> : The GVM motors are not designed to operate with pulley / belt systems. By limiting the speed and/or using specific bearing assemblies, it can be possible in some cases to use pulley / belt systems. It is mandatory to raise a request with the factory before doing so.</p>
---	--



## 3.5. Bearings

The bearings are greased for life.

The standard bearing life is calculated to reach 20.000h at maximum speed (GVM142 : 9800 rpm ; GVM210 : 8000rpm) without load.





It is recommended to change it once the predicted lifetime is reached.

Please contact Parker in order to achieve this operation.

	<p>Other limitations can come from the winding or the drive (cf: §3.1.4-Drive selection)</p>
	<p>The bearing arrangement is made with 2 ball bearings (one on the shaft end + another on the rear). The rear bearing is blocked in axial translation and the front one is free in translation to avoid any stress from the shaft thermal expansion during the running. So, it is important not to block in translation the shaft expansion by any extra bearing or similar device.</p>

## 3.6. Cooling

### 3.6.1. General recommendations

	<p><u>Danger:</u> It is compulsory to start the cooling system before starting the motor.</p>
	<p><u>Danger:</u> The Inlet temperature and the water flow have to be monitored to avoid any damage.</p>
	<p><u>Caution:</u> When motor is no more running, the cooling system has to be stopped 10 minutes after the motor shut down.</p>
	<p><u>Danger:</u> If the water flow stops, the motor can be damaged or destroyed causing accidents.</p>
	<p><u>Danger:</u> For the oil cooling system, a pre-heating at 40°C is recommended before starting the motor.</p>

### 3.6.2. Additives for water as cooling media

Please refer to motor technical data for coolant flow rates.

The inner pressure of the cooling liquid must not exceed **5 bars**.

	<p><u>Caution:</u> To avoid the corrosion of the motor cooling system (aluminum or copper), the water must have anti-corrosion additive.</p>
---	--

The GVM motors can be water or oil cooled. Corrosion inhibitors must be added to the water to avoid the corrosion. The complete cooling system must be considered to choose the right additive, this includes: the different materials in the cooling circuit, the chiller manufacturer recommendations, the quality of the water...

The right additive solution is the responsibility of the user. Some additives like TYFOCOR or GLYSANTIN G48 correctly used have demonstrated their ability to prevent corrosion in a closed cooling circuit

For example: Glysantin G48 recommendations are :

- Water hardness: 0 to 20°dH (0 – 3.6 mmol/l)
- Chloride content: max. 100ppm
- Sulphate content: max. 100ppm

	<p><u>Caution:</u> The water quality is very important and must comply with supplier recommendations. The additive quantity and periodic replacement must respect the same supplier recommendations.</p>
---	--

	<p><u>Caution:</u> The additive choice must take into account the complete cooling system (chiller or water exchanger recommendations...).</p>
---	--

	<p>Select carefully the materials of all the cooling system parts (chiller, exchanger, hoses, adapters and fittings) because the difference between material galvanic potential can generate corrosion.</p>
---	---

### 3.6.3. Flow rating according to glycol concentration

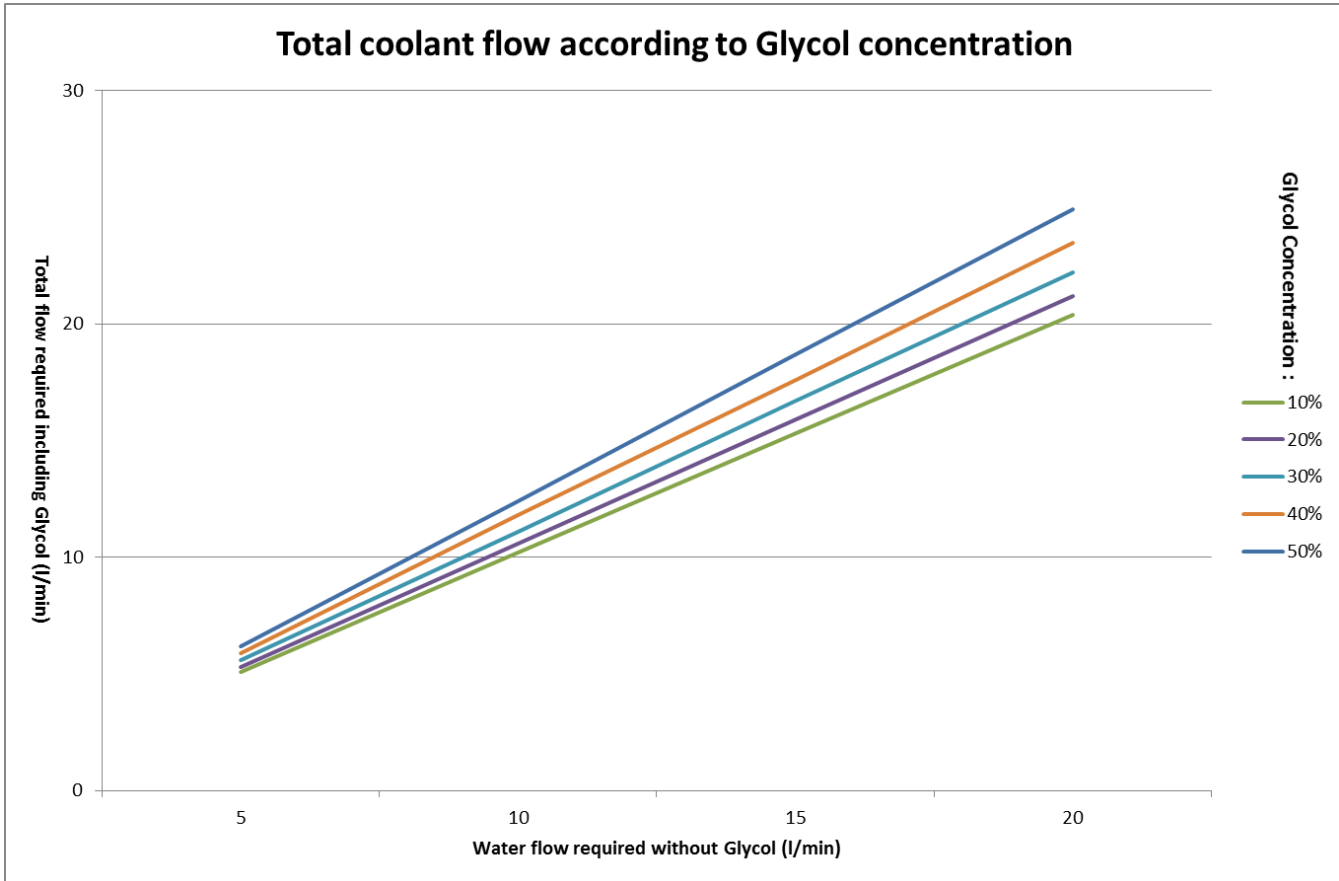

#### Use of the graph above - Example

If the motor needs 10 l/min with 0% glycol,  
 If application needs 20% glycol, the water flow must be 10,6 l/min,  
 If application needs 40% glycol, the water flow must be 11,8 l/min.

#### Main formulas

$$Flow\_rate = \frac{Power\_dissipation * 60}{\Delta\theta * C_p}$$

With: *Flow rate* [l/min]  
*Power\_dissipation* [W]  
 $\Delta\theta$  Gradient inlet-outlet [°C]  
*Cp* thermal specific capacity of the water as coolant [J/kg°K]  
 (*Cp* depends on the % glycol concentration please see below)

#### Thermal specific capacity Cp according to % glycol concentration and temperature

We have considered an average temperature of the coolant of 30°C.

Glycol concentration [%]	Average temperature of the water as coolant [°C]	Thermal specific capacity of the water Cp [J/kg°K]
0	30	4100
30	30	3700
40	30	3500
50	30	3300

### 3.6.4. GVM Internal Pressure Drop

These values do not take into account the customer cooling connection.

With Water-Glycol 50% - input at 65 °C :

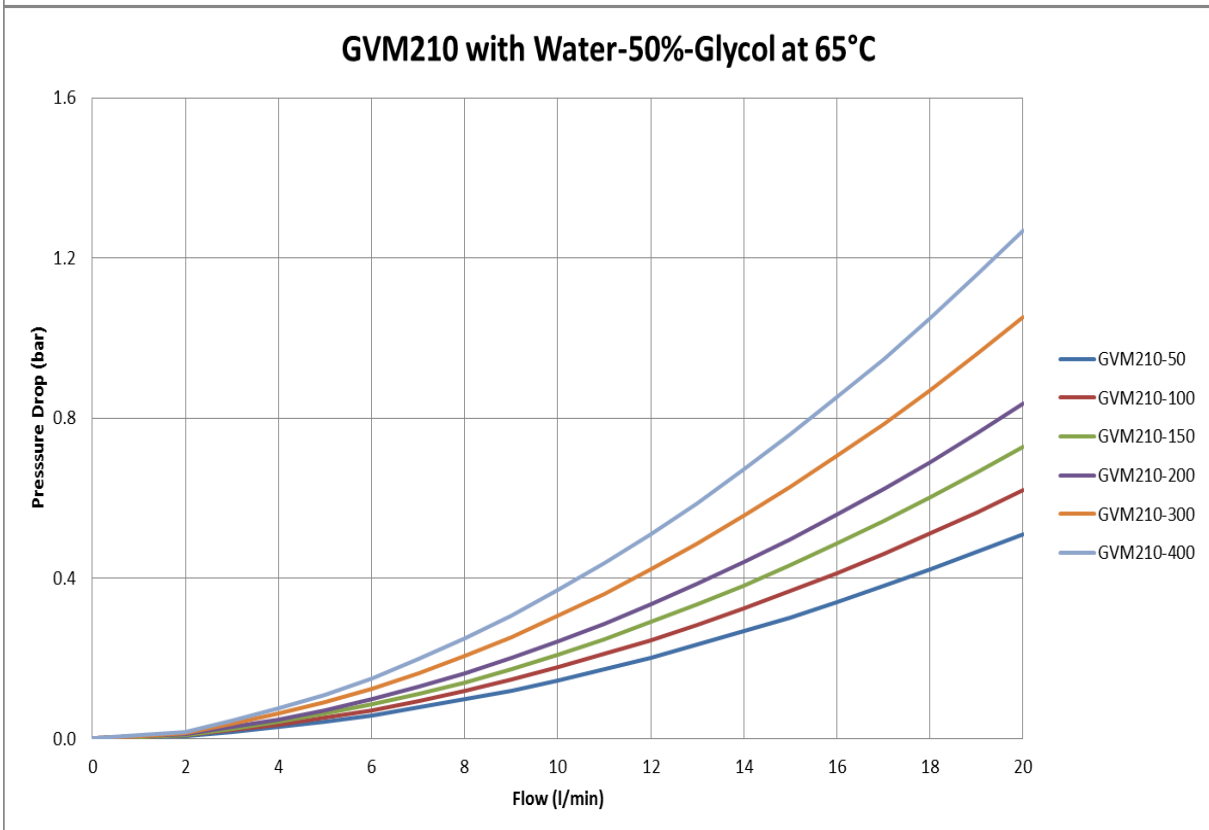
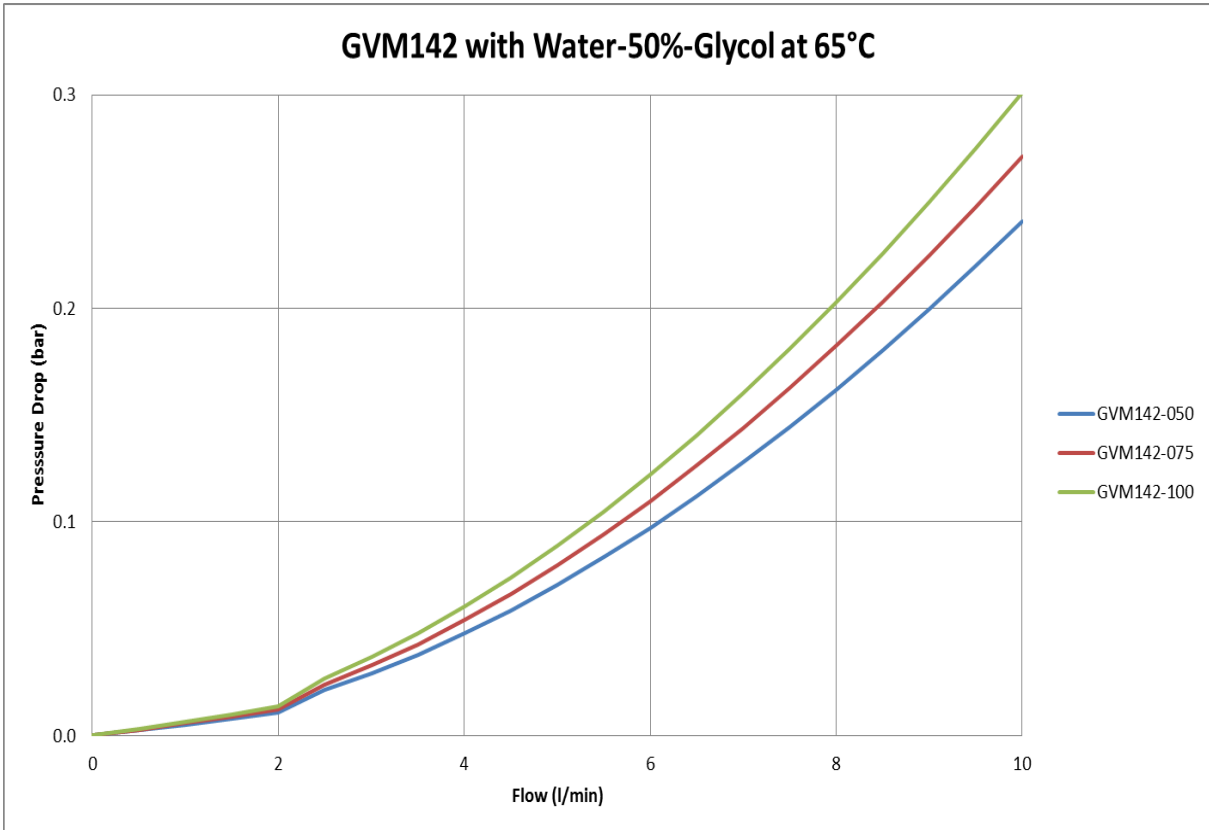



With Oil with a 46 cSt viscosity (@40°C) – input at 65°C :

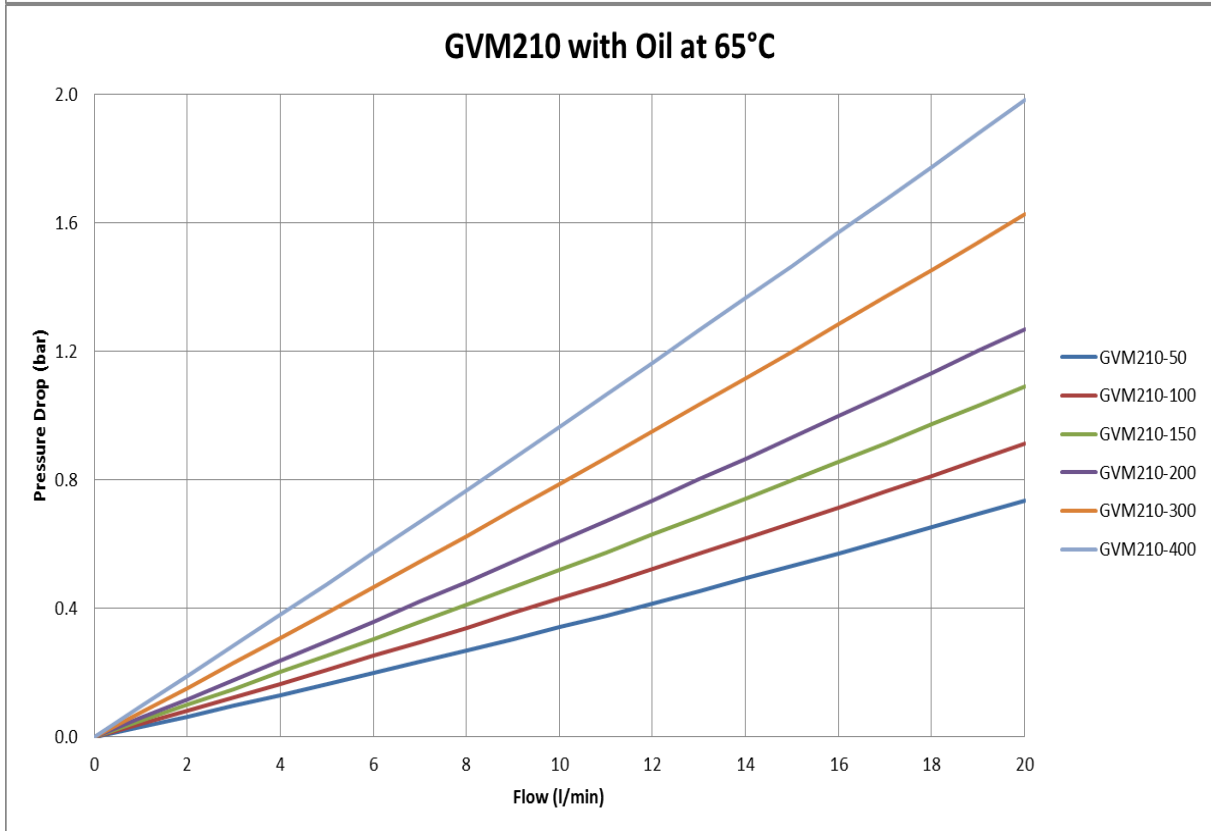
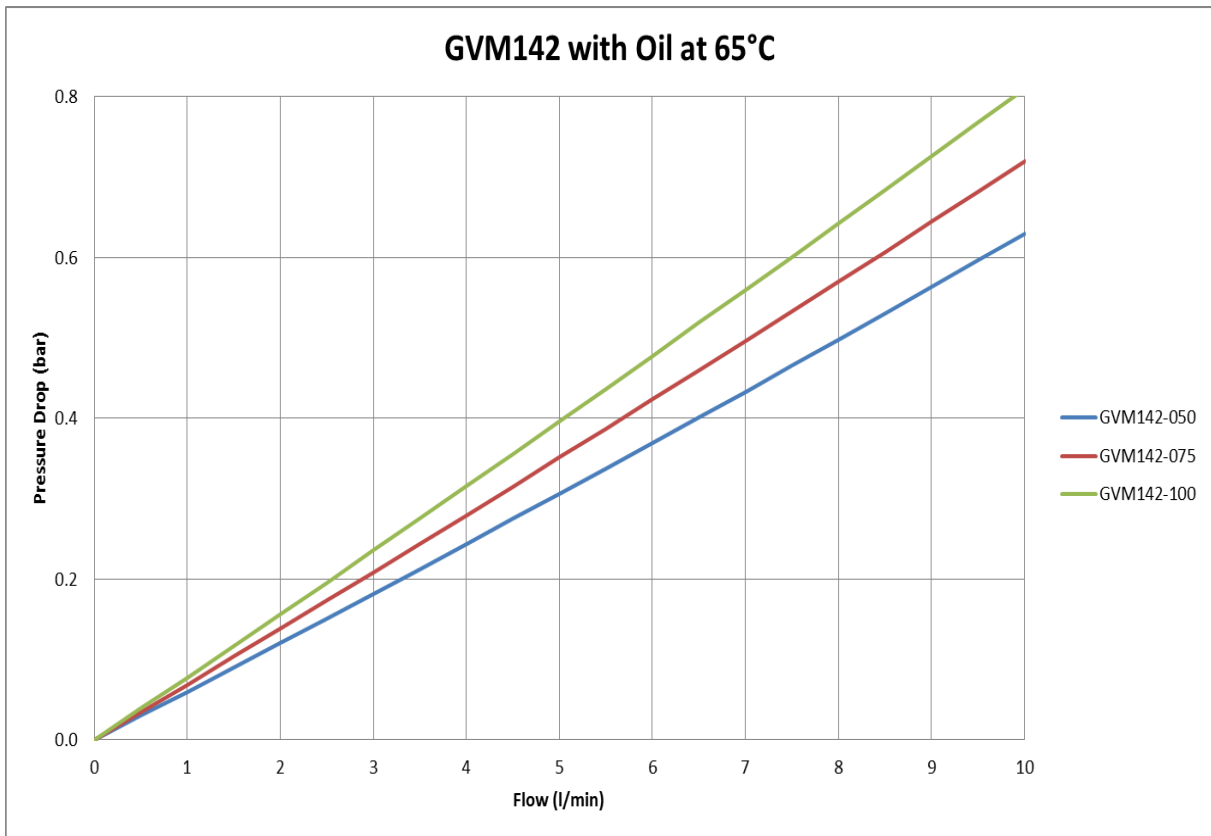





### 3.6.5. Chiller selection

This section describes how to choose the chiller. The chiller is able to extract the heat from the motor losses with the water circulation.

The motor losses (= power to extracted by the chiller) depend on the efficiency and motor power :

$$P_c = \left( \frac{1}{\rho} - 1 \right) P_n$$

With  $P_c$  : Power to evacuate by the chiller (kW)

$P_n$  : Motor rated power (kW)

$\rho$  : Motor efficiency at rated power (%)

Refer to the respective torque motor data sheet for nominal power, efficiency and water flow.

Chiller pump must provide water flow through motor and pipe pressure drop. Inlet temperature must be lower than **65°C**.

#### Example

*Motor : GVM210-050-QQW (see §3.2.1)*

*Rated power = 21.2 kW*

*Efficiency = 95,3%*

*Water flow = 1,51 l/min*

$$P_c = \left( \frac{1}{0,953} - 1 \right) * 21,2 = \mathbf{1,04 \text{ kW}}$$

*So, the chiller must extract 1,04 kW and have a water flow of 1,51 l/min for a GVM210-050-QQW*

### 3.6.6. Liquid cooling diagram



**Recommendation:** The use of a filter allows reducing the presence of impurities or chips in the liquid circuit in order to prevent any obstruction.

This section shows typical liquid cooling diagram:

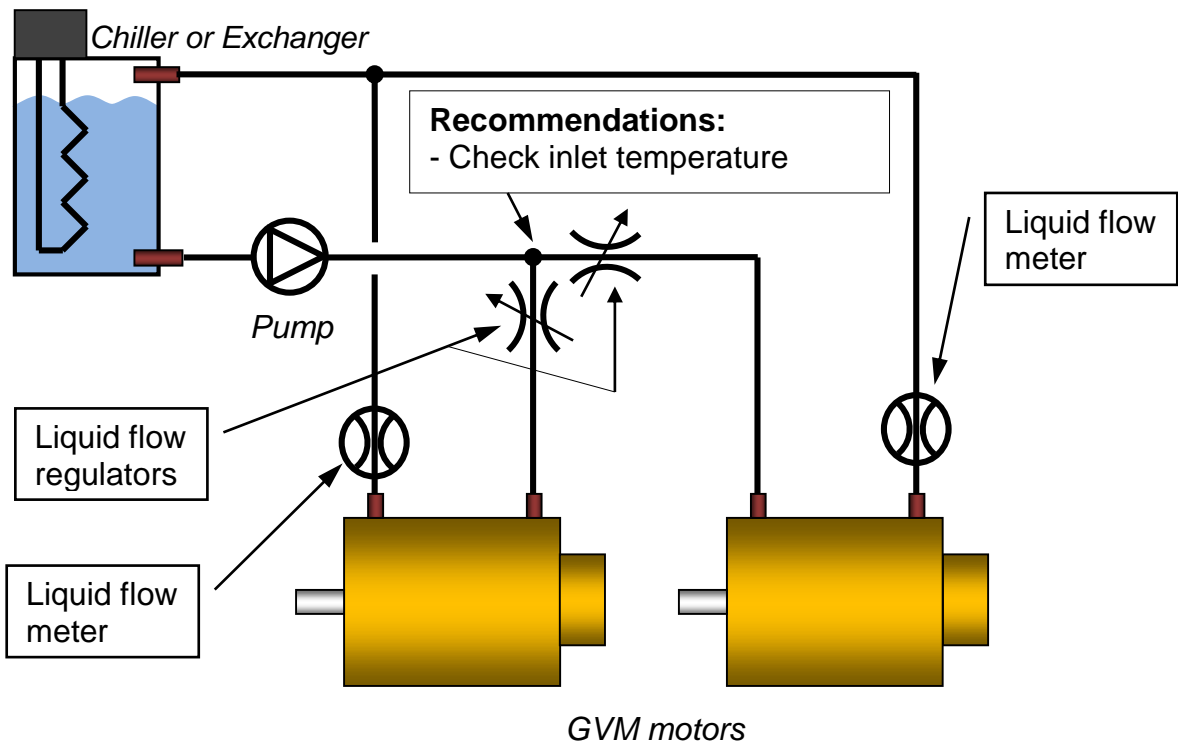
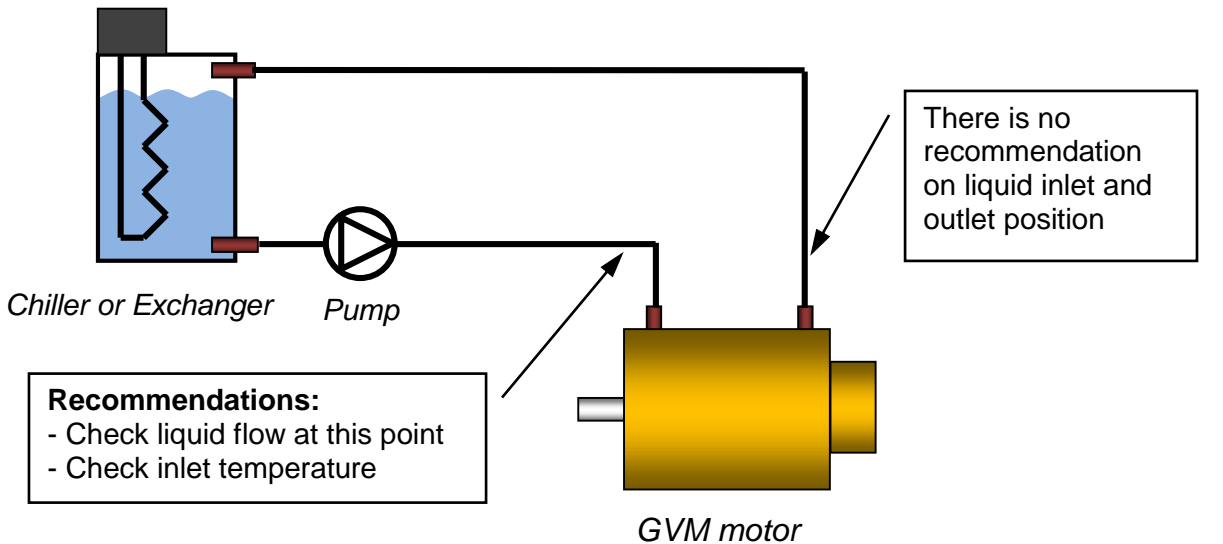

Any other cooling circuit system is fully under customer responsibility.

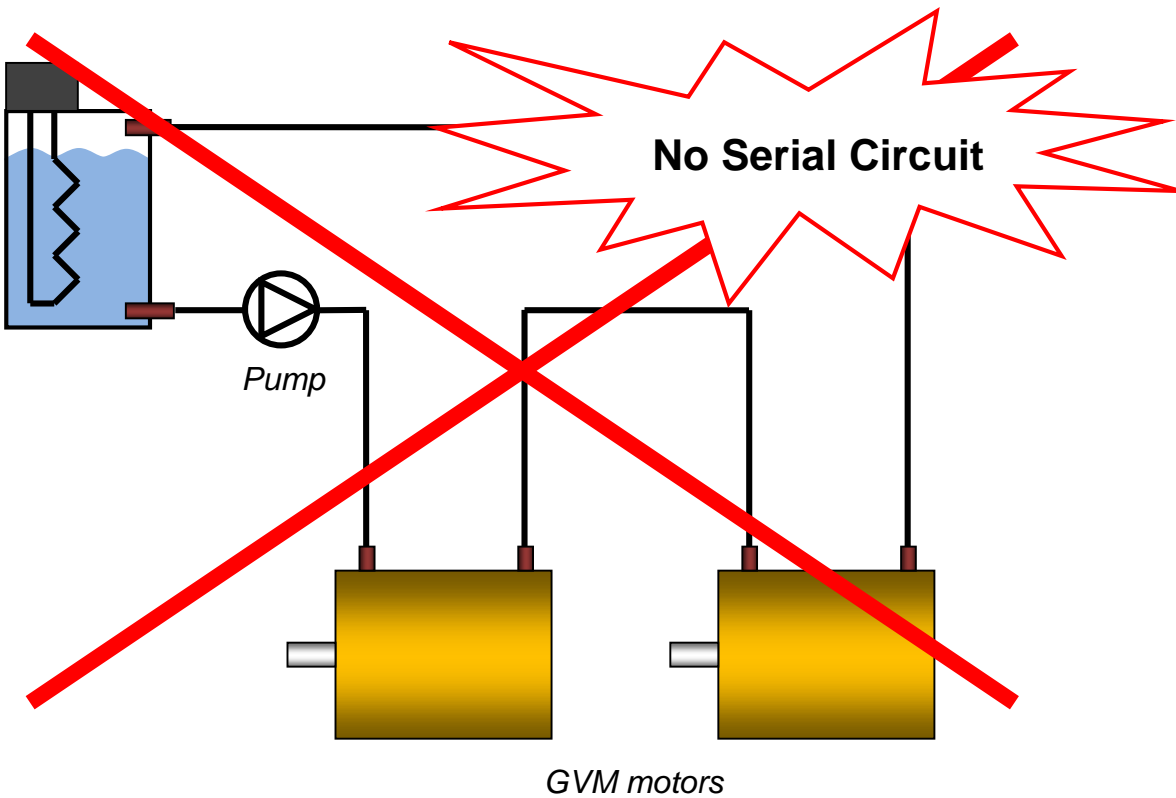
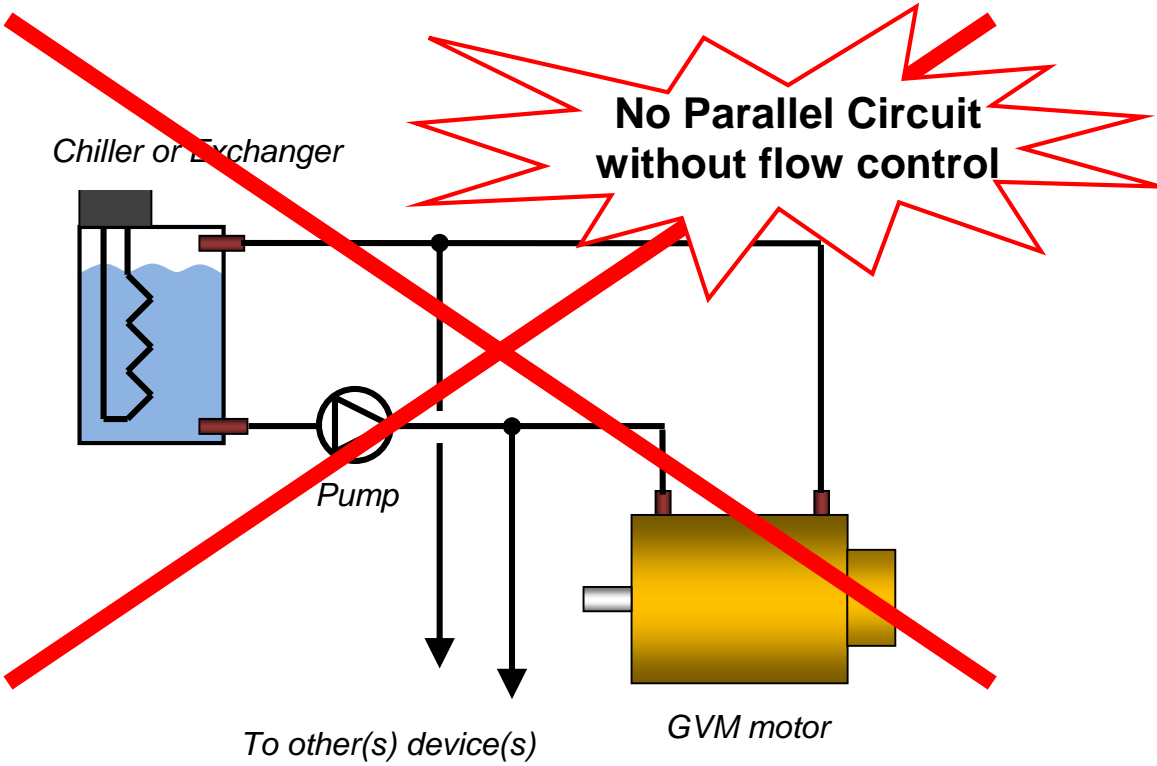

### 3.6.7. Coolant Connections :

GVM142 : Coolant inlet / outlet are ORB-4 SAE J1926-1 with thread 7/16-20 UNF

GVM210 : Coolant inlet / outlet are ORB-8 SAE J1926-1 with thread 3/4-16 UNF

These parts can be provided by Parker as follows :

2 options are available for the GVM fittings :

Male Stud Connector

Male Stud Elbow



GVM142 : 4F50MXS(S)

GVM210 : 8F50MXS(S)

GVM142 : 4C50MXS(S)

GVM210 : 8C50MXS(S)

For hoses and their fittings, we advise to use the following :

Push-Lok Fittings

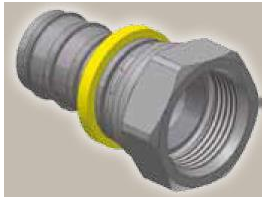

GVM142 : 30682-4-4-SM

GVM210 : 36882-8-8-SM

Push-Lok Hose



With water-glycol or oil up to 85°C :

GVM142 : 801-4-XXX-RL

GVM210 : 801-8-XXX-RL

Where "XXX" stands for  
the hose colour

Assembly Instructions :

1. Cut the hose right angled with a sharp knife. If necessary, it is possible to use a lubricant (water/soap solution with 5% fluid soap and 95% water) for easy assembly.
2. Insert fitting into hose until first barb is in hose. Place end of fitting against a flat object and grip hose approximately 2cm from end and push with a steady force until end of hose is covered by yellow plastic collar.

### 3.7. Thermal Protection

Protection against thermal overloading of the motor is provided by three PTC thermistors and two KTY temperature sensor (one is a redundant spare) built into the stator winding as standard. The thermal sensors, due to their thermal inertia, are unable to follow very fast winding temperature variations. They achieve their thermal steady state after a few minutes.

**Warning:** To protect correctly the motor against very fast overload, please refer to 3.1.7. Peak current limitations

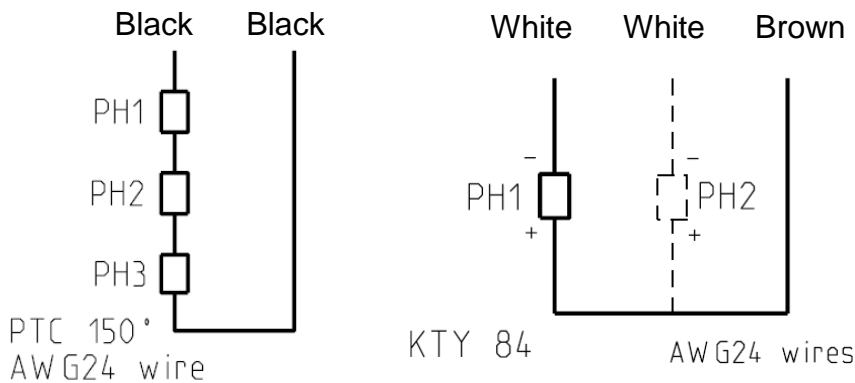

#### 3.7.1. Alarm tripping with PTC thermistors:

The thermal probes (PTC thermistors) fitted in the servomotor winding trip the electronic system at  $150^{\circ} \pm 5^{\circ} \text{C}$ . When the rated tripping temperature is reached, the PTC thermistor resistance changes very quickly. This resistance can be monitored by the drive to protect the motor.

The graph and tab below shows the PTC resistance as a function of temperature ( $T_N$  is nominal temperature)

Temperature	Resistance value
$-20^{\circ}\text{C}$ up to $T_N - 20^{\circ}\text{C}$	$R \leq 750\Omega$
$T_N - 5^{\circ}\text{C}$	$R \leq 1650\Omega$
$T_N + 5^{\circ}\text{C}$	$R \geq 3990\Omega$
$T_N + 15^{\circ}\text{C}$	$R \geq 12000\Omega$

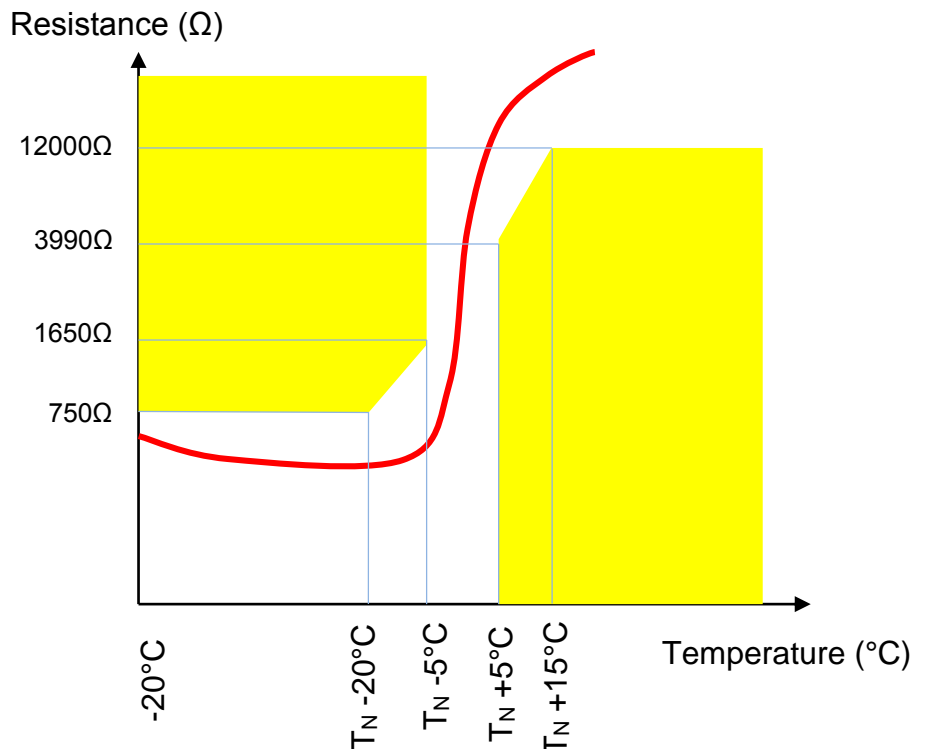

### 3.7.2. Temperature measurement with KTY sensors:

Motor temperature can also be continuously measured by the drive using a KTY 84-130 thermal sensor built in to the stator winding. KTY sensors are semiconductor sensors that change their resistance according to an approximately linear characteristic. The required temperature limits for alarm and tripping can be set in the drive.

The graph below shows the KTY sensor resistance vs temperature, for a current of 2 mA:

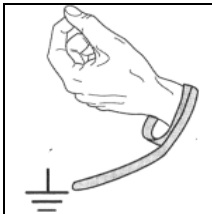
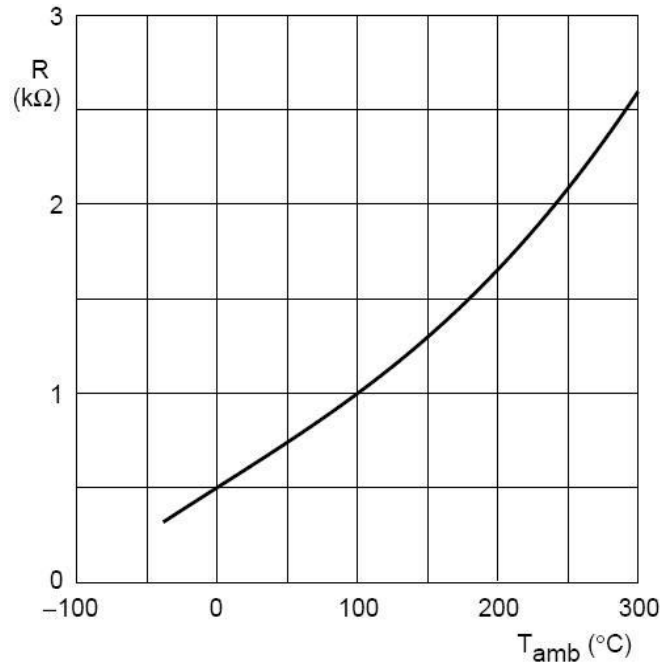

**Warning:** KTY sensor is sensitive to electrostatic discharge. So, always wear an antistatic wrist strap during KTY handling.



**Warning:** KTY sensor is polarized. Do not invert the wires.



**Warning:** KTY sensor is sensitive. Do not check it with an Ohmmeter or any measuring or testing device.

## 3.8. Power electrical connection

---

### 3.8.1. Cables sizes



In every country, you must respect all the local electrical installation regulations and standards.



Cable selection depends on the cable construction, so refer to the cable technical documentation to choose wire sizes



Some drives have cable limitations or recommendations; please refer to the drive technical documentation for any further information.

### Cable selection



At standstill, the current must be limited at 80% of the low speed current  $I_0$  and the cable has to support the peak current for a long period. So, if the motor works at standstill, the current to select the right wire size is  $\sqrt{2} \times 0.8 I_0 \cong 1,13 \times I_0$ .

Conversion Awg/kcmil/mm<sup>2</sup> :

Awg	kcmil	mm <sup>2</sup>
	500	253
	400	203
	350	177
	300	152
	250	127
0000 (4/0)	212	107
000 (3/0)	168	85
00 (2/0)	133	67.4
0 (1/0)	106	53.5
1	83.7	42.4
2	66.4	33.6
3	52.6	26.7
4	41.7	21.2
5	33.1	16.8
6	26.3	13.3
7	20.8	10.5
8	16.5	8.37
9	13.1	6.63
10	10.4	5.26
11	8.23	4.17
12	6.53	3.31
14	4.10	2.08
16	2.58	1.31
18	1.62	0.82
20	1.03	0.52
22	0.63	0.32
24	0.39	0.20
26	0.26	0.13

**3.8.2. Motor cable length**

For motors windings which present low inductance values or low resistance values, the own cable inductance, respectively own resistance, in case of large cable length can greatly reduce the maximum speed of the motor. Please contact PARKER for further information.

	<p><u>Caution:</u> It might be necessary to fit a filter at the servo-drive output if the length of the cable exceeds 25 m. Consult us.</p>
---	---



### 3.8.3. Mains supply connection diagrams

	<p><u>Caution:</u> A bad tightening on the cable or a too small cable section can generate an overheating and damage the motor.</p>
---	---

Parker can provide High Power cables, to be placed between the motor and the drive, with standard lengths of 1, 2, 3 or 4 meters.

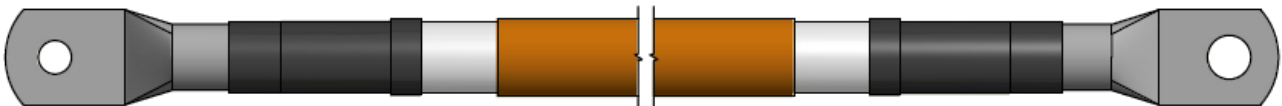

Depending on the rated motor current, indicated on the motor datasheet, 2 cable cross-sections can be proposed as follows :

Drive	Terminal Dri / Mot	Motor Rated Current up to 190 Arms	Motor Rated Current over 190 Arms
MCC	M6 / M6	CBM250H0-RC6-RC6-00x0-00	-
MCD			
MCE	M8 / M6	CBM250H0-RC6-RC8-00x0-00	CBM500H0-RC6-RC8-00x0-00
MCF			
MD-42	M6 / M6	CBM250H0-RC6-RC6-00x0-00	-
MD-44			
MD-46	M8 / M6	CBM250H0-RC6-RC8-00x0-00	CBM500H0-RC6-RC8-00x0-00
MD-4B			

Depending on the required cable length (1, 2, 3 or 4m), the "x" letter of the part number is to be replaced by 1, 2, 3 or 4.

The minimum bending radius is 4 times the cable diameter, for the CMXUG4 = 40 mm ; for the CMXUG0 = 60 mm.

Please note that you can use the same type of cables between the drive and the battery (modifying the terminal on the battery side)

### 3.8.3.1. Motor connection

For Parker High Power cables, please follow the next 5 steps :

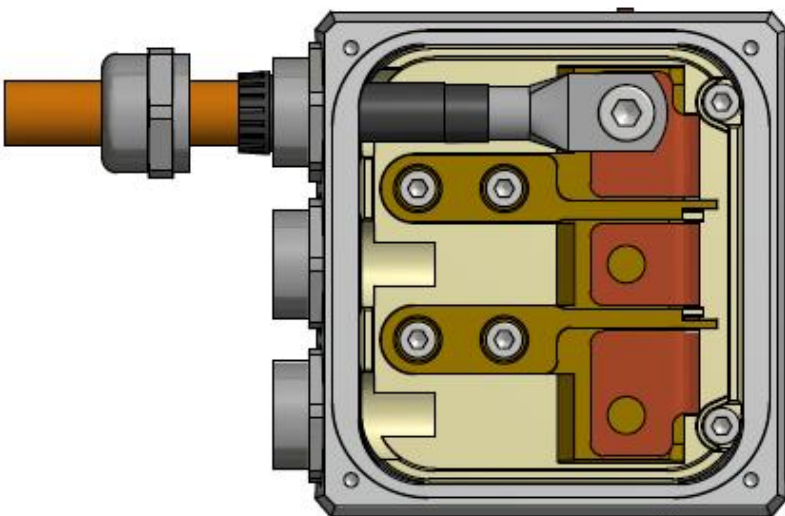
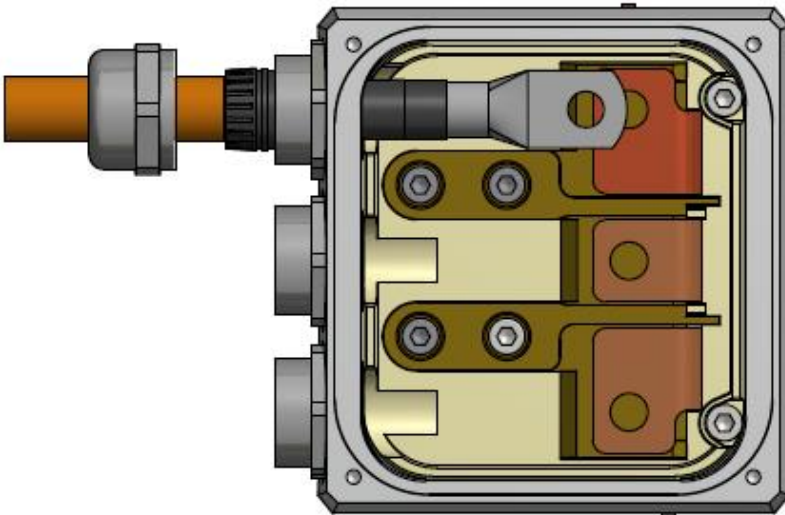
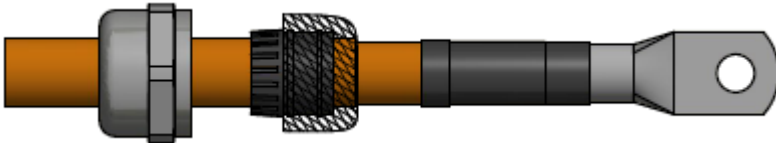

Please use M6 x 10  
to fix the terminals  
(tightening torque :  
see p61)

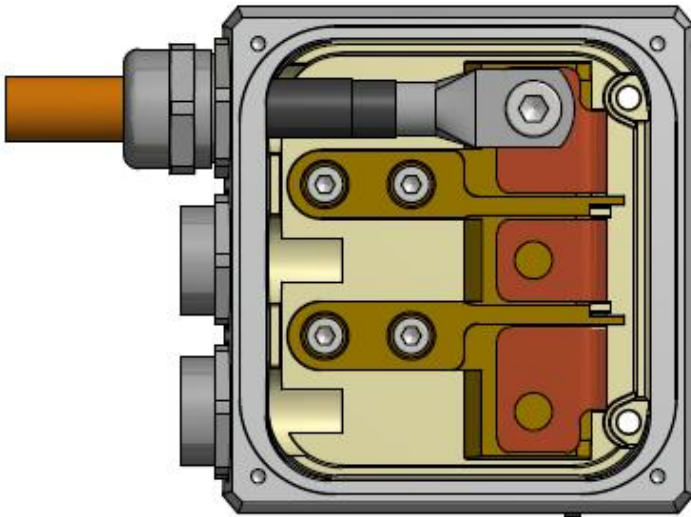

For the specific case of High Voltage Low Power drives :  
 Parker can supply 4 meter length Power cable which part number is HVLP-D-M-CABLE.

To connect the motor, please follow the 7 next steps.

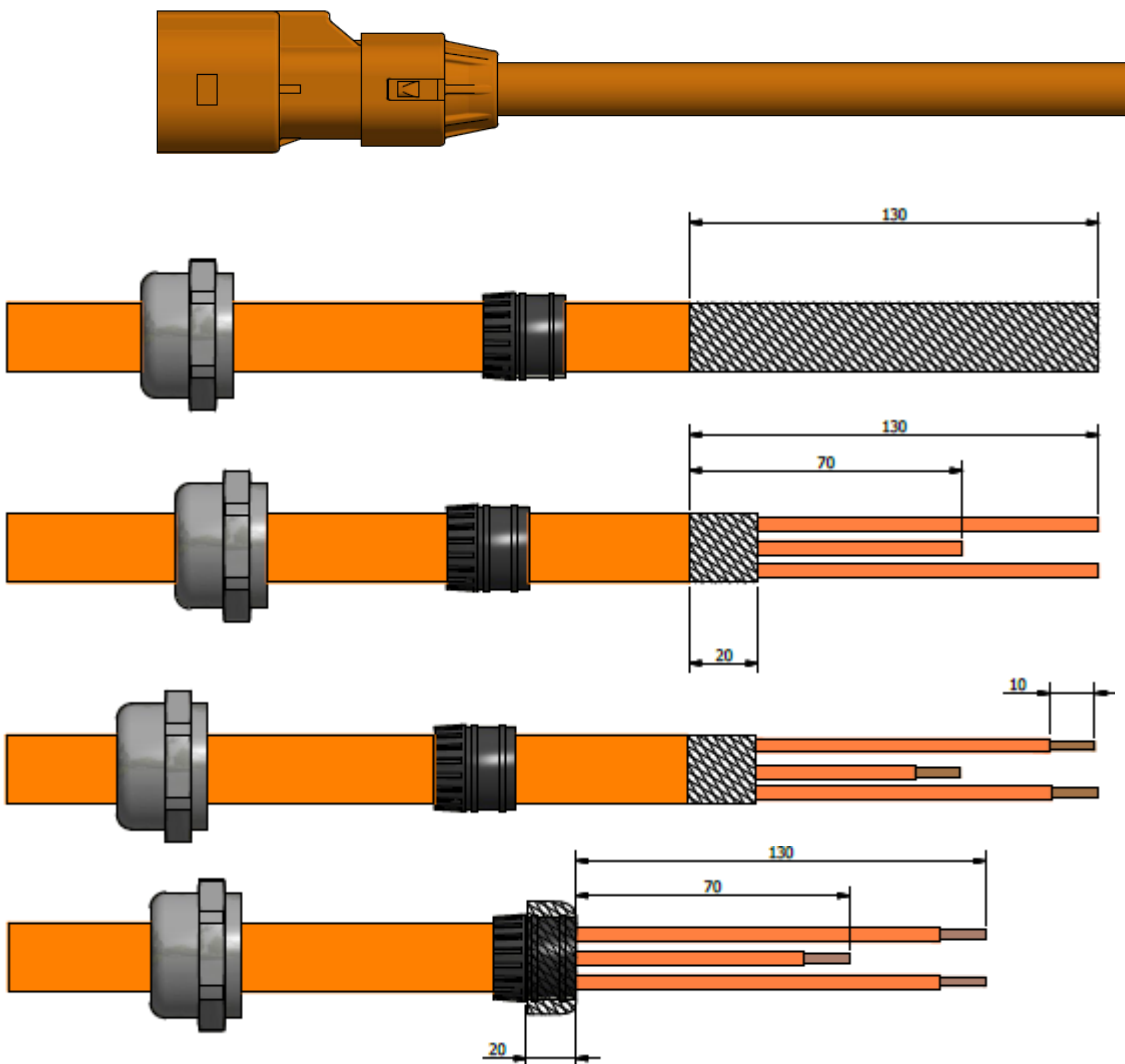

Please use M6 x 10 to fix the terminals (tightening torque : see §4.2.1)

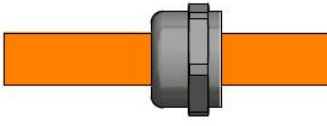

Take care to close non-used cable glands

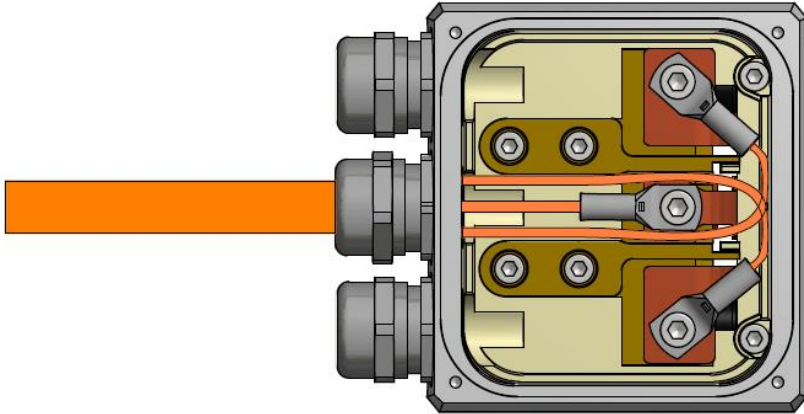
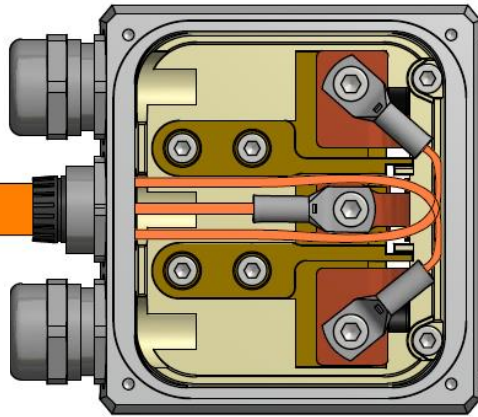

As previously, Parker can provide 4 meter length power cable to take place between the drive and the battery (with 2 interlock wires) which part number is HVLP-B-D-CABLE.

### 3.8.3.2. Vehicle chassis (ground) connection

Use one of the fitting holes for vehicle chassis connection as on the picture below.

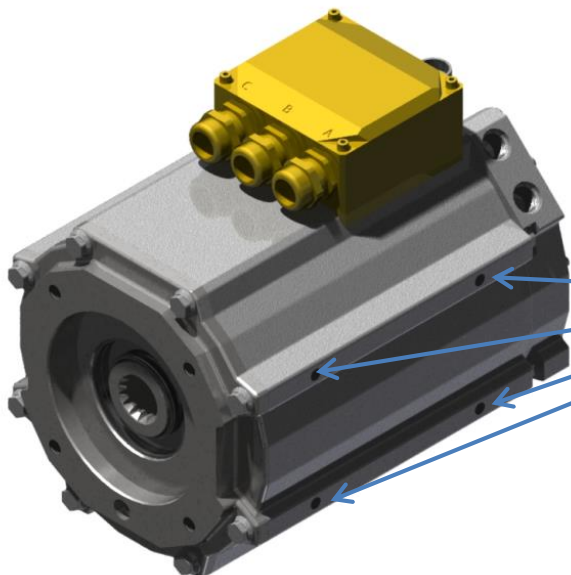

Holes available for grounding connections on 3 motor sides



In every country, you must respect all the local electrical installation regulations and standards to determine the vehicle chassis (ground) cable size.

### 3.9. Feedback system

#### 3.9.1. Resolver

A resolver determines the rotor position.

Its signals are processed by the drive in order to control the stator currents, the speed and the position.

#### Resolver 2 poles transformation ratio = 0.5 – code A

	<b>GVM142</b>	<b>GVM210</b>
Parker part number	220005P1002	220005P1003
Electrical specification	Values @ 8 kHz	
Polarity	2 poles	
Input voltage	7 Vrms	
Input current	86mA maximum	56mA maximum
Zero voltage	20mV maximum	
Encoder accuracy	± 10' maxi	
Ratio	0,5 ± 5 %	
Output impedance (primary in short circuit whatever the position of the rotor)	Typical 100 + 240j Ω	Typical 95 + 180j Ω
Dielectric rigidity (50 – 60 Hz)	500 V – 1 min	
Insulation resistance	≥ 100MΩ	
Rotor inertia	~30 g.cm <sup>2</sup>	~123 g.cm <sup>2</sup>
Operating temperature range	-55 to +155 °C	

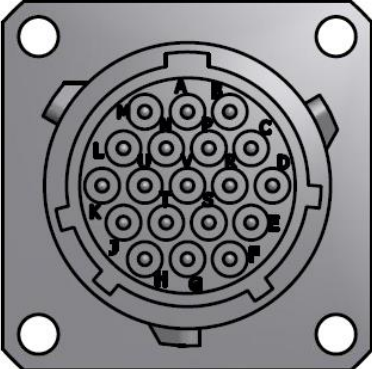
<b>Resolver connector</b>	<b>PIN</b>	<b>Signal</b>
	A	Ref Sin (-) S2
	B	Sin (+) S4
	J	Ref (+) R1
	K	Ref (-) Ground R2
	E	Ref Cos (-) S1
	F	Cos (+) S3
	C	PTC Therm Disconnect (+)
	D	PTC Therm Disconnect (-)
	G	KTY Winding Therm (+)
	H	KTY Winding Therm (-)
	L,M,N,P,R,S,T,U,V	Not Connected

In this case, Parker can provide Resolver Sensor cables, to be placed between the motor and the drive, with standard lengths of 1, 2, 3 or 4 meters ; its part number is built as follows "CBFRE0H0-SRX-000-00x0-00" where "x" is the length in meter.



### 3.9.2. Sin-Cos Encoder (low voltage application)

Parker part number	220285P0002
Electrical specification	Values @ 500 Hz
Input voltage	5 Vrms $\pm$ 5%
Input current	20 mA maximum
Encoder accuracy	$\pm$ 0,5° maxi
Internal serial impedance	720 $\Omega$

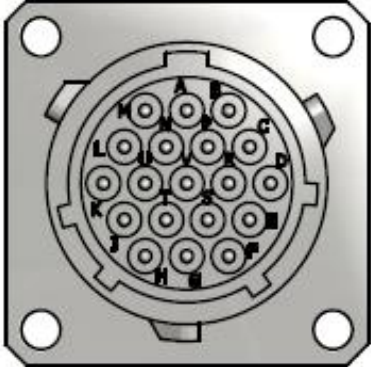
Sin-Cos Encoder connector	PIN	Signal
	A	VA (Cos)
	J	VDD
	K	GND
	E	VB (Sin)
	C	PTC Therm Disconnect (+)
	D	PTC Therm Disconnect (-)
	G	KTY Winding Therm (+)
	H	KTY Winding Therm (-)
	L,M,N,P,R,S,T,U,V	Not Connected

In this case, Parker can provide Encoder Sensor cables, to be placed between the motor and the drive, with standard lengths of 1, 2, 3 or 4 meters ; its part number is built as follows "CBFSC0H0-SRX-000-00x0-00" where "x" is the length in meter.



	<p>In case of SinCos encoder, take care to connect the cable shield to the vehicle chassis. In any case the motor housing must be at the same potential than the drive body.</p>
---	--



## 4. COMMISSIONING, USE AND MAINTENANCE

### 4.1. Reception, handling, storage

#### 4.1.1. Equipment delivery

All the GVM motors are strictly controlled during manufacturing, prior to shipping. Upon receipt it, it is necessary to verify the motor condition and confirm it has not been damaged during transit. Remove it carefully from its packaging. Verify that the data written on the label are the same as the ones on the acknowledgement of order, and that all documents or necessary accessories for user are present in the packaging.



Warning : In case of damaged material during the transport, the recipient must **immediately** make representations to the carrier through a registered mail within 24 h.

#### 4.1.2. Handling

The GVM motors are equipped with threaded holes on its housing for handling.



DANGER: Only use the threaded holes the GVM motors are equipped with for handling operations. Never use cables, connectors, input/output of cooling circuit, or any other inappropriate lifting device.

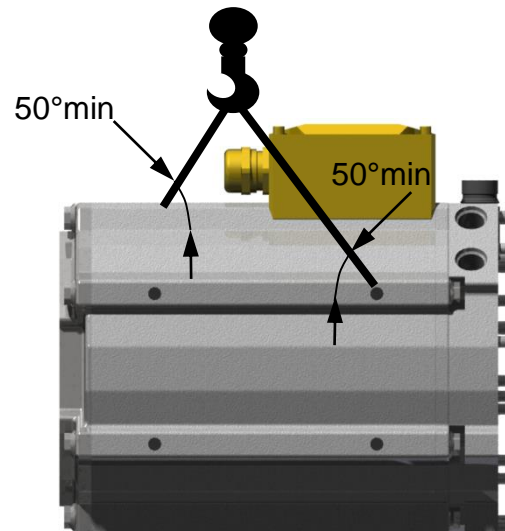
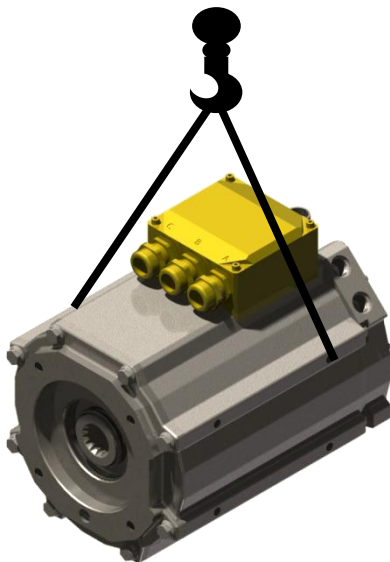

DANGER: Choose the correct slings for the motor weight. The two slings must be the same length and a minimum angle of 50° has to be respected between the motor axis and the slings.



### 4.1.3. Storage

Before being mounted, the motor has to be stored in a dry place, without rapid or significant temperature variations in order to avoid condensation.

If the GVM motor has to be stored for a long time, verify that the shaft end and the flange are coated with corrosion proof product.

After a long storage duration (more than 3 month), run the motor at low speed in both directions, in order to blend and spread the bearing grease.

The motor is delivered with caps for the water inlet and outlet to protect the cooling circuit. Keep them on place until the motor commissioning.

## 4.2. Installation

### 4.2.1. Mounting

Vehicle frame must be even, sufficiently rigid and shall be dimensioned in order to avoid vibrations due to resonance. Before bolting the motor's feet, the foundation surface must be cleaned and checked in order to detect any excessive height difference between the foot locations. In any case we recommend using shims to compensate small irregularities.

	<p><u>Caution:</u> The user bears the entire responsibility for the preparation of the foundation.</p>
--	--

The table below gives the average tightening torques required regarding the fixing screw diameter. These values are valid for both motor's feet and flange bolting.

Screw diameter	Tightening torque
M2 x 0.35	0.35 N.m
M2.5 x 0.4	0.6 N.m
M3 x 0.5	1.1 N.m
M3.5 x 0.6	1.7 N.m
M4 x 0.7	2.5 N.m
M5 x 0.8	5 N.m
M6 x1	8.5 N.m
M7 x 1	14 N.m
M8 x 1.25	20 N.m

Screw diameter	Tightening torque
M9 x 1.25	31 N.m
M10 x 1.5	40 N.m
M11 x 1.5	56 N.m
M12 x 1.75	70 N.m
M14 x 2	111 N.m
M16 x 2	167 N.m
M18 x 2.5	228 N.m
M20 x 2.5	329 N.m
M22 x 2.5	437 N.m
M24 x 3	564 N.m



	<p><u>Warning:</u> After 15 days, check all tightening torques on all screws and nuts.</p>
---	--

### 4.2.2. Preparation

Once the motor is installed, it must be possible to access to the wiring, and read the manufacturer's plate. Air must be able to circulate freely around the motor for cooling purposes.

Clean the shaft using a cloth soaked in white spirit or alcohol. Pay attention that the cleaning solution does not get on to the bearings.

The motor must be in a horizontal position during cleaning or running.

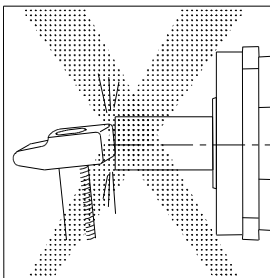

	<p><u>Caution:</u> Do not step on the motor, the connector or the terminal box</p>
	<p><u>Caution:</u> Always bear in mind that some parts of the surface of the motor can reach or exceed 100°C</p>

### 4.2.3. Mechanical assembly







The operational life of motor bearings largely depends on the care and attention given to this operation.

- Carefully check the alignment of the motor shaft with the driven machine to avoid vibrations, irregular rotations or applying too much strain on the shaft.
- Prohibit any impact on the shaft or press fitting which could mark the bearing tracks.
- In the event that the front bearing block is sealed by a lip seal which rubs on the rotating section, we recommend that you lubricate the seal with grease to extend its operational life.

	<p><u>Warning :</u> The user has the entire responsibility to prepare the support, the coupling device, shaft line alignment, and shaft line balancing.</p>
	<p><u>Warning :</u> Parker will not be responsible for any motor shaft fatigue due to excessive strain on the shaft, a bad alignment or bad shaft line balancing .</p>

### 4.3. Electrical connection

---



	<p><u>Warning</u> : Check that the power to the electrical inverter is safely off prior to make any connections.</p>
	<p><u>Warning</u> : The wiring must comply with the inverter commissioning manual, with recommended cables, the standard and the local regulations</p>
	<p><u>Warning</u> : The GVM motor must be grounded by connecting to an unpainted section of the motor.</p>
	<p><u>Warning</u> : Do not open the terminal box under voltage or when the motor is rotating.</p>
	<p><u>Danger</u> : After 15 days, check all tightening torques on cable connection. Bad connections can lead to overheating and fire.</p>

#### 4.3.1. Cable connection

Please, read §3.8 "Electrical connection" to have information about cable and terminal box.

A lot of information are already available in the inverter documentations.

#### 4.3.2. Resolver / Encoder / Thermistor cable handling

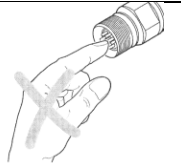
	<p><u>Danger:</u> before any intervention the drive must be stopped in accordance with the procedure.</p>
	<p><u>Caution:</u> It is forbidden to disconnect the Encoder cable under voltage (high risk of damage and sensor destruction).</p>
	<p><u>Warning:</u> Always wear an antistatic wrist strap during encoder handling.</p>
	<p><u>Warning:</u> Do not touch encoder contacts (risk of damage due to electrostatic discharges ESD).</p>

## 4.4. Maintenance Operations

	<p><b>Generality</b>  <b>DANGER:</b> The installation, commissioning and maintenance operations must be performed by qualified personnel, in conjunction with this documentation.</p> <p>The qualified personnel must know the safety local regulations.</p> <p>They must be authorized to install, commissioning and operate in accordance with established practices and standards.</p> <p>Please contact PARKER for technical assistance.</p>
---	--

Operation	Periodicity	Section number
Cooling water quality inspection	Every year	§3.6
Check all tightening torques on all screws in the terminals box	Every year	§4.2
Check the bearings	Every year	§3.5
Clean the motor	Every year	
Inspect and lubricate shaft seals	Every year	§4.2.3
Inspect and lubricate shaft splines	Every year	
Inspect coolant fittings, and hoses	Every year	§3.6
Inspect power and feedback cables	Every year	§4.3

## 4.5. Troubleshooting

We provide hereunder a symptom list in regard with their possible cause. This is not an exhaustive list so in case of trouble, please refer to the associated inverter manual (the diagnostic board indications will help you investigating) or contact us at:

<http://www.parker.com/eme/repairservice>.

<p>You note that the motor does not turn by hand when the motor is not connected to the drive.</p>	<ul style="list-style-type: none"> <li>• Check if the phases are not in short circuit.</li> <li>• Check if the rotor is externally blocked mechanically in rotation.</li> </ul>
<p>You have difficulty starting the motor or making it run</p>	<ul style="list-style-type: none"> <li>• If there is a thermal protector, check it and its connection and how it is set in the drive.</li> <li>• Check the servomotor insulation (in doubt, measure when the motor is hot and cold.</li> </ul> <p>The minimum insulation resistance measured under 500VDC max is 50 MΩ :</p> <ul style="list-style-type: none"> <li>- Between phase wire and housing,</li> <li>- Between thermal protector and housing,</li> <li>- Between resolver winding and housing.</li> </ul>
<p>You find that the motor speed is drifting</p>	<ul style="list-style-type: none"> <li>• Adjust the inverter offset.</li> </ul>
<p>You notice that the motor is racing</p>	<ul style="list-style-type: none"> <li>• Check the speed set-point of the inverter.</li> <li>• Check you are well and truly in speed regulation (and not in torque regulation).</li> <li>• Check the (feedback device) setting</li> </ul>
<p>You notice vibrations</p>	<ul style="list-style-type: none"> <li>• Check the (feedback device) connections, the earth connections (carefully) and the earthing of the earth wire, the setting of the inverter.</li> <li>• Check the stability of the secondary voltages.</li> <li>• Check the rigidity of the frame and motor support.</li> <li>• Check motor fixing on its base.</li> <li>• Check the balancing.</li> <li>• Check the alignment between motor and load.</li> </ul>
<p>You find that the motor is too noisy</p>	<p>Several possible explanations :</p> <ul style="list-style-type: none"> <li>- Unsatisfactory mechanical balancing,</li> <li>- Defective coupling,</li> <li>- Loosening of several pieces,</li> <li>- Poor adjustment of the inverter of the position loop: check rotation with the loop open.</li> <li>- Low drive switching frequency.</li> </ul>